© Copyright Agilent Technologies. 2000

All rights reserved. Reproduction, adaption, or translation without prior written permission is prohibited, except as allowed under the copyright laws.

Agilent Part No. 37718-90217

Printed in U.K. September 2000.

Warranty

The information contained in this document is subject to change without notice.

Agilent Technologies makes no warranty of any kind with regard to this material, including, but not limited to, the implied warranties or merchantability and fitness for a particular purpose.

Agilent Technologies shall not be liable for errors contained herein or for incidental or consequential damages in connection with the furnishing, performance, or use of this material.

WARNING

Warning Symbols Used on the Product



The product is marked with this symbol when the user should refer to the instruction manual in order to protect the apparatus against damage.

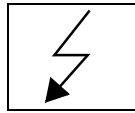

The product is marked with this symbol to indicate that hazardous voltages are present



EN 60825 1991

The product is marked with this symbol to indicate that a laser is fitted. The user should refer to the laser safety information in the Verification manual.

About This Book

OmniBER 718 SDH User Guide

About This Book

This book tells you how to select the features that you want to use for your test.

The selections available are presented in the following groups:

- Transmit and receive interfaces
- Test features, for example, the addition of errors and alarms to the test signal
- Measurements including test timing
- Storing, logging and printing results with general printer information
- Using instrument and disk storage
- Using the “Other” features.

The selections available will depend on the options fitted to your instrument. The examples given in this book cover all options and therefore may include selections which are not available on your instrument.

1 Introduction

- Product Description 14
- Conventions 15
- Connecting to the Network 16
- Cleaning Optical Connectors 19
- Connecting Accessories 20
- Front Panel Soft Recovery (Cold Start) 21
- OmniBER 718 Option Guide 22

2 Setting the Interfaces

- Setting PDH/DSn Transmit Interface
(option 012) 26
- Setting DSn THRU Mode (option 012) 28
- Setting SDH Transmit Interface 29
- Setting Jitter Transmit Interface 34
- Setting Wander Transmit Interface 36
- Setting SDH THRU Mode 38
- Using Smart Test 41
- Setting PDH/DSn Receive Interface
(Option 012) 47
- Setting SDH Receive Interface 49
- Setting Jitter Receive Interface 50
- Setting Extended Jitter Receive Interface 51
- Setting Wander Receive Interface 52

3 Selecting Test Features

Using Transmit Overhead Setup	54
Using Receive Overhead Monitor	56
Setting Overhead Trace Messages	58
Setting Overhead Labels	59
Generating Overhead Sequences	60
Using Receive Overhead Capture	62
Adding Frequency Offset to SDH Signal	64
Adding Frequency Offset to the PDH/DSn Signal	66
Setting up Signaling Bits	67
Setting Transmit Structured Payload/Test Signal	70
Setting Receive Structured Payload/Test Signal	72
Setting Transmit N x 64 kb/s/N x 56 kb/s	
Structured Payload/Test Signal	73
Setting Receive N x 64 kb/s/N x 56 kb/s	
Structured Payload/Test Signal	75
Inserting an External PDH/DSn Payload/Test Signal	76
Dropping an External Payload/Test Signal	79
Adding Errors & Alarms at the SDH Interface	82
Adding Errors & Alarms to a PDH signal	83
Using FEAC Codes	84
Setting PDH Spare Bits	86
Adding Pointer Adjustments	87
Using Pointer Graph Test Function	95
Stressing Optical Clock Recovery Circuits	97
Generating Automatic Protection Switch (APS) Messages	99
Inserting and Dropping the Data Communications Channel	104
Using DS1 LOOP Codes	105

4 Making Measurements

- Using Overhead BER Test Function 110
- Test Timing 111
- Performing a Trouble Scan 112
- Making SDH Analysis Measurements 114
- Making PDH Analysis Measurements 115
- Measuring Frequency 116
- Measuring Optical Power 117
- Measuring Round Trip Delay 118
- Monitoring Signaling Bits 120
- Measuring Service Disruption Time 121
- Performing an SDH Tributary Scan 124
- Performing an SDH Alarm Scan 127
- Performing a PDH/DSn Alarm Scan 128
- Measuring Jitter 129
- Measuring Extended Jitter 131
- Measuring Wander 133
- Measuring Jitter Tolerance 137
- Measuring Jitter Transfer 142
- Measuring Pointer Adjustment (Tributary) Jitter 148

5 ATM Operation

- Setting up the Transmitter for ATM Payloads 154
- Setting up the Convergence Sublayer 157
- Setting Foreground Traffic 159
- Setting Background Traffic 161
- Setting Foreground and Background Distributions 162
- Transmitting ATM Alarms 165

Adding ATM Errors 167
Viewing ATM Results 169
Setting up the Receiver for ATM Payloads 170
Setting up the Receiver ATM signal 172
Policing ATM Traffic 174
Measuring ATM Delay Performance 176
Measuring ATM Alarms 179
ATM Service Disruption 180

6 Packet over SDH (POS)

POS Protocol Stack 184
Setting up the Transmitter for POS Payloads 185
Setting HDLC Framing, Scrambling and HDLC Frame Check Sequence 187
Setting IP Packet (Datagram) Length and Inter-Packet Gap 190
Setting IP Header 192
Setting IP Addresses 193
Setting IP Payload 194
Adding POS Alarms 195
Adding POS Errors 196
Setting up the Receiver for POS Operation 197
Setting up the Receiver POS signal 199
Viewing POS Results 200
POS Applications 201
Channelized Testing 202
Fully Exercising POS Hardware Architecture 204
Throughput Testing 208
Continuity Test 212
POS Service Disruption 215

HDLC Frame Stuffing 218
Jitter Tolerance Testing of POS Equipment 221

7 Tandem Connection Monitoring

Tandem Connection Monitoring (TCM) 226
Setting up the Transmitter for TCM Operation 227
Setting up TCM Access Point Identifier (APId) messages 228
Adding TCM errors 230
Adding TCM Alarms 231
Setting up the Receiver for TCM operation 232
Detecting TCM APId messages 233
Viewing TCM Errors and Alarms 235
Tandem Connection Terminating Equipment (TCTE) Testing 237

8 Storing, Logging and Printing

Saving Graphics Results to Instrument Store 244
Recalling Stored Graph Results 245
Viewing the Bar Graph Display 247
Viewing the Graphics Error and Alarm Summaries 249
Logging Graph Displays 251
Logging Results 253
Logging on Demand 261
Logging Jitter Tolerance Results 264
Logging Jitter Transfer Results 266
Logging Results to Parallel (Centronics) Printer 267
Logging Results to GP-IB Printer 268

Logging Results to Internal Printer 269
Logging Results to RS-232-C Printer 270
Printing Results from Disk 271
Connecting a Printer to a Parallel Port 272
Changing Internal Printer Paper 273
Cleaning Internal Printer Print Head 276

9 Using Instrument and Disk Storage

Storing Configurations in Instrument Store 278
Titling Configuration in Instrument Store 279
Recalling Configurations from Instrument Store 280
Formatting a Disk 281
Labeling a Disk 282
Managing Files and Directories on Disk 283
Saving Graphical Results to Disk 290
Saving a Screen Dump to Disk 292
Saving Data Logging to Disk 294
Saving Configurations to Disk 295
Recalling Configuration from Disk 296
Recalling Graphics Results from Disk 297
Copying Configuration from Instrument Store to Disk 298
Copying Configuration from Disk to Instrument Store 300
Copying Graphics Results from Instrument Store to Disk 302

10 Selecting and Using "Other" Features

Coupling Transmit and Receive Settings 306

Setting Time & Date 307
Enabling Keyboard Lock 308
Enabling Beep on Received Error 309
In-Band DS1 Loopcode 156MTS Compatibility 310
Suspending Test on Signal Loss 311
MS-REI Result/Enable 312
MS-AIS Result/Enable 313
Graph Storage Resolution 314
Setting Error Threshold Indication 315
Setting Screen Brightness and Color 316
To Generate a New Jitter Mask 317
To change the parameters of a User-defined jitter mask 319
Running Self Test 321
Trigger Output 324

11 AU-3/TUG-3 Background Patterns

12 ETSI/ANSI Terminology

ETSI/ANSI Conversion and Equivalent Terms 330

13 Glossary of Terms

1

"Product Description " page 14

"Conventions " page 15

"Connecting to the Network " page 16

"Connecting Accessories " page 20

"Front Panel Soft Recovery (Cold Start) " page 21

"OmniBER 718 Option Guide " page 22

Introduction

Product Description

Product Description

The OmniBER Communications Performance Analyzer provides all the test capability you need to fully verify the performance of today's high-capacity transmission systems and networks.

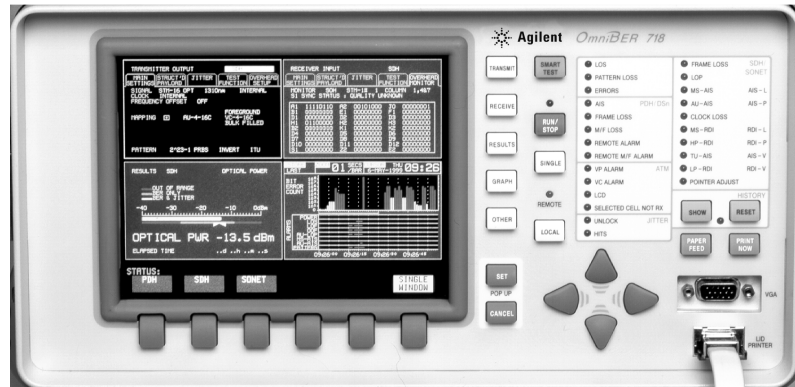

The main features of a dual standard (SDH/SONET) instrument are as follows:

- Multi-rate BER and jitter testing from 64 kb/s to 2.5 Gb/s (STM-16/OC-48).
- Concatenated payloads testing to STM-16c.
- Full PDH/T-carrier testing.
- Direct measurement of protection switching time.
- Powerful thru-mode testing for SDH/SONET ring turn-up.
- Comprehensive SDH/SONET overhead testing.
- Packet over SONET/SDH (POS) and ATM payloads up to 2.5 Gb/s.
- Fast access to key measurement tasks via Smart Test.
- Optical power and line frequency measurements.
- J0 section trace for DWDM testing
- J1 and J2 path trace for network path testing
- Optional integrated graphical printer
- Line frequency offset
- Transmit and Receive can be independently configured.

Conventions

Conventions

The conventions used in this manual to illustrate instrument keys and display information are as follows:

TRANSMIT

This is an example of a hardkey. Hardkeys (located to the right of the display) are used to give access to different sets of instrument settings, or select dedicated instrument functions. The key shown here displays the transmit settings.

PARALLEL

This is an example of a softkey. Softkeys (located below the display) are used to select instrument settings. The values associated with softkeys change as you move the display cursor from one instrument setting to another.

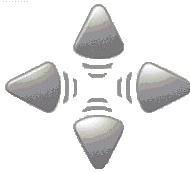

These are the cursor control keys. They are used to move the display cursor from one instrument setting to another.



This is an example of a pop-up menu. Pop-up menus are an alternative way of selecting instruments settings (instead of using softkeys). To access a pop-up menu, highlight an instrument setting, then use the **SET** key.



This symbol (when it appears next to settings on the display) indicates that there is a pop-up menu associated with the instrument setting. To access a pop-up application, highlight the instrument setting which has this symbol, then use the **SET** key.



This symbol appears at the bottom right of the display when an optical transmit module is fitted to the instrument. The symbol's background changes from black to yellow when the optical output is switched on.

Connecting to the Network

Connecting to the Network

The network connectors are located on the modules at the side of the instrument. The connections available depend on the options fitted to your instrument.

Before connecting, note the Warning and Caution information given.

All Connectors

CAUTION

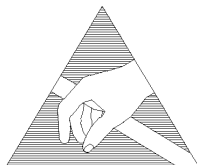

When connecting or disconnecting, ensure that you are grounded or, make contact with the metal surface of the Mainframe with your free hand to bring you, the module, and the mainframe to the same static potential.

Modules remain susceptible to ESD damage while the module is installed in the Mainframe

Additional ESD information is required when servicing, see your Installation/ Verification manual for further information.

Optical Interface Connectors

For your protection, review all laser information given in this manual and the Verification manual before installing or using the instrument.

WARNING

To prevent personal injury, avoid use that may be hazardous to others, and maintain the module in a safe condition Ensure the information given below is reviewed before operating the module.

Laser Product Classification

All optical modules are classified as Class I (non-hazardous) laser product in the USA which complies with the United States Food and Drug Administration (FDA) Standard 21 CFR Ch.1 1040.10, and are classified as Class 1 (non-hazardous) laser products in Europe which complies with EN 60825-1 (1994).

To avoid hazardous exposure to laser radiation, it is recommended that the following practices are observed during system operation:

Connecting to the Network

- **ALWAYS DEACTIVATE THE LASER BEFORE CONNECTING OR DISCONNECTING OPTICAL CABLES.**
- When connecting or disconnecting optical cables between the module and device-under-test, observe the connection sequences given below.
Connecting: Connect the optical cable to the input of the device-under-test **before** connecting to the module's *Optical Out* connector.
Disconnecting: Disconnect the optical cable from the module's *Optical Out* connector **before** disconnecting from the device-under-test. Always fit the fibre optic connector dust caps over the laser aperture.
- NEVER examine or stare into the open end of a broken, severed, or disconnected optical cable when it is connected to the module's *Optical Out* connector.
- Arrange for service-trained personnel, who are aware of the hazards involved, to repair optical cables.

CAUTION

1. Use of controls or adjustments or performance of procedures other than those specified herein may result in hazardous radiation exposure.
 2. Always fit the fibre optic connector dust caps on each connector when not in use. Before connection is made, *always* clean the connector ferrule tip with acetone or alcohol and a cotton swab. Dry the connector with compressed air. Failure to maintain cleanliness of connectors is liable to cause excessive insertion loss.
-

Laser Warning Symbols

The front panel of the optical module has the following label:

CLASS 1 LASER PRODUCT

NOTE

CLASS 1 LASER PRODUCT translates as follows:

Finnish - LUOKAN 1 LASERLAITE

Finnish/Swedish - KLASSE 1 LASER APPARAT

This label indicates that the radiant energy present in this instrument is non-hazardous.

Connecting to the Network

OPTICAL IN

Allows connection of an optical signal, wavelength 1200 to 1600 nm, at a maximum power level of -8 dBm (37718A 2.5 Gb/s) or -3 dBm (37718B/C).

NEVER EXCEED +3 dBm.

Accepts STM-0, STM-1, STM-4 and STM-16. Also accepts SONET signals OC-1, OC-3, OC-12, and OC-48 depending on the model and options fitted.

OPTICAL OUT

Provides an STM-0, STM-1, STM-4 or STM-16 optical signal (OC-1, OC-3, OC-12 or OC-48 SONET signals) at wavelength 1280 to 1335nm, and/or 1480 to 1580 nm, at a nominal power level of +1 dBm depending on model and options.

Cleaning Optical Connectors

Cleaning Optical Connectors

It is recommended that the optical connectors be cleaned at regular intervals using the following materials:

Description	Part Number
Blow Brush	9300-1131
Isopropyl Alcohol	8500-5344
Lens Cleaning Paper	9300-0761
Adhesive Tape Kit	15475-68701

CAUTION

Do not insert any tool or object into the IN or OUT ports of the instrument as damage to or contamination of the optical fibre may result.

- 1 Recall Default settings (STORED SETTINGS 0) and remove the power from the OmniBER 718.
- 2 Remove the adapters from the IN and OUT ports. Use an 11 mm spanner to slacken the nut securing the adapter. On re-assembly tighten the nut using a torque spanner to 1.5 Nm.
- 3 Using the blow brush with the brush removed blow through the ferrule of the standard flexible connector and the adapter.

CAUTION

If the optical fibre of the fixed connector requires further cleaning this entails disassembly of the module which should only be carried out by suitably trained service personnel.

- 4 Apply some isopropyl alcohol to a piece of the cleaning paper and clean the barrel of the adapter. Using a new piece of cleaning paper, clean the face of the adapter. Repeat this operation, using a new piece of cleaning paper each time.
- 5 Lightly press the adhesive side of the tape provided against the front of the adapter, then remove it quickly - repeat twice. This removes any particles of cleaning paper which may be present.
- 6 Replace the adapters on the flexible connector.

Connecting Accessories

Connecting Accessories

LID Provides the output for the option 602 printer which is fitted in the cover (lid) of the instrument.

VGA Provides the output for a display monitor.

HANDSET Allows connection of a telephone handset for communication across the network.

Printer
HP-IB (GPIB),
RS232,
PARALLEL ONLY External printer connection details are given in Chapter 6.
The port selected for external printer use is not available for remote control.

Remote Control
HP-IB (GPIB),
RS232,
10 BASE -T Remote control connection is given in the Remote Control Manual.
The port selected for remote control use is not available for an external printer.

10 Base-T Lan Connection Radiated Emissions

To ensure compliance with EN 55011 (1991) a category 5, STP patch lead, RJ45 cable should be used to connect the LAN port on the processor module marked "10 Base-T".

Front Panel Soft Recovery (Cold Start)

Front Panel Soft Recovery (Cold Start)

Use the following procedure if you need to perform a front panel soft recovery (i.e. cold start) of the instrument.

Soft Recovery Procedure

- 1 Switch off the instrument.
- 2 On the instrument front panel - press and hold softkeys 0 and 4 simultaneously (the softkeys immediately below the display; key 0 is on the extreme left).
- 3 Power up the OmniBER 718 while holding the softkeys pressed.
- 4 When the LOS LED has flashed OFF and then ON again, the keys can be released.
- 5 The LOS LED will flash OFF/ON again several times (7), followed by an audible 'beep' and the display indicating 'Initializing Instrument'.
- 6 Once the initialization is complete the display will indicate:
'Firmware Revision Update'
'Default settings assumed'
Hit any key to attempt restart'
- 7 Hit any key, then wait approximately 10 seconds. The instrument should return to its default settings and normal operation.

OmnIBER 718 Option Guide

This guide explains the features offered with each OmnIBER Mainframe and its associated options. There are three mainframes as follows:

- The 37718A
- The 37718B
- The 37718C

The instrument test interfaces are:

2.5 Gb/s, 622 Mb/s, 155 Mb/s, 52 Mb/s, DS1 (1.5 Mb/s), DS3 (45 Mb/s), E1 (2 Mb/s), E2 (8Mb/s), E3 (34 Mb/s).

Mainframe test rate capability

Mainframe	Test Rate Capability
37718A	2.5 Gb/s, 622 Mb/s, 155 Mb/s and 52 Mb/s
37718B	622 Mb/s, 155 Mb/s and 52 Mb/s
37718C	155 Mb/s and 52 Mb/s

Note that 52 Mb/s and 155 Mb/s electrical testing is included in the base mainframe.

SDH/SONET Interface

Interface	Option
SDH only	001
Dual standard SDH/SONET	002

OmniBER 718 Option Guide

Tributary test options

	Option
PDH/T-carrier DS1, DS3, 2 Mb/s, 8 Mb/s, 34 Mb/s and 140 Mb/s	012
2 Mb/s into DS3 mapping (also requires option 012)	014
Replaces BNC connector with WECO 560	620

Optical interface

An optical interface must be ordered if an 37718A or 37718B is required.

	Option
1310 nm only	104
1550 nm only	105
Dual wavelength 1310 nm/1550 nm	106
Replaces FC/PC adapters with SC	610
Replaces FC/PC adapters with ST	611

Jitter

	Option
Adds jitter to all rates	200

OmnibER 718 Option Guide

ATM/POS

	Option
ATM payloads (requires option 350)	300
POS payloads (requires option 350)	310
Advanced payload engine	350

Please note that in earlier versions of the OmnibER the list of ATM options included options 300, 301 and 302. These options have now been merged into one ATM option 300 (as listed above). A new Advanced payload engine option 350 has been added which must be ordered with an ATM or POS option.

Accessory options

	Option
Remote Omnibook controller	600
RS-232-C, GPIB and LAN remote control interfaces	601
80-column in-lid printer	602

"Setting PDH/DSn Transmit Interface (option 012) " page 26

"Setting SDH Transmit Interface " page 29

"Setting Jitter Transmit Interface " page 34

"Setting Wander Transmit Interface " page 36

"Setting SDH THRU Mode " page 38

"Using Smart Test" page 41

"Setting PDH/DSn Receive Interface (Option 012) " page 47

"Setting SDH Receive Interface " page 49

"Setting Jitter Receive Interface " page 50

"Setting Extended Jitter Receive Interface " page 51

"Setting Wander Receive Interface " page 52

Setting the Interfaces

This chapter tells you how to set the instrument interfaces to match the network being tested.

Setting PDH/DSn Transmit Interface (option 012)

Description

PDH transmit interface settings should match network equipment settings of Rate, Termination and Line Code and determine the Payload to be tested.

TIP:

To set the Transmitter and Receiver to the same interface settings choose **OTHER SETTINGS CONTROL COUPLED**.

TRANSMITTER OUTPUT		[PDH/DSn]
MAIN SETTINGS	STRUCT'D SETTINGS	JITTER TEST FUNCTION
SIGNAL CLOCK [INTERNAL]		[2 Mb/s]
TERMINATION		[75Ω UNBAL]
LINE CODE		[HDB3]
FREQUENCY OFFSET		[OFF]
PAYLOAD TYPE [UNFRAMED]		UNSTRUCTURED
PATTERN		[2 ¹⁵ -1 PRBS]
PRBS POLARITY		[INU] ITU
INTERNAL	EXTERNAL	STM-0 RECEIVE
		STM-0 OPT REC
	

HOW TO:

- 1 Choose the required SIGNAL rate from 2 Mb/s, 8 Mb/s, 34 Mb/s, 140 Mb/s PDH, plus DS1, DS3 T-carrier interfaces.
- 2 Choose the required CLOCK SYNC source, internally generated, externally generated or recovered from the received PDH signal. If you select an external clock source, connect the external source to the appropriate port on the OmniBER clock module.
- 3 If a DS1 or DS3 SIGNAL is chosen, choose the required OUTPUT LEVEL.
- 4 If you have chosen 2 Mb/s as the SIGNAL rate, choose the required TERMINATION. (At all other signal rates the impedance is fixed).
- 5 If you have chosen 2 Mb/s, DS1 or 8 Mb/s as the SIGNAL rate, choose the required LINE CODE. (At 34 Mb/s, 140 Mb/s and DS3 coding is fixed.)
- 6 If required, choose the FREQUENCY OFFSET value see “Adding Frequency Offset to the PDH/DSn Signal” page 66.

Setting the Interfaces

Setting PDH/DSn Transmit Interface (option 012)

7 Choose the required PAYLOAD TYPE.

If **STRUCTURED** is required **FRAMED** must be chosen .

If **STRUCTURED** is chosen the PDH test signal must be set up. See “Setting Transmit Structured Payload/Test Signal” page 70.

If you have chosen 2 Mb/s, DS1 or DS3 as the PDH/DSn signal rate, the Framed choice is expanded to provide a menu of framing types.

At 2 Mb/s if you select PCM30 or PCM30CRC framing a field is displayed enabling 2M CAS ABCD bits to be set. See “Setting up Signaling Bits” page 67

Choose the PATTERN type and the PRBS POLARITY.

Additional Patterns at DS1

8 If you select a DS1 SIGNAL, two 8-bit patterns and a 55 Octet pattern are added to the list of available patterns. The 8-bit patterns are as follows:

Table 1 **8-Bit Patterns**

Type	Pattern
1-in-8	F01000000
2-in-8	F01100000

Note 1: F indicates the position of the framing bit with respect to the 8-bit pattern when the framed data is generated

Note 2: Both 8-bit patterns and the 55 Octet pattern can only be selected as a payload for the whole DS1, i.e. they can not be selected as a pattern for an individual 64 kb/s channel.

Note 3: Bit errors can be added to both 8-Bit and 55 Octet test patterns as with the other available test patterns.

The 55 Octet pattern uses the Daly pattern as per ANSI T1.403

Setting the Interfaces
Setting DS_n THRU Mode (option 012)

Setting DS_n THRU Mode (option 012)

Description

THRU mode is used to non-intrusively monitor DS_n lines where no protected monitor points are available.

Note that since THRU mode locks some user settings, you must set SIGNAL RATE (DS1 or DS3), before selecting THRU mode.

Two modes of operation are possible:

Monitor Mode: This is when the Entire Frame Error Rate field is set to **OFF**. In this mode the received signal is passed through or transmitted unchanged, and the instrument monitors errors and alarms as normal DS1 operation.

Full Frame Overwrite Mode: In this mode any bit in the entire frame can be errored at a user defined rate. The bit that is errored can be any bit in the frame, including the frame bit (hence the title of “Full Frame Overwrite”). The error rates available are:

Data error rates: 1.0E-3, 1.0E-4, 1.0E-5, 1.0E-6, 1.0E-7 and user programmable in 0.1 steps from 1.1E-3 to 1.0E-9.

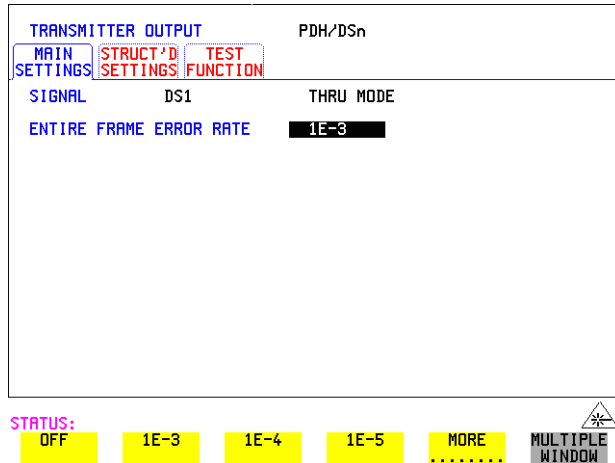

HOW TO:

- 1 Make the required SIGNAL RATE choice on the PDH/DS_n **TRANSMIT** and **RECEIVE** displays.
- 2 Select THRU MODE as shown in the figure above.
- 3 Select an entire frame error rate from the choices given or use the USER softkey to program an error rate.

Setting SDH Transmit Interface

Payload Selection

One of the key features of the OmniBER 718 is the ability to test concatenated payloads, read the following for a brief description of concatenated payloads, and the benefits of using them.

Concatenated Payloads

Bulk filled or contiguous payload structures e.g. (STM-4c) are designed for carrying broadband services. The entire payload area is used to carry the service with no structured mapping or channelization.

In the case of a concatenated STM-4 (denoted STM-4c), the virtual container area is entirely filled by a single VC-4-4c. This VC-4-4c consists of one Path Overhead and a single container capable of carrying a tributary signal at rates up to approximately 600 Mb/s. Once assembled a VC-4-4c is multiplexed, switched and transported through the network as a single entity.

Benefits: Test the entire bandwidth in one go, and reduce test times. The following table illustrates the reduced test times using concatenated payloads.

Table 2 Test times using concatenated payloads

	Test Time (based on 100 errors)	
Performance test limit	STM-4c Container	STM-1 Bulk Payload
10^{-14}	12 days	48 days
10^{-13}	1.2 days	4.8 days
10^{-12}	2.90 hours	11.6 hours
10^{-11}	0.3 hour	1.2 hour
10^{-10}	1.75 minutes	7 minutes

Setting the Interfaces

Setting SDH Transmit Interface

Description

SDH transmit interface settings should match the network equipment settings of Rate, Wavelength and Mapping, determine the payload to be tested and set background conditions to prevent alarms while testing.

Laser On/Off selection (see display below)

Always switch off the laser before connecting or disconnecting optical cables.

TIP:

If you wish to set the OmniBER 718 transmitter and receiver to the same interface settings choose **OTHER** **SETTINGS CONTROL** **COUPLED**.

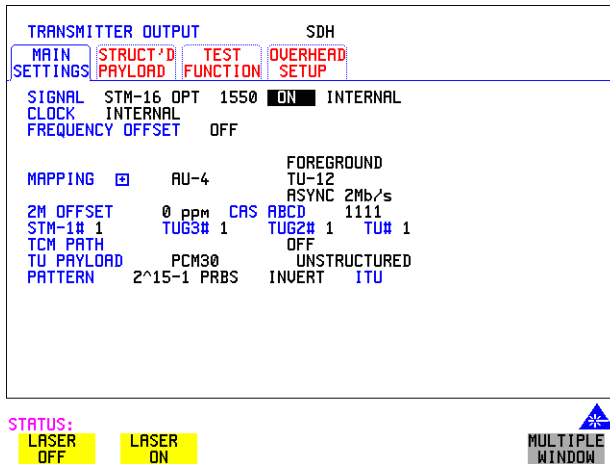

HOW TO:

- 1 Make your choice of SIGNAL rate.
If Option 106, Dual Wavelength optical module, is fitted and an optical rate is chosen, choose the required wavelength (1550 or 1310).
If STM-0 is chosen, choose the required interface level.
Choose **INTERNAL** unless **THRU MODE** is required. If **THRU MODE** is chosen, see "Setting SDH THRU Mode " page 38.
- 2 Make your choice of CLOCK synchronization source. The clock can be internally sourced from the instrument, recovered from the signal at the optical RECEIVE port or externally sourced from the CLOCK REF IN ports (MTS 64 kb/s, BITS 1.5 Mb/s or 10 MHz REF).
- 3 If required choose the FREQUENCY OFFSET value. See "Adding Frequency Offset to SDH Signal" page 64.
- 4 Choose the required **F/G MAPPING** and PAYLOAD TYPE, then

Setting the Interfaces

Setting SDH Transmit Interface

B/G MAPPING and BACKGROUND selection. The FOREGROUND selection is the channel that is chosen for test purposes. The BACKGROUND patterns are not used for test purposes and are either the same as the test channel or set to UNEQUIPPED.

Mapping may be selected from a pictorial display by moving the cursor to MAPPING and pressing **SET**.

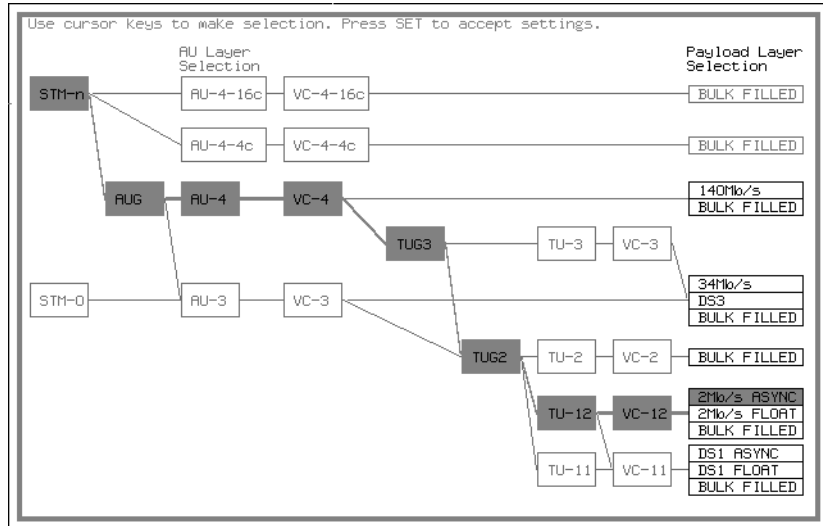

STATUS:



Use **→** and **←** to move between AU Layer Selection, TU Layer Selection and Payload Layer Selection. Use **↑** and **↓** to set the mapping and **SET** to set your selection.

- 5 If TU-2 mapping is chosen, TU CONCATENATION selection is enabled. Choose **OFF** or the tributary at which the concatenation begins (TU2-2C through TU2-6C).
The BACKGROUND, PATTERN IN OTHER TU2s is fixed at NUMBERED, that is, each TU-2 contains a unique number to allow identification in case of routing problems.
- 6 If required, choose DS1/2M/34M/DS3/140M OFFSET value. See "Adding Frequency Offset to SDH Signal" page 64
- 7 If TU-3, TU-2, TU-12 or TU-11 mapping is chosen, choose the test tributary, including the STM-1 for an STM-4/STM-16 signal.

Setting the Interfaces

Setting SDH Transmit Interface

- 8 Choose the payload framing under PAYLOAD TYPE or TU PAYLOAD.
If **STRUCTURED** is required **FRAMED** must be chosen.
If **STRUCTURED** is chosen, the Payload test signal must be set up. See “Setting Transmit Structured Payload/Test Signal” page 70.
If **INSERT** is chosen, see “Inserting an External PDH/DSn Payload/Test Signal” page 76.
If you have chosen 2 Mb/s, DS1 or DS3 under Mapping, the Framed choice is expanded to provide a menu of framing types.
- 9 If 2 Mb/s framing **PCM30** or **PCM30CRC** is chosen, set the CAS ABCD bit values. See "Setting up Signaling Bits " page 67
- 10 Choose the PATTERN type and PRBS polarity. See Note below.
- 11 Choose the mapping required in the background (non-test) TUG-3s. Refer to Appendix A for a table of background patterns for AU-3 and TUG-3.
- 12 If TU-12 mapping is chosen for the test TUG-3, choose the PATTERN IN OTHER TU-12s.

TRANSMITTER OUTPUT		SDH		
MAIN SETTINGS	STRUCT'D PAYLOAD	JITTER	TEST FUNCTION	OVERHEAD SETUP
SIGNAL	STM-16	DPT 1550	ON	INTERNAL
CLOCK	INTERNAL			
FREQUENCY OFFSET		OFF		
BACKGROUND AU-4's		BACKGROUND		
		UNEQUIPPED		
TUG3 NO.2	TU12 MAP			
TUG3 NO.3	TU3 WORD	10101010		
PATTERN IN OTHER TU-12s		2^9-1 PRBS		

STATUS:



NOTE

The definition of NORMAL and INVERTed polarity differs between ITU-T O.150 and common practice usage in the United States of America for 2¹⁵-1 and 2²³-1 PRBS patterns.

Setting the Interfaces

Setting SDH Transmit Interface

The PRBS polarity control allows the user to select which definition is used on the TRANSMITTER and RECEIVER windows.

The ITU-T O.150 standard specifies that the NORMAL or default for all PRBS patterns should be inverted. This will produce a longest string of n-1 consecutive zeros in a 2^n-1 PRBS pattern. Therefore selecting INVERT with an ITU-T pattern will produce a longest string of n-1 consecutive ones in a 2^n-1 pattern.

The ITU-T definition also applies in the US, except for $2^{15}-1$ and $2^{23}-1$ PRBS patterns. Through common practice, NORMAL indicates that the PRBS pattern is non-inverted. Therefore when the 'US' PRBS polarity control is enable and NORMAL is selected for these two patterns on the TRANSMITTER, a longest string of n-1 consecutive ones is produced. The pattern has to be INVERTed in order to produce a longest string of n-1 consecutive zeros.

Choose the mapping required in the background (non-test) STS's. Refer to Appendix A for a table of background patterns for STS-1 SPE.

Setting the Interfaces

Setting Jitter Transmit Interface

Setting Jitter Transmit Interface

Description:
Option 200 required for Jitter and option 012 for PDH.

You can add jitter to the transmitted PDH/DSn or SDH signal at 2 Mb/s, 8 Mb/s, 34 Mb/s, 140 Mb/s, DS1, DS3, STM-0, STM-1, STM-4 and STM-16. Jitter modulation can be sourced internally or from an external source. Jitter measurement up to 2.5 Gb/s is also available when ATM is selected as a payload.

TRANSMITTER OUTPUT		SDH
MAIN SETTINGS	STRUCT'D PAYLOAD	JITTER
		TEST FUNCTION
		OVERHEAD SETUP
JITTER / WANDER		JITTER
JITTER		ON
SIGNAL FREQUENCY		622Mb/s
MODULATION SOURCE		INTERNAL
JITTER CONTROL		OFF
RANGE		20.0 UI
MODULATION FREQUENCY		14 Hz
AMPLITUDE		15.00 UI

STATUS:



MULTIPLE WINDOW

HOW TO:

- 1 If you are adding jitter to the PDH signal, set up the PDH transmit interface. See "Setting PDH/DSn Transmit Interface (option 012) " page 26.
- 2 If you are adding jitter to the SDH signal, set up the SDH transmit interface. See "Setting SDH Transmit Interface " page 29.
- 3 Choose JITTER/WANDER **JITTER** .
If you wish to add wander to the PDH or SDH signal, see "Setting Wander Transmit Interface " page 36.
- 4 Choose JITTER **ON** .
If you wish to perform a Jitter Tolerance measurement, choose **AUTO TOLERANCE** . See "Measuring Jitter Tolerance" page 137.
If you wish to perform a Jitter Transfer measurement choose **TRANSFER FUNCTION** . See "Measuring Jitter Transfer " page 142.

Setting the Interfaces

Setting Jitter Transmit Interface

5 Choose the modulation source.

If adding jitter to the PDH signal and **EXTERNAL** is chosen, connect the external source to the MOD IN port of the JITTER module. Up to 10 UI (20 UI for DS1/DS3) of external jitter modulation can be added at the MOD IN port. If adding jitter to the SDH signal and **EXTERNAL** is chosen, connect the external source to the MOD IN port of the JITTER module. Up to 20 UI of external jitter modulation can be added at the MOD IN port.

6 If you have selected an **INTERNAL** Modulation Source, choose the JITTER CONTROL setting required.

You can choose the jitter range, jitter modulating frequency and jitter amplitude if **OFF** is chosen.

If you choose **SWEPT**, the OmniBER 718 will "sweep" through the ITU-T jitter mask (G.823 for PDH; GR.499 or G.824 for DS_n; G.958, G.825 or GR.253 for SDH) adjusting the jitter amplitude according to the jitter frequency. With the **SWEPT** field selected, press SET on the instrument front panel for a display of the jitter mask sweep (an example is given below).

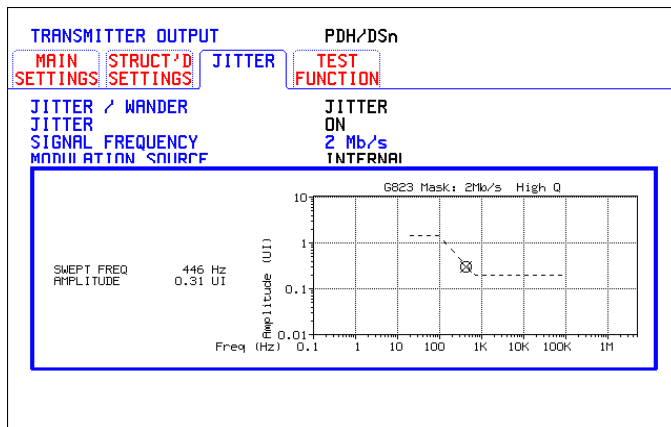

STATUS: Jitter mask sweep in progress



If you choose **SPOT**, you can choose the "spot" jitter frequency. The jitter amplitude is adjusted and controlled according to your jitter frequency choice.

TIP:

If, when using the SWEPT MASK capability, a problem occurs around a certain frequency, this may require closer examination. Stop the sweep at that point by choosing **SPOT**. You can then control the "spot" jitter frequency to make closer examination of the problem.

Setting the Interfaces

Setting Wander Transmit Interface

Setting Wander Transmit Interface

Description:
Option 200 required
for Jitter and option
012 for PDH.

You can add Wander to a 2 Mb/s or DS1 PDH signal and also to STM-0, STM-1, STM-4 or STM-16 SDH signals

TRANSMITTER OUTPUT PDH/DSn

MAIN SETTINGS STRUCT'D SETTINGS JITTER TEST FUNCTION

JITTER / WANDER WANDER
WANDER ON
SIGNAL FREQUENCY 2 Mb/s

WANDER MASK OFF

MODULATION FREQUENCY 125000 µHz
AMPLITUDE 15.0 UI

STATUS: OFF SPOT

MULTIPLE WINDOW

HOW TO:

PDH Wander (2 Mb/s)

- 1 Set up the PDH transmit interface, choose CLOCK and select the SOURCE required from the menu. If you select EXTERNAL connect the external source to the REF IN port on the CLOCK module. See "Setting PDH/DSn Transmit Interface (option 012) " page 26.
- 2 Choose JITTER/WANDER **WANDER**.
If you wish to add jitter to the PDH signal see "Setting Jitter Transmit Interface " page 34.
- 3 Choose WANDER **ON**.
- 4 Choose the WANDER MASK setting required.
You can choose the wander modulating frequency and wander amplitude if **OFF** is chosen.
If you choose **SPOT**, you can choose the "spot" wander frequency. The wander amplitude is adjusted and controlled according to your wander frequency choice.

Setting the Interfaces

Setting Wander Transmit Interface

SDH Wander (STM-0, STM-1, STM-4, STM-16)

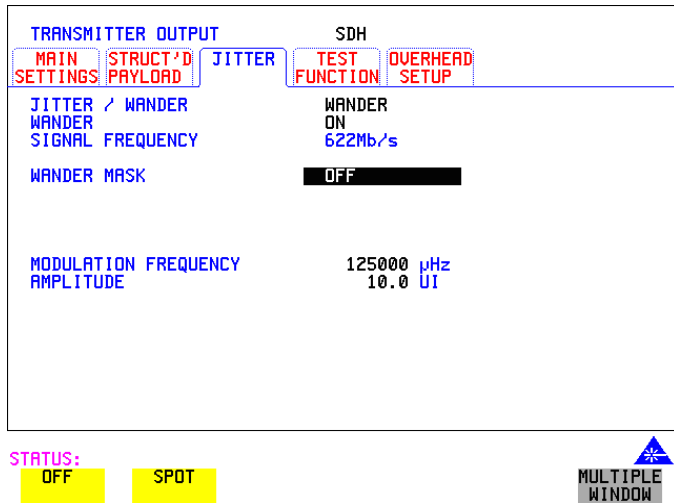

- 5 Set up the SDH transmit interface. See "Setting SDH Transmit Interface " page 29.
- 6 Choose JITTER/WANDER **WANDER**.
If you wish to add jitter to the SDH signal see "Setting Jitter Transmit Interface " page 34.
- 7 Choose WANDER **ON**.
- 8 Choose the WANDER MASK setting required.
You can choose the wander modulating frequency and wander amplitude if **OFF** is chosen.
If you choose **SPOT**, you can choose the "spot" wander frequency. The wander amplitude is adjusted and controlled according to your wander frequency choice.

Setting the Interfaces

Setting SDH THRU Mode

Setting SDH THRU Mode

Description

THRU mode is used to non-intrusively monitor SDH lines where no protected monitor points are available. To enable THRU mode select the **TRANSMIT MAIN SETTINGS** page. Select SIGNAL RATE before selecting THRU mode.

The entire frame can be errored at a user defined rate if PAYLOAD OVERWRITE and SOH+POH CHANNEL OVERWRITE are both set to **OFF**. If either overwrite is enabled the ENTIRE FRAME ERROR RATE function is disabled. Jitter can be added to the STM-0, STM-1, STM-4 and STM-16 signal.

There are nominally three modes of operation as follows:

1. Transparent mode: This is the case when the PAYLOAD OVERWRITE field is set to OFF. The received signal is passed through the transmitter completely unchanged. The figure below illustrates the settings for this mode.

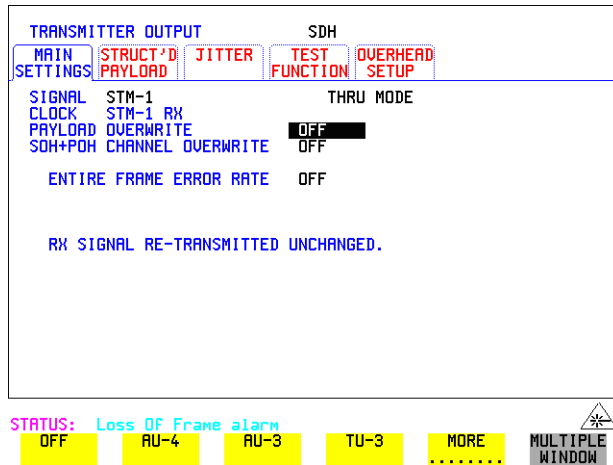

2. Hitless THRU Mode

This mode enables you to change the channel under test and the payload mapping without causing errors in the line signal or any other payload channel, or having to switch out of THRU mode. When you select a Payload Overwrite choice (other than OFF) an additional field is displayed which allows you to enable/disable Payload Overwrite. If Payload Overwrite is disabled the instrument remains transmitting while you select another channel/tributary (see figure on next page). In this mode any Section or Line B1,B2 BIP errors are recalculated before transmission.

Setting the Interfaces

Setting SDH THRU Mode

3. Payload/Channel Overwrite: In this mode you can overwrite the payload as explained in the following text. Any Path B3 BIP errors are recalculated before transmission. Use the *HOW TO* procedure to setup your instrument for THRU Mode operation.

STM-0, STM-1 and STM-0 optical, STM-1 optical

You can substitute a new payload, Section Overhead (SOH) and Path Overhead (POH) in the received STM-0/1 signal for testing.

STM-4, STM-16 and STM-4 optical, STM-16 optical

The overhead and payload may be overwritten for AU-4 and AU3. PAYLOAD OVERWRITE is not available for AU-4-4c or AU-4-16c. SOH overwrite is available for AU-4-4C and AU-4-16c.

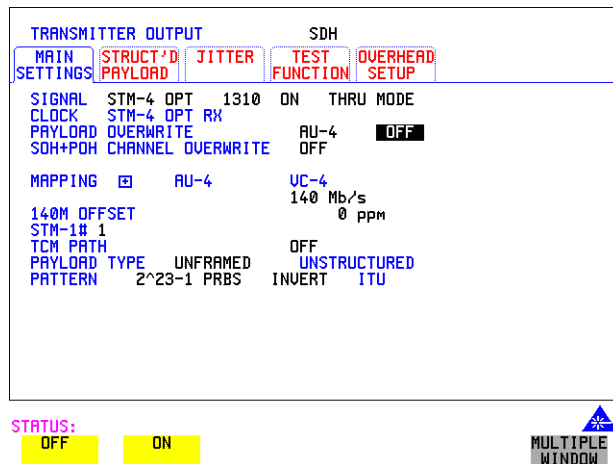

HOW TO:

- 1 Make the required SIGNAL RATE choice on the SDH **TRANSMIT** display. See "Setting SDH Transmit Interface " page 29.
- 2 Make the PAYLOAD OVERWRITE choice required
Hitless Mode: The Payload Overwrite enable/disable field (next to the PAYLOAD OVERWRITE field) defaults to OFF.

If AU-4, AU-3, TU-3, TU-2 or TU-12 is chosen, the B1, B2 and B3 BIPs are recalculated before transmission and the Mapping, Selected TU, TU Payload, Pattern, Tributary Offset and Pattern in other TU's settings are displayed. To choose the settings in these, See "Setting SDH Transmit Interface " page 29, steps 4 through 10.

Setting the Interfaces

Setting SDH THRU Mode

- 3 Switch the PAYLOAD OVERWRITE enable/disable field to ON. Test functions are available whilst Payload Overwrite is enabled. Select the **TEST FUNCTION** folder and setup as required.
- 4 Make the SOH+POH OVERWRITE choice required.
The B1, B2 and B3 BIPs are recalculated before transmission.
- 5 If you wish to add jitter to the STM-0, STM-1, STM-4 or STM-16 signal, see "Setting Jitter Transmit Interface " page 34.

Setting the Interfaces

Using Smart Test

Using Smart Test

Smart Setup

The Smartsetup feature simplifies instrument operation by:

Allowing the instrument to auto-configure on the incoming signal. It will attempt to identify signal structure and detect mixed payload signal structures and alarms.

The OmniBER 718 automatically displays all of the J1 trace identifiers. Once the received signal has been identified you can select a channel of interest and explore further into the payload.

Smart Tests

Allows you to quickly access the most commonly used instrument features such as:

- Signal quality
- Functional tests
- Jitter tests
- ATM tests
- Settings (stored, logging, Tx/Rx coupling and trigger output enable)

HOW TO USE SMARTSETUP:

- 1 Connect the OmniBER 718 to the network and choose if necessary the required SDH **RECEIVE** interface on the OmniBER 718 (Smartsetup will select PDH or SDH/SONET, but can not select between SDH and SONET).
- 2 Press **SMART TEST**.

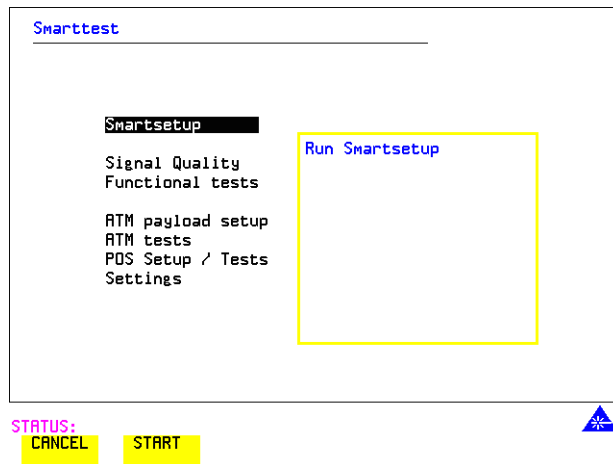

Setting the Interfaces

Using Smart Test

- 3 With Smartsetup highlighted, press **START** to auto-discover information about the receive signal. Or press **CANCEL** to exit Smart Test.

An example of a typical display after choosing to RUN Smartsetup is shown below.

Note: The channel information displayed is the one obtained the last time a SCAN was performed (see Figure 1). If you have changed the input signal since the last Smartsetup you must perform a RESCAN now. If you have selected a PDH/DSn interface and a PDH/DSn signal is received, a tributary mapping display indicating the framing and status of each tributary is given, (see Figure 2).

Figure 1

The screenshot shows a terminal window titled "Smartsetup STM16 Optical". It contains a table with three columns: "STM1#", "Payload", and "Path trace". The first row is highlighted in black and shows "1 AU4 TUG". The remaining rows show "2 AU4 Uneq" through "16 AU4 Uneq". Below the table, there are three buttons: "CANCEL", "EXPLORE FURTHER", and "RESCAN", each with a yellow background. A blue cursor arrow is positioned to the right of the buttons.

STM1#	Payload	Path trace
1	AU4 TUG	
2	AU4 Uneq	
3	AU4 Uneq	
4	AU4 Uneq	
5	AU4 Uneq	
6	AU4 Uneq	
7	AU4 Uneq	
8	AU4 Uneq	
9	AU4 Uneq	
10	AU4 Uneq	
11	AU4 Uneq	
12	AU4 Uneq	
13	AU4 Uneq	
14	AU4 Uneq	
15	AU4 Uneq	
16	AU4 Uneq	

STATUS:
CANCEL **EXPLORE FURTHER** **RESCAN**

Setting the Interfaces Using Smart Test

Figure 2

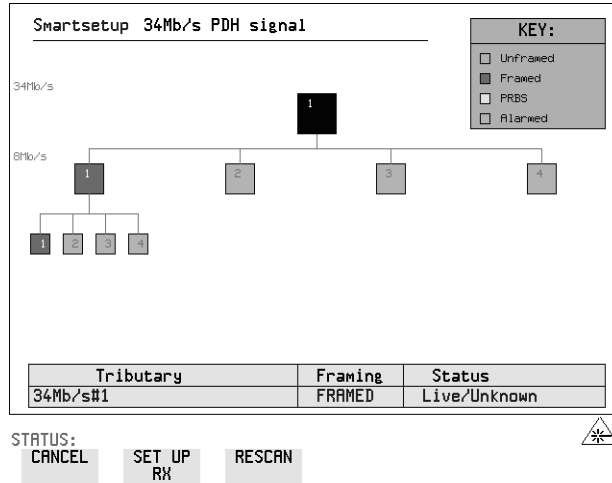

SET UP RX key

If you select an individual channel using the cursor control keys, and then select **SET UP RX**, the instrument exits Smartsetup and sets the receiver to the test pattern detected in the selected channel.

Setting the Interfaces

Using Smart Test

To run a Smart Test (Signal Quality - Frequency Measurement):

- 1 Ensure a valid signal is connected to the instrument's Receive port.
- 2 Press **SMART TEST**.
- 3 Use the down cursor control key to select Signal quality.
- 4 Use the right cursor control key to access the tests.
- 5 Use the down cursor control key to select Frequency Measurement.

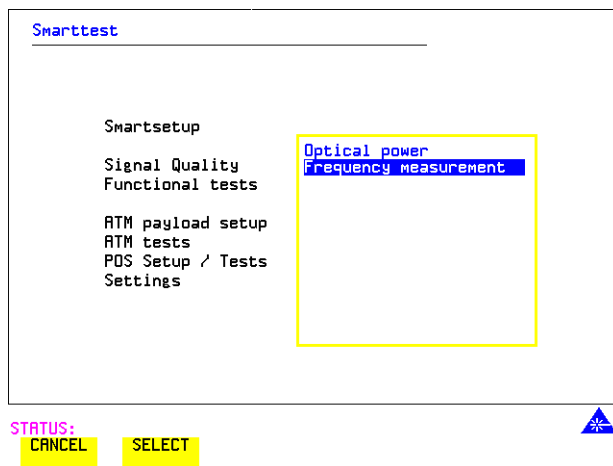

- 6 Press **SELECT** to display the frequency measurement screen. Or press **CANCEL** to exit Smart Tests.

To run an ATM Smart Test

- 1 Ensure a valid signal is connected to one of the instrument's Receive ports.
- 2 Press **SMART TEST**.
- 3 Use the down cursor control key to select ATM payload setup or ATM tests.
- 4 Use the right cursor control key to access the setups/tests.
- 5 Use the down cursor control key to select required setup/test.
- 6 Press **SELECT** to display the required measurement screen. Or press **CANCEL** to exit Smart Tests.

Setting the Interfaces Using Smart Test

7

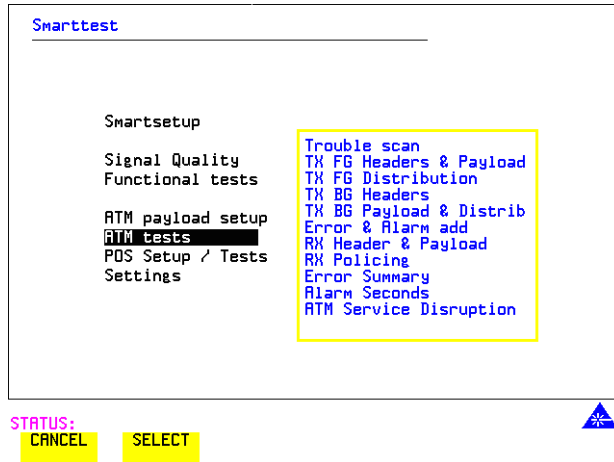
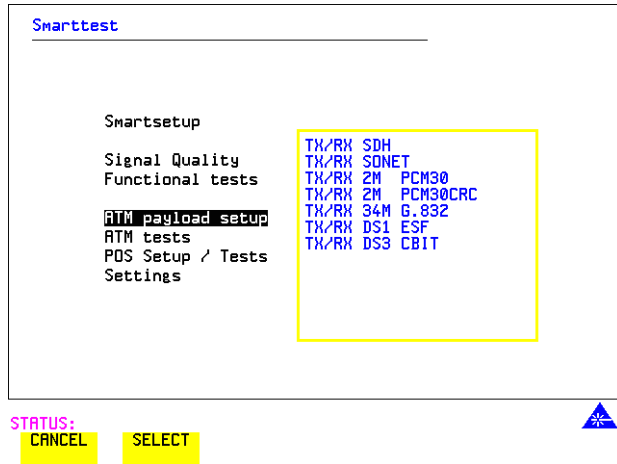

Note: It is not possible for OmniBER to find ATM in a PDH payload in Smartsetup.

Setting the Interfaces Using Smart Test

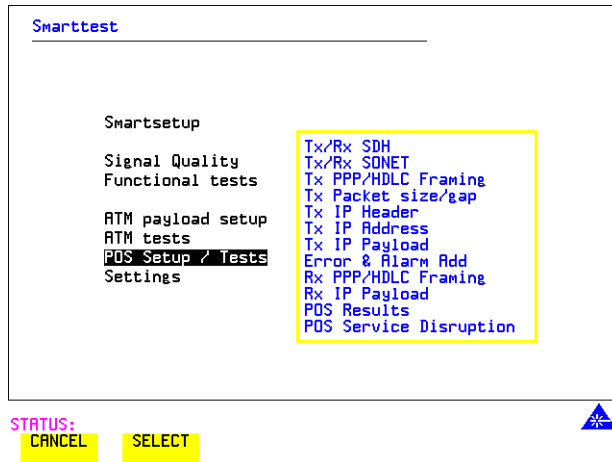

To run a POS Smart Test

- 1 Ensure a valid signal is connected to one of the instrument's Receive ports.
- 2 Press **SMART TEST**.
- 3 Use the down cursor control key to select POS Setup/Tests.
- 4 Use the right cursor control key to access the setups/tests.
- 5 Use the down cursor control key to select required setup/test.
- 6 Press **SELECT** to display the required Setup screen. Or press **CANCEL** to exit Smart Tests.

Setting PDH/DSn Receive Interface (Option 012)

Description

PDH Receive interface settings should match the network equipment settings of Rate, Termination and Line Code and determine the Payload to be tested.

TIP:

To set the transmitter and receiver to the same interface settings choose **OTHER SETTINGS CONTROL COUPLED**.

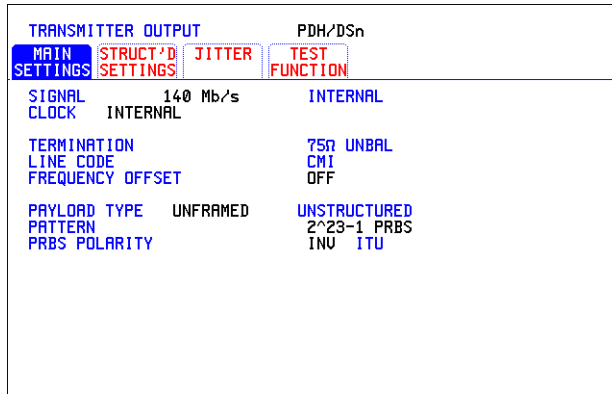

STATUS:



HOW TO:

- 1 Choose the required SIGNAL rate.
- 2 If you have chosen 2 Mb/s as the SIGNAL rate, choose the required TERMINATION. (At all other rates the impedance is fixed.)
- 3 If you have chosen 2 Mb/s, DS1 or 8 Mb/s as the SIGNAL rate, choose the required LINE CODE. (At 34Mb/s, 140 Mb/s and DS3 coding is fixed.)
- 4 If you are measuring at the network equipment monitor point, set the LEVEL field to **MONITOR**. In this case the received signal will be 20 to 30 dB below the normal level.
Choose the GAIN required to return the received signal to normal.
Choose EQUALIZATION **ON** to compensate for cable losses if required.

Setting the Interfaces

Setting PDH/DSn Receive Interface (Option 012)

Choose the PAYLOAD TYPE.

If **STRUCTURED** is required **FRAMED** must be chosen.

If **STRUCTURED** is chosen, the PDH test signal must be set up. See “Setting Transmit Structured Payload/Test Signal” page 70.

If you chose 2 Mb/s, DS1 or DS3 as the PDH/DSn SIGNAL rate, the FRAMED choice is expanded to provide a menu of framing types.

- 5 Choose the PATTERN type and the PRBS POLARITY required.

Additional Patterns at DS1

- 6 If you select a DS1 SIGNAL, two 8-bit patterns and a 55 Octet pattern are added to the list of available patterns. They are as follows:

Table 3 **8-Bit Patterns**

Type	Pattern
1-in-8	F01000000
2-in-8	F01100000

Note 1: F indicates the position of the framing bit with respect to the 8-bit pattern when the framed data is generated

Note 2: Both 8-bit patterns and the 55 Octet pattern can only be selected as a payload for the whole DS1, i.e. they can not be selected as a pattern for an individual 64 kb/s channel.

The 55 Octet pattern uses the Daly pattern as per ANSI T1.403.

Setting the Interfaces

Setting SDH Receive Interface

Setting SDH Receive Interface

Description

SDH Receive interface settings should match the network equipment settings of Rate and Mapping, and determine the payload to be tested.

TIP:

If you wish to set the OmniBER 718 transmitter and receiver to the same interface settings, choose **OTHER** **SETTINGS CONTROL** **COUPLED**. This causes the receiver to be configured to the same settings as the transmitter.

RECEIVER INPUT		SDH		
MAIN SETTINGS	STRUCT'D PAYLOAD	JITTER	TEST FUNCTION	OVERHEAD MONITOR
SIGNAL LEVEL		STM-1 TERMINATE		
MAPPING	AU-4	TU-12 ASYNC 2Mb/s		
TCM PATH	TUG3# 1	TUG2# 6	TU# 3	
TU PAYLOAD	PCM30CRC	OFF		
PATTERN	2^11-1 PRBS	INUERT	NON-ITU	

STATUS:

MULTIPLE WINDOW

HOW TO:

- 1 Choose the required SIGNAL source either electrical or optical.
If STM-0 or STM-1 electrical is chosen, choose the required LEVEL.
If the LEVEL chosen is **MONITOR** choose the required GAIN.
- 2 Choose mapping and type of payload.
- 3 If TU-2 mapping is chosen, and CONCATENATION is enabled, choose the tributary at which the concatenation begins.
If TU-2, TU-3, TU-12 or TU11 mapping is chosen, choose the test tributary, including the STM-1 for an STM-4/STM-16 signal.
- 4 Choose the payload framing under PAYLOAD TYPE or TU PAYLOAD.
If **STRUCTURED** is required **FRAMED** must be chosen.
If **STRUCTURED** is chosen the Payload test signal must be set up. See “Setting Receive Structured Payload/Test Signal” page 72.
If DROP is chosen, see “Dropping an External Payload/Test Signal” page 79.
- 5 Choose the PATTERN type and PRBS polarity.

Setting the Interfaces

Setting Jitter Receive Interface

Setting Jitter Receive Interface

Description:
Option 200 required for Jitter.

Jitter and error measurements are made simultaneously when a jitter option is fitted. Jitter measurement up to 2.5 Gb/s is also available when ATM is selected as a payload.

The jitter receive interface is selected with **RECEIVE PDH/DSn JITTER** or **RECEIVE SDH JITTER** MEASUREMENT TYPE **JITTER**.

The choices made on the jitter receive interface determine the jitter measurement range, the threshold level for determining a jitter hit and which filters are used in the jitter measurement.

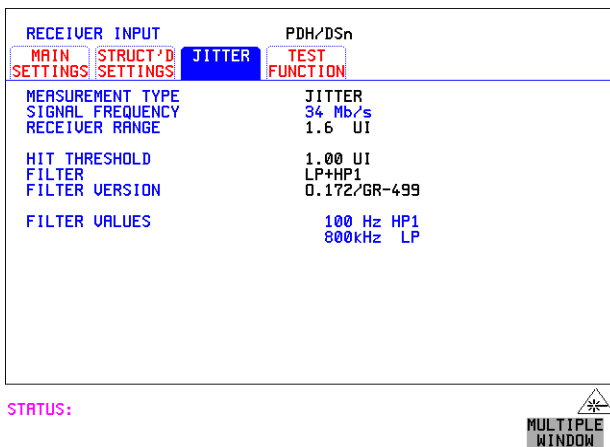

HOW TO:

- 1 Choose the RECEIVER RANGE - the jitter measurement range.
- 2 Choose the HIT THRESHOLD level - if the received jitter exceeds the value chosen a jitter hit is recorded.
- 3 Choose the FILTER you wish to include in the peak to peak and RMS jitter measurement. The choices are:
OFF, LP, HP1, HP2, 12kHz HP, LP+HP1, LP+HP2, LP+12kHz HP
- 4 If you have selected a PDH/DSn Receive Interface you can also select FILTER VERSION, O.171 or O.172/GR-499. The selection is not available with an SDH Receive Interface.

Setting the Interfaces

Setting Extended Jitter Receive Interface

Setting Extended Jitter Receive Interface

Description:
Option 200 required for Jitter.

These measurements are made at the upper end of the standard wander frequency range and the lower end of the standard jitter frequency range. The extended jitter receive interface is selected with **RECEIVE PDH/DSn JITTER** or **RECEIVE SDH JITTER** MEASUREMENT TYPE **EXTENDED**.

The choices made on the jitter receive interface determine the threshold level for determining a jitter hit. The measurement Range and the Filters are not selectable.

RECEIVER INPUT		SDH		
MAIN SETTINGS	STRUCT'D PAYLOAD	JITTER	TEST FUNCTION	OVERHEAD MONITOR
MEASUREMENT TYPE		EXTENDED		
SIGNAL FREQUENCY		2.5Gb/s OPT		
RECEIVER RANGE		1024 UI		
JITTER BANDWIDTH	0.1 Hz - 25 kHz			
HIT THRESHOLD		10 UI		
FILTER		FIXED		

STATUS:

MULTIPLE WINDOW

HOW TO:

- 1 Choose MEASUREMENT TYPE **EXTENDED**.
- 2 Choose the HIT THRESHOLD level - if the received jitter exceeds the value chosen a jitter hit is recorded.

Setting the Interfaces

Setting Wander Receive Interface

Setting Wander Receive Interface

Description:

You can measure Wander at all PDH and SDH rates. Select an external clock source on the **TRANSMIT** **PDH/DSn** or **SDH** **MAIN SETTINGS** display to ensure accurate Wander results.

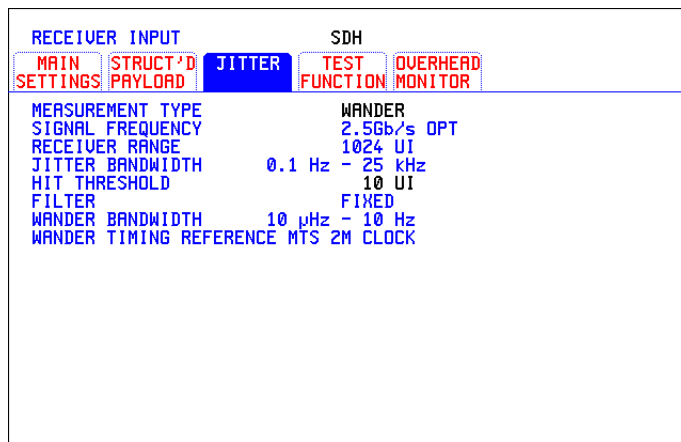

STATUS:

MULTIPLE
WINDOW

HOW TO:

- 1 Choose a synchronization clock source on the **TRANSMIT** **SDH** or **PDH/DSn** **MAIN SETTINGS** display. See, “Setting SDH Transmit Interface” page 29.
- 2 If you intend to measure wander on a PDH signal, set up the PDH receive interface. See, “Setting PDH/DSn Receive Interface (Option 012)” page 47.
- 3 If you intend to measure wander on a SDH signal, set up the SDH receive interface. See, “Setting SDH Receive Interface” page 49.
- 4 Choose MEASUREMENT TYPE **WANDER**.
- 5 Choose the wander HIT THRESHOLD - if the received wander exceeds the value chosen a wander hit is recorded.

“Using Transmit Overhead Setup”	page 54
“Using Receive Overhead Monitor”	page 56
“Setting Overhead Trace Messages”	page 58
“Setting Overhead Labels”	page 59
“Generating Overhead Sequences”	page 60
“Using Receive Overhead Capture”	page 62
“Adding Frequency Offset to SDH Signal”	page 64
“Adding Frequency Offset to the PDH/DSn Signal”	page 66
“Setting up Signaling Bits”	page 67
“Setting Transmit Structured Payload/Test Signal”	page 70
“Setting Receive Structured Payload/Test Signal”	page 72
“Setting Transmit N x 64 kb/s/N x 56 kb/s Structured Payload/Test Signal”	page 73
“Setting Receive N x 64 kb/s/N x 56 kb/s Structured Payload/Test Signal”	page 75
“Inserting an External PDH/DSn Payload/Test Signal”	page 76
“Dropping an External Payload/Test Signal”	page 79
“Adding Errors & Alarms at the SDH Interface”	page 82
“Adding Pointer Adjustments”	page 87
“Using Pointer Graph Test Function”	page 95
“Stressing Optical Clock Recovery Circuits”	page 97
“Generating Automatic Protection Switch (APS) Messages”	page 99
“Generating Automatic Protection Switch (APS) Messages”	page 99
“Inserting and Dropping the Data Communications Channel”	page 104
“Using DS1 LOOP Codes”	page 105

Selecting Test Features

Selecting Test Features

Using Transmit Overhead Setup

Using Transmit Overhead Setup

Description

You can set an overhead byte to a known static state to aid troubleshooting, for example to quickly check for "stuck bits" in path overhead bytes. Section Overhead, Path Overhead, Trace Messages and Labels can be set using this feature.

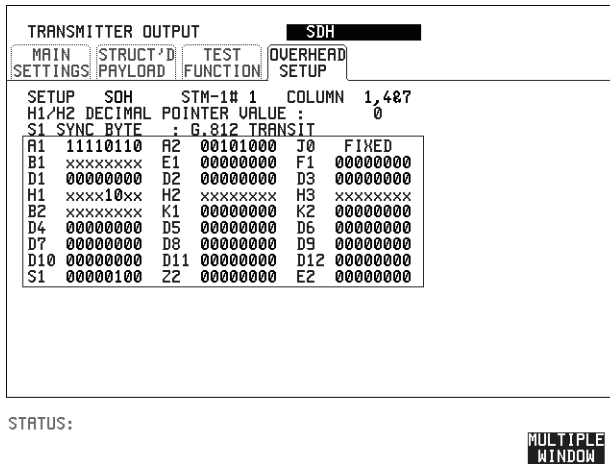



HOW TO:

- 1 Set up the SDH transmit interface and payload required. See "Setting SDH Transmit Interface " page 29.
- 2 Choose the type of overhead to SETUP.
If STM-4 OPT or STM-16 OPT is chosen as the SDH interface, choose the STM-1 you wish to set up.
DEFAULT - Use to set all overhead bytes to the standard values defined by Bellcore/ANSI.
If a test function is active then the overhead byte value is determined by the choices made in the Test Function. For example if APS Messages is chosen, the K1K2 value is determined by the APS Messages setup.
- 3 If SOH (Section Overhead) is chosen, choose the COLUMN to be displayed.
Many bytes in COLS 2,5,8 and 3,6,9 are unlabeled as the other overhead functions have not yet been defined.
If ALL COLUMNS is chosen, the hexadecimal value of all 81 bytes of the STM-1 section overhead selected are displayed (all 324 bytes of an STM-4 or 1,296 bytes of an STM-16 are displayed 81 bytes at a time by selecting each STM-1 in

Selecting Test Features

Using Transmit Overhead Setup

turn). The value of the bytes can be set using **DECREASE DIGIT** **INCREASE DIGIT**  .

If BYTE NAMES is chosen, the labels for the ALL COLUMNS overhead bytes are displayed.

- 4 If POH (Path Overhead) is chosen, choose the TYPE of overhead within STM-1 under test to be setup.
J1 and J2 bytes can be set under Path Overhead or Trace Messages. H4 byte has a choice of sequences for TU-12, TU11 and TU-2 mapping:
Full Sequence - 48 byte binary sequence.
Reduced Sequence - Binary count sequence of 0 to 3 i.e. 111111(00 to 11).
COC1 Sequence - Binary count sequence of 0 to 3 i.e. 110000(00 to 11).
- 5 If TRACE MESSAGES is chosen, see "Setting Overhead Trace Messages " page 58.

NOTE

Any bit of an overhead byte which is displayed as x or s cannot be set at any time. All other bits can be set to 0 or 1.

TIP:

You can set all overhead bytes to the default state by selecting SETUP **DEFAULT**.

You can set all overhead bytes and test functions to the default state by recalling Stored Settings [0] on the **OTHER** display.

Using Receive Overhead Monitor

Description

When first connecting to a SDH network, a start up confidence check can be made by viewing the behavior of all the overhead bytes. If the SDH network shows alarm indications, some diagnosis of the problem may be gained from viewing all the overhead bytes. The OVERHEAD MONITOR display is updated once per second (once per 8000 frames) approximately.

A snapshot of the received overhead can be logged to the chosen logging device. See "Logging on Demand " page 261.

RECEIVER INPUT				SDH				
MAIN	STRUCT'D	TEST	OVERHEAD					
SETTINGS	PAYLOAD	FUNCTION	MONITOR					
MONITOR				SDH	STM-1#	1	COLUMN	1,4&7
S1 SYNC STATUS :				G.812 TRANSIT				
A1	11110110	A2	00101000	J0	00000001			
B1	10110010	E1	00000000	F1	00000000			
D1	00000000	D2	00000000	D3	00000000			
H1	01101000	H2	00000000	H3	00000000			
B2	01110111	K1	00100001	K2	10101101			
D4	00000000	D5	00000000	D6	00000000			
D7	00000000	D8	00000000	D9	00000000			
D10	00000000	D11	00000000	D12	00000000			
S1	00000100	Z2	00000000	E2	00000000			

STATUS:

MULTIPLE WINDOW

HOW TO:

- 1 Set up the receive SDH interface and payload as required. See "Setting SDH Receive Interface" page 49.
- 2 Choose the type of overhead to MONITOR.
- 3 If SOH (Section Overhead) is chosen, choose the STM-1 number and COLUMN to be displayed.
 Many bytes in COLS 2,5,8 and 3,6,9 are unlabeled because the other overhead functions have not yet been defined.
 If ALL COLUMNS is chosen, the hexadecimal value of all 81 bytes of section overhead is displayed (all 324 bytes of an STM-4 or 1,296 bytes of an STM-16 are displayed 81 bytes at a time by selecting each STM-1 in turn). The value of the bytes can be set using **DECREASE DIGIT** **INCREASE DIGIT** **←** **→**.

Selecting Test Features

Using Receive Overhead Monitor

If BYTE NAMES is chosen, the labels for the ALL COLUMNS overhead bytes are displayed.

- 4 If POH (Path Overhead) is chosen, choose the source of the overhead VC-4, VC-3, VC-2, VC-12 or VC-11.
J1 and J2 bytes can be monitored under Path Overhead or Trace Messages
- 5 If TRACE MESSAGES is chosen, you can monitor a data message to verify portions of the network.
If the 16 byte CRC7 message structure is detected, the 15 characters within the message are displayed.
If the CRC7 structure is not detected in J1, the 64 byte message format is assumed and displayed.
If the CRC7 structure is not detected for J0 or J2, all 16 bytes are displayed.
- 6 If LABELS is chosen, the S1 sync status, HP path label (C2) and the LP Path label (V5) are monitored.
- 7 If APS MESSAGES is chosen, choose the TOPOLOGY, **LINEAR** (G.783) or **RING** (G.841). The K1 and K2 bits are monitored.

TIP:

If any abnormal behavior is observed on a particular path or section overhead byte, or an associated group of bytes (3XA1,3XA2; D1 - D3), the **RECEIVE TEST FUNCTION** display of **OVERHEAD CAPTURE** can be used to "Zoom" in on the suspect byte or bytes on a frame by frame basis. See "Using Receive Overhead Capture " page 62.

Selecting Test Features

Setting Overhead Trace Messages

Setting Overhead Trace Messages

Description

You can insert a data message to verify portions of the network:

J0 verifies the regenerator section overhead.

J1 verifies the VC-3 or VC-4 path connection.



J2 verifies the VC-2, VC-12 or VC-11 path connection.

The screenshot shows a terminal window titled "TRANSMITTER OUTPUT" with a cursor at the end of the line "[SDH]". Below the title is a menu with five options: "MAIN SETTINGS", "STRUCT'D PAYLOAD", "JITTER", "TEST FUNCTION", and "OVERHEAD SETUP". The "TRACE" option is highlighted. Below the menu, the text "SETUP [TRACE]" and "WITHIN STM-1# 1" is displayed. Three trace message options are listed: "J0 [FIXED]" with a value of "[00000001]", "J1 [TEST 64] (UC-4)" with a value of "\"HEWLETT-PACKARD, ??NAME?? OMNIBER GB0000000, D.00.00\"", and "J2 [DEFAULT] (UC-12)" with a value of "\"BBBBBBBBBBBBBBBB\"". At the bottom of the screen, a row of five buttons is visible: "SOH", "POH", "TRACE MESSAGES", "LABELS", and "DEFAULT".

Choose the message for insertion in the chosen trace channel.

How to Edit User Messages

There are two ways you can edit a user message as follows;

- Use the edit keys at the bottom of the display JUMP, PREVIOUS CHAR, NEXT CHAR  and  that are displayed when you position the cursor on a User message or:
- Use the POP UP alphanumeric keypad that is displayed when you press the front panel **SET** key. Detailed instructions on how to change instrument settings using the POP UP keypad is given in the Quick Start Guide (page 13) under the heading “Changing Instrument Settings”.

Selecting Test Features

Setting Overhead Labels

Setting Overhead Labels

Description

Choosing LABELS allows the setting of the S1 SYNC STATUS, HP PATH LABEL (C2) and LP PATH LABEL (V5).

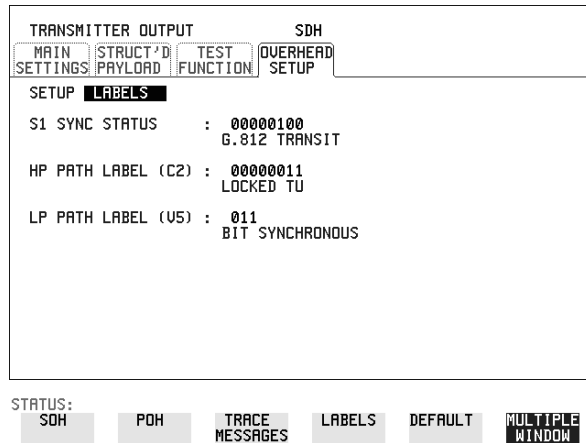

How to Edit User Defined Labels

- 1 Choose the overhead label that you want to edit.
- 2 Edit the label using the softkeys at the bottom of the display. If you select USER, use the softkeys at the bottom of the display to edit the label key, or press **SET**, then use the softkeys and pop-up keypad to edit the label. Detailed instructions on how to change instrument settings using the pop-up keypad is given in the Quick Start Guide (page 13) under the heading “Changing Instrument Settings”.

Selecting Test Features

Generating Overhead Sequences

Generating Overhead Sequences

Description

You may insert a sequence of patterns into a functional group of overhead bytes for testing or troubleshooting purposes.

TRANSMITTER OUTPUT		SDH	
MAIN	STRUCT'D	TEST	OVERHEAD
SETTINGS	PAYLOAD	FUNCTION	SETUP
TEST FUNCTION	SDH	SEQUENCES	
REPEAT RUN	STOPPED	-SEQUENCE STOPPED	
RSOH	3xA1, 3xA2	STM-1# 1	
A	F6F6F6282828		
B	B9C8F8FC8CD2		
C	36FC16282828		
D	76F6F6A82828		
E	BA3827393939		
SEQUENCE	64000	FRAMES OF	A THEN
	91		B
	0		C
	0		D
	0		E

STATUS:

MULTIPLE
WINDOW

HOW TO:

- 1 Set up the SDH transmit interface and payload required. See “Setting SDH Transmit Interface” page 29.
- 2 Select **TEST FUNCTION** , SDH, SEQUENCES as shown above.
- 3 Choose the type of sequence required.
SINGLE RUN - runs the sequence once and then stops.
REPEAT RUN - runs the sequence repeatedly until STOPPED is chosen.
- 4 Choose the overhead type as required.
RSOH- Regenerator Section Overhead
MSOH- Multiplexer Section Overhead
POH - Path Overhead
- 5 Choose the byte or bytes of overhead required.
- 6 Set up the required number of data patterns and the number of frames in which each data pattern should appear.
Your sequence is derived from up to 5 blocks of hexadecimal data. Each block can be transmitted in up to 64,000 frames.
The data and the number of frames are set using **DECREASE DIGIT** **INCREASE DIGIT** **←** **→**.

Selecting Test Features

Generating Overhead Sequences

7 Start the sequence by choosing **START**.

NOTE

When you start the sequence illustrated, one Out of Frame alarm and one Loss of Frame alarm should occur every eight seconds.

A1A2 Boundary Function

A1A2 provide a frame alignment pattern (A1=F6 H, A2=28 H). Use A1A2 to test the 6 framing bytes at the A1A2 boundary in the section overhead (see display on previous page). The 6 bytes across the boundary are:

STM-n

STM-1 channel:	#n-2	#n-1	#n	#1	#2	#3
Overhead byte:	A1 #3	A1 #3	A1 #3	A2 #1	A2 #1	A2 #1

A network element, typically only uses three of these bytes (which ones are not defined in the standards, so will vary between manufacturers) to gain and maintain frame synchronization. In many cases the A1A2 bytes selected are those at the A1A2 boundary (i.e. the A1 bytes in the last STM-1 channel and the A2 bytes in the first STM-1 channel). Therefore, the ability to stress test across the boundary is necessary to verify a correct synchronization algorithm within a network element.

A network element will use three of these bytes (which ones are not defined in the standards, so will vary between manufacturers) to gain and maintain frame synchronization. The ability to stress test across the boundary is necessary to verify a correct synchronization algorithm within a network element.

Selecting Test Features

Using Receive Overhead Capture

Using Receive Overhead Capture

Description

Regenerator section, Multiplexer section and Path overhead provide network support functions, responding dynamically to network conditions and needs. It is therefore useful to capture overhead activity on a frame by frame basis.

The Overhead Capture display can be logged to the chosen logging device. See "Logging on Demand " page 261.

RECEIVER INPUT		SDH	
MAIN SETTINGS	STRUCT'D PAYLOAD	TEST FUNCTION	OVERHEAD MONITOR
TEST FUNCTION	SDH	O/H CAPTURE	
RSOH	3xR1, 3xR2	STM-1#	1
TRIGGER	ON	F6F6F6282828	
CAPTURE	STOPPED		
DATA		FRAME COUNT	
F6F6F6282828		48048	
090909D7D7D7		3040	
F6F6F6282828		64000	
F6F6F6282828		64000	
F6F6F6282828		64000	
F6F6F6282828		64000	
F6F6F6282828		64000	
F6F6F6282828		13636	
090909D7D7D7		1	

STATUS:

MULTIPLE WINDOW

HOW TO:

- 1 Set up the receive SDH interface and payload as required. See "Setting SDH Receive Interface" page 49.
- 2 Select **TEST FUNCTION**, SDH, O/H CAPTURE as shown above
- 3 Choose the overhead type as required.
RSOH- Regenerator Section Overhead
MSOH- Multiplexer Section Overhead
POH- Path Overhead
- 4 Choose the Byte or bytes of overhead to be captured.

Choose the TRIGGER to determine the start point of the capture.

OFF - starts immediately the capture is initiated. Can be used to provide a frame by frame monitor of the chosen byte or bytes.

ON -captures activity after your specified overhead state has occurred. Can be used for transient detection from a specified expected state.

Selecting Test Features

Using Receive Overhead Capture

ON NOT - captures activity after the first occurrence of a deviation from your specified overhead state. Can be used for transient detection from a specified expected state.

- 5 Up to 16 records of overhead state are provided. Each record will represent between 1 and 64,000 frames. A capture is started by pressing CAPTURE **START** and terminates when up to 16 records have been captured. The capture can be terminated earlier by pressing CAPTURE **STOP**.

Adding Frequency Offset to SDH Signal

Description

Frequency offset can be added to the SDH interface rate signal and to the payload signal.

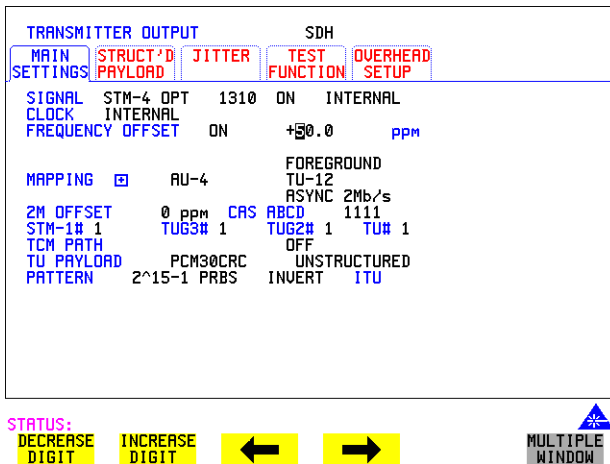

HOW TO:

Line Rate Offset



- 1 Choose the amount of frequency offset required.
 You can set the Frequency Offset in the range -999 ppm to +999 ppm in 1 ppm steps using **DECREASE DIGIT** **INCREASE DIGIT** and or press **SET** for a pop-up numerical keypad.
 The amount of applied Frequency Offset can be varied while measurements are taking place.
 If the value of the SDH line rate offset chosen is sufficient to cause the maximum stuff rate to be exceeded, the asynchronous payload is offset to prevent bit errors occurring and the maximum stuff rate is maintained. When Floating Byte 2 Mb/s is chosen, in conjunction with SDH line rate offset, the chosen tributary will be offset as the line rate is offset. (No pointer movements).

Selecting Test Features

Adding Frequency Offset to SDH Signal

Tributary Offset ± 100 ppm

- 1 Choose the amount of tributary offset required.

You can set the Offset in the range -100 ppm to +100 ppm in 1 ppm steps using **DECREASE DIGIT** **INCREASE DIGIT**  and  or press **SET** for a pop-up numerical keypad.

The amount of applied Frequency Offset can be varied while measurements are taking place.

Tributary offset affects the stuff rate but does not cause pointer movements and can be used to test mapping jitter. If the combined value of SDH line rate offset and tributary offset chosen is sufficient to cause the maximum stuff rate to be exceeded the payload is offset to prevent bit errors occurring and the maximum stuff rate is maintained.

Adding Frequency Offset to the PDH/DSn Signal

Description



Option 012 required for PDH operation.

You can add frequency offset to the interface PDH/DSn SIGNAL at all rates. Frequency Offset can be added at preset ITU-T values or as User defined values in the range ± 100 ppm. The preset values change with the SIGNAL rate chosen as shown:

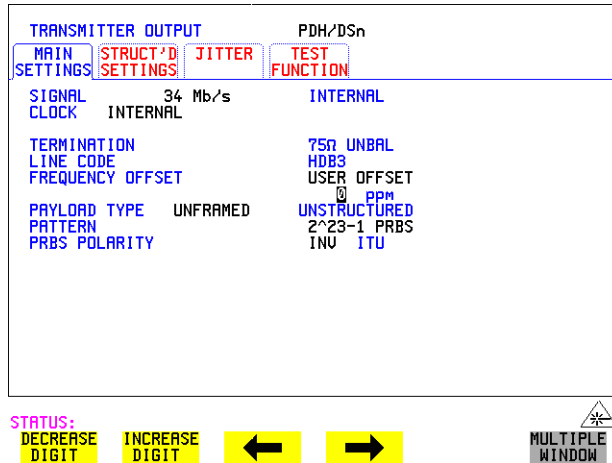
DS-1 (1.544 Mb/s)	+32 ppm	-32 ppm
2 Mb/s (E1)	+50 ppm	-50 ppm
8 Mb/s (E2)	+30 ppm	-30 ppm
34 Mb/s (E3)	+20 ppm	-20 ppm
DS-3 (44.736 Mb/s)	+20 ppm	-20 ppm
140 Mb/s (E4)	+15 ppm	-15 ppm



HOW TO:

- 1 Choose the FREQUENCY OFFSET required.
- 2 If you choose USER OFFSET, you can set the frequency offset to be between -100 ppm and +100 ppm in 1 ppm steps. Select the field immediately below USER OFFSET and use **DECREASE DIGIT**, **INCREASE DIGIT**,  and  to set the frequency offset. (The amount of frequency offset can be varied while measurements are taking place.)

Selecting Test Features

Setting up Signaling Bits

Setting up Signaling Bits

Description
Option 012 required for PDH operation.

When transmitting 2.048 Mb/s signals with timeslot-16 CAS (PCM30 or PCM30CRC) multiframing the state of A,B,C,D signaling bits can be set. The signaling bits of all timeslots are set to the user-defined 4-bit value.

When transmitting a DS1 framed, structured signal the values of the A,B signaling bits for D4 and SLC-96 payloads, and A,B,C,D signaling bits for ESF payloads can be defined.

HOW TO

Transmit a 2 Mb/s signal with user-defined signaling bits PDH Operation

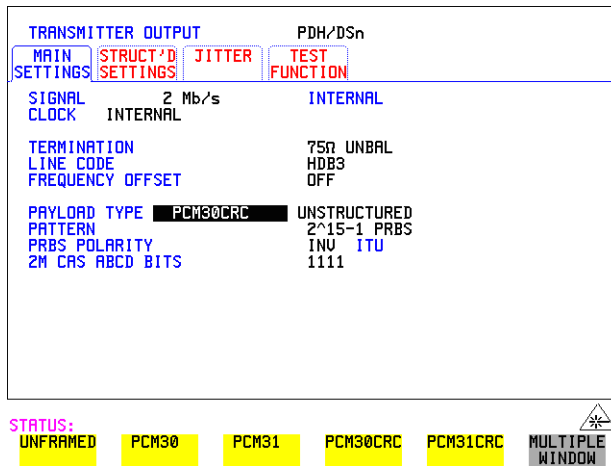

- 1 Choose **PDH/DSn** on the **TRANSMIT** display.
- 2 Choose SIGNAL **2 Mb/s** and PAYLOAD TYPE **PCM30** or **PCM30CRC** on the **MAIN SETTINGS** display.
- 3 If UNSTRUCTURED is chosen set the 2M CAS ABCD bits value on the **MAIN SETTINGS** display.
If STRUCTURED is chosen set the 2M CAS ABCD bits value on the **STRUCTURED SETTINGS** display.

Selecting Test Features

Setting up Signaling Bits

SDH Operation

TRANSMITTER OUTPUT		SDH	
MAIN SETTINGS	STRUCT'D PAYLOAD	JITTER	TEST FUNCTION
OVERHEAD SETUP			
SIGNAL	STM-4 OPT	1310	ON
CLOCK	INTERNAL		INTERNAL
FREQUENCY OFFSET	OFF		
MAPPING	<input checked="" type="checkbox"/> AU-4		BACKGROUND
			TU-12
			FL BYTE 2Mb/s
2M CAS ABCD BITS			1111
STM-1# 1	TUG3# 1	TUG2# 1	TU# 1
TCM PATH			OFF
TU PAYLOAD	PCM30		UNSTRUCTURED
PATTERN	2 ¹⁵ -1 PRBS	INVERT	ITU

STATUS:

PCM30	PCM31	PCM30CRC	PCM31CRC	INSERT 2Mb/s	MULTIPLE WINDOW
-------	-------	----------	----------	--------------	-----------------

- 1 Choose **SDH** on the **TRANSMIT** display.
- 2 Set MAPPING to TU-12.
- 3 Choose MAPPING **ASYNC 2Mb/s** or **FL BYTE 2Mb/s** and TU PAYLOAD to **PCM30** or **PCM30CRC** on the **MAIN SETTINGS** display.
- 4 If UNSTRUCTURED is chosen set the 2M CAS ABCD bits value on the **MAIN SETTINGS** display.
If STRUCTURED is chosen set the 2M CAS ABCD bits value on the **STRUCTURED SETTINGS** display.

Selecting Test Features

Setting up Signaling Bits

HOW TO

Transmit a DS1 payload signal with user-defined signaling bits

PDH Operation

TRANSMITTER OUTPUT		PDH/DSn
MAIN SETTINGS	STRUCT'D SETTINGS	TEST FUNCTION
TEST SIGNAL		56 kb/s
DS1 PAYLOAD		ESF
	DS2	DS1 56kb
	1	1 1
PATTERN		2 ¹¹ -1 PRBS
PRBS POLARITY		NDRM
B/G PATTERN		RIS
B/G PATTERN 56 kb/s		NUMBERED
DS1 ESF ABCD BITS		1111

STATUS: D4 ESF SLC-96 MULTIPLE WINDOW

- 1 Choose **PDH/DSn** on the **TRANSMIT** display.
- 2 Choose SIGNAL **DS1** or **DS3**, and PAYLOAD TYPE **STRUCTURED** on the **MAIN SETTINGS** display
- 3 Choose TEST SIGNAL **56 kb/s** or **Nx56 kb/s** on the **STRUCTURED SETTINGS** display.
- 4 Set the A,B bits (for D4 and SLC-96) and A,B,C,D bits (for ESF) as required.

SDH Operation

- 1 Choose **SDH** on the **TRANSMIT** display.
- 2 Set MAPPING to TU-12.
- 3 Choose MAPPING **FL BYTE DS1**, **ASYNC DS1** or **DS3** and TU PAYLOAD **STRUCTURED** on the **MAIN SETTINGS** display. If you choose **FL BYTE DS1** proceed to step 5.
- 4 Choose TEST SIGNAL **56 kb/s** or **Nx56 kb/s** on the **STRUCTURED SETTINGS** display .
- 5 Set the A,B bits (for D4 and SLC-96) and A,B,C,D bits (for ESF) as required.
- 6 **Floating Byte DS1 selection:** Set the ABCD bits for **NO-F-BIT** or **ESF** framing and/or the AB bits for **D4** TU PAYLOAD framing as required.

Selecting Test Features
Setting Transmit Structured Payload/Test Signal

Setting Transmit Structured Payload/Test Signal

Description

Structured PDH Payload/Test Signal settings determine the SDH payload or the PDH test signal to be tested and set any background (non test) conditions to prevent alarms while testing.

TIP:

If you wish to set the OmniBER 718 transmitter and receiver to the same Payload settings, choose **OTHER SETTINGS CONTROL COUPLED**.

TRANSMITTER OUTPUT		SDH	
MAIN SETTINGS	STRUCT'D PAYLOAD	TEST FUNCTION	OVERHEAD SETUP
TEST SIGNAL			64 kb/s
2M PAYLOAD			PCM30
	34Mb	8Mb	2Mb
	3	4	2
			64kb
			22
PATTERN		2^11-1 PRBS	
PRBS POLARITY		NORM ITU	
B/G PATTERN		RIS	
B/G PATTERN 64 kb/s		NUMBERED	
2M CAS ABCD BITS		1111	

STATUS:

MULTIPLE WINDOW

HOW TO:

- 1 Choose the required TEST SIGNAL rate. If Nx64 kb/s is chosen, see "Setting Transmit N x 64 kb/s/N x 56 kb/s Structured Payload/Test Signal " page 73.
- 2 Choose the PAYLOAD framing pattern.
 If the TEST SIGNAL chosen was 2Mb/s, the **INSERT 2 Mb/s** choice is added to PAYLOAD menu. See "Inserting an External PDH/DSn Payload/Test Signal " page 76.
- 3 Choose the test tributary in the structured payload, under 34Mb, 8Mb, 2Mb, 64 kb/s or DS2, DS1.
- 4 Choose the PATTERN type and PRBS POLARITY.

Selecting Test Features

Setting Transmit Structured Payload/Test Signal

- 5** Choose the B/G PATTERN (Background).
The B/G PATTERN in the non test 64 kb/s timeslots is fixed as NUMBERED, that is, each timeslot contains a unique number to allow identification in case of routing problems.

Signaling

- 6** If a 2 Mb/s PAYLOAD with PCM30 or PCM30CRC framing, or 56 kb/s or Nx56kb/s Test Signal is chosen. See, "Setting up Signaling Bits " page 67.

Selecting Test Features

Setting Receive Structured Payload/Test Signal

Setting Receive Structured Payload/Test Signal

Description

Structured PDH Payload/Test Signal settings determine the SDH payload or the PDH test signal to be tested.

TIP:

If you wish to set the OmniBER 718 transmitter and receiver to the same Payload settings, choose **OTHER SETTINGS CONTROL COUPLED**

RECEIVER INPUT		SDH	
MAIN SETTINGS	STRUCT'D PAYLOAD	TEST FUNCTION	OVERHEAD MONITOR
TEST SIGNAL			64 kb/s
2M PAYLOAD			PCM30
	34Mb	8Mb	2Mb
	3	4	2
			64kb
			22
PATTERN			2 ¹¹ -1 PRBS
PRBS POLARITY			NORM ITU

STATUS:

MULTIPLE WINDOW

HOW TO:

- 1 Choose the required Test Signal rate. If N x 64 kb/s or N x 56 kb/s is chosen, see "Setting Receive N x 64 kb/s/N x 56 kb/s Structured Payload/Test Signal " page 75.
- 2 Choose the Framing pattern of the PAYLOAD.
If 2 Mb/s TEST SIGNAL is chosen, **DROP 2 Mb/s** is added to the menu.
See "Dropping an External Payload/Test Signal " page 79.
- 3 Choose the test tributary within the structured payload, under 34Mb, 8Mb, 2Mb, 64 kb or DS2, DS1.
- 4 Choose the PATTERN type and PRBS polarity.

Setting Transmit N x 64 kb/s/N x 56 kb/s Structured Payload/Test Signal

Description

Wideband services such as high speed data links and LAN interconnection require a bandwidth greater than 56/64 kb/s but less than DS1/2 Mb/s for example 128 kb/s or 384 kb/s. These wideband signals are sent in a DS1/2 Mb/s frame by sharing the signal across multiple timeslots.

N x 64kb/s/N x 56 kb/s structured payload allows a test pattern to be inserted across a number of timeslots even if the chosen timeslots are non-contiguous.

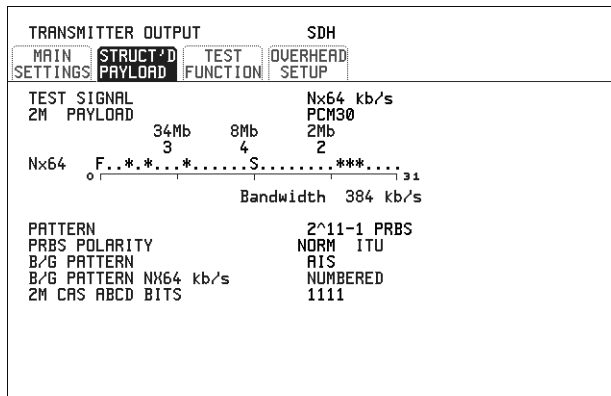

STATUS:

MULTIPLE WINDOW

HOW TO:

- 1 Choose the required Test Signal rate.
- 2 Choose the Framing pattern of the 2M or DS1 PAYLOAD.
- 3 Choose the test timeslots within the structured payload using **DESELECT ALL**, **DESELECT**, **SELECT**, **←** and **→** softkeys. As each timeslot is selected, an * marks the chosen timeslot. In the example above Timeslots 3, 5, 9, 25, 26, 27 are selected for test.
- 4 Choose the PATTERN type and PRBS polarity.
- 5 Choose the B/G PATTERN.
- 6 The B/G PATTERN in the non-test 64 kb/s timeslots is fixed as NUMBERED, that is, each timeslot contains a unique identification number.

Selecting Test Features

Setting Transmit N x 64 kb/s/N x 56 kb/s Structured Payload/Test Signal

Signaling

- 7** If a 2 Mb/s PAYLOAD with PCM30 or PCM30CRC framing, or 56 kb/s or Nx56kb/s Test Signal is chosen. See, "Setting up Signaling Bits " page 67.

Setting Receive N x 64 kb/s/N x 56 kb/s Structured Payload/Test Signal

Description

Wideband services such as high speed data links and LAN interconnection require a bandwidth greater than 56/64 kb/s but less than DS1/2 Mb/s e.g. 128 kb/s or 384 kb/s. These wideband signals are sent in a DS1/2 Mb/s frame by sharing the signal across multiple timeslots.

N x 64kb/s and N x 56 kb/s structured payload/test signal allows the test Timeslots to be chosen for error measurement even when the Timeslots are non contiguous.

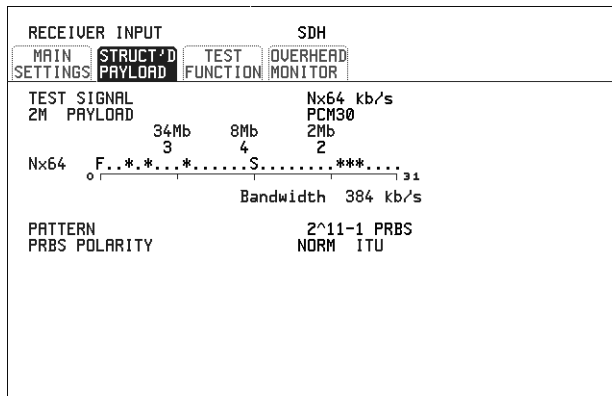

STATUS:

MULTIPLE WINDOW

HOW TO:

- 1 Choose the required Test Signal rate.
- 2 Choose the Framing pattern of the 2M or DS1 PAYLOAD.
- 3 Choose the test timeslots within the structured payload using **DESELECT ALL**, **DESELECT**, **SELECT**, **←** and **→** softkeys. As each timeslot is chosen an * marks the chosen timeslot. In the example above Timeslots 3, 5, 9, 25, 26, 27 are chosen for test.
- 4 Choose the PATTERN type and PRBS polarity.

Inserting an External PDH/DSn Payload/Test Signal

Description

You can insert 2 Mb/s, 34 Mb/s or 140 Mb/s into an STM-N line signal when option 012 is fitted. DS3, DS1, E3 and E1 can be inserted when option 014 is fitted.

RATE	Availability	Option
140 Mb/s	SDH Only	012
DS3	SDH & SONET	001, 012, 002
34Mb/s	SDH & SONET	001, 012,002
2Mb/s	PDH, SDH & SONET	001, 012, 002
DS1	DSn, SDH & SONET	001, 012, 002

HOW TO:

Insert 34 Mb/s, DS3 & 140 Mb/s

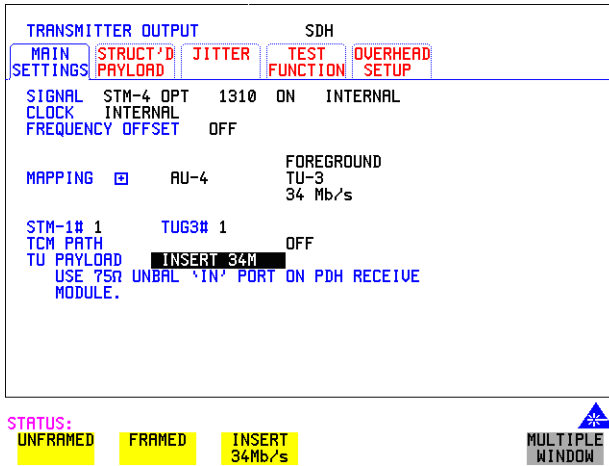

- 1 Press **TRANSMIT**, select **SDH** and the **MAIN SETTINGS** page.
- 2 Set up the required transmit SDH interface, set appropriate MAPPING then choose TU/VT PAYLOAD **INSERT 140 Mb/s**, **INSERT 34 Mb/s** or **INSERT DS3** as required. Connect your external source to the appropriate port as indicated on the instrument display (when you position the cursor on the PAYLOAD TYPE field and select INSERT).

Selecting Test Features

Inserting an External PDH/DSn Payload/Test Signal

Insert 2 Mb/s or DS1 (Unstructured SDH/SONET Payload)

TRANSMITTER OUTPUT		SDH	
MAIN SETTINGS	STRUCT'D PAYLOAD	JITTER TEST FUNCTION	OVERHEAD SETUP
SIGNAL	STM-16 OPT	1310	ON
CLOCK	INTERNAL		INTERNAL
FREQUENCY OFFSET		OFF	
MAPPING	<input checked="" type="checkbox"/> AU-4		BACKGROUND TU-12 ASYNC 2Mb/s
STM-1#	8	TUG3# 2	TUG2# 7
TUN PATH			TUN 1
TU PAYLOAD			OFF
LINE CODE			INSERT 2Mb/s
			HDB3
			USE 'MUX' PORT ON PDH TX MODULE.

STATUS: **PCMS1CRC** **INSERT 2Mb/s** **MORE** **MULTIPLE WINDOW**

- 1 Connect the external payload to the MUX port of the PDH Transmit module. If 2 Mb/s connect to 75Ω MUX port. If DS1 connect to 100Ω MUX port.
- 2 Set up the required transmit SDH interface, and choose TU12 MAPPING or TU11 MAPPING and TU PAYLOAD **INSERT 2 Mb/s** or **INSERT DS1**.

Insert 2 Mb/s or DS1 (Structured SDH Payload or Structured PDH)

TRANSMITTER OUTPUT		SDH	
MAIN SETTINGS	STRUCT'D PAYLOAD	TEST FUNCTION	OVERHEAD SETUP
TEST SIGNAL			2 Mb/s
2M PAYLOAD			INSERT 2Mb/s
LINE CODE			HDB3
		8Mb	2Mb
		4	2
B/G PATTERN			A1S

STATUS: **PCMS1CRC** **INSERT 2Mb/s** **MORE** **MULTIPLE WINDOW**

- 1 Connect the external payload to the MUX port of the PDH Transmit module. If 2 Mb/s connect to 75Ω MUX port. If DS1 connect to 100Ω MUX port.

Structured SDH Payload

- 2 Set up the required transmit SDH interface. See "Setting SDH Transmit Interface " page 29.

Selecting Test Features

Inserting an External PDH/DSn Payload/Test Signal

- 3 Set up the SDH structured payload. See "Setting Transmit Structured Payload/Test Signal " page 70.
- 4 Choose 2M PAYLOAD/DS1 PAYLOAD **INSERT 2 Mb/s** or **INSERT DS1** .
- 5 Choose the LINE CODE.

Structured PDH

- 6 Set up, the required transmit PDH interface, See "Setting PDH/DSn Transmit Interface (option 012) " page 26.
- 7 Set up the PDH Test Signal interface. See "Setting Transmit Structured Payload/Test Signal " page 70
- 8 Choose 2M PAYLOAD/DS1 PAYLOAD **INSERT 2 Mb/s** or **INSERT DS1** .
- 9 Choose the LINE CODE.

Selecting Test Features
Dropping an External Payload/Test Signal

Dropping an External Payload/Test Signal

Description

You can drop 2Mb/s, 34 Mb/s or 140 Mb/s from an STM-N line signal when option 012 is fitted. DS3, DS1, E3 and E1 can be dropped when option 014 is fitted

RATE	Availability	Option
140 Mb/s	SDH Only	012 Only
DS3	SDH & SONET	001, 012, 002
34Mb/s	SDH & SONET	001, 012, 002
2Mb/s	PDH, SDH & SONET	001, 012, 002
DS1	DSn, SDH & SONET	001, 012, 002

HOW TO:

Drop 34 Mb/s, DS3 & 140 Mb/s

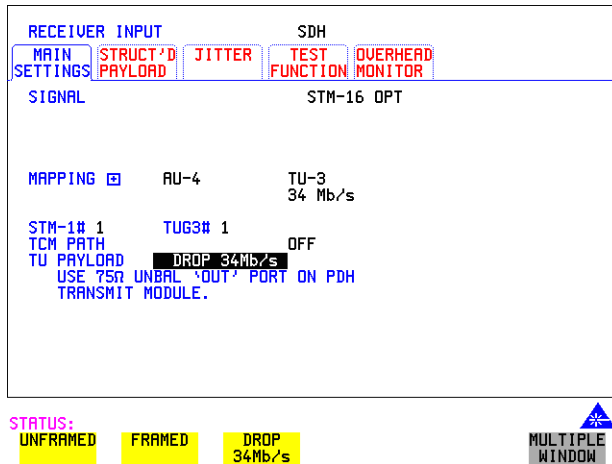

- 1 Connect the 75Ω OUT port of the PDH Tx module to the external equipment.
- 2 Set up the receive SDH interface, and choose TU PAYLOAD **DROP 140 Mb/s**, **DROP 34 Mb/s** or **DROP DS3**.
 If **DROP DS3** is chosen, choose the DS3 output level.

Selecting Test Features

Dropping an External Payload/Test Signal

Drop 2 Mb/s /DS1 (Unstructured SDH Payload)

RECEIVER INPUT		SDH	
MAIN SETTINGS	STRUCT'D PAYLOAD	JITTER	TEST FUNCTION OVERHEAD MONITOR
SIGNAL		STM-16 OPT	
MAPPING <input checked="" type="checkbox"/>	AU-4	TU-11 ASYNC DS1	
STM-1# 3	TUG3# 2	TUG2# 6	TU# 3
TCM PATH		OFF	
TU PAYLOAD	DROP DS1		
LINE CODE	AMI		
USE 'DEMUX' PORT ON PDH RX MODULE			

STATUS:

UNFRAMED	D4	ESF	SLC-96	DROP DS1	MULTIPLE WINDOW
----------	----	-----	--------	----------	-----------------

- 1 Connect the DEMUX port of the PDH module to the external equipment.
- 2 Set up the required receive SDH interface, and choose TU12 MAPPING or TU11 MAPPING and TU PAYLOAD **DROP 2 Mb/s** or **DROP DS1**.
- 3 Choose the required LINE CODE.

Selecting Test Features

Dropping an External Payload/Test Signal

Drop 2 Mb/s/DS1 (Structured SDH Payload or Structured PDH)

RECEIVER INPUT		SDH	
MAIN SETTINGS	STRUCT'D PAYLOAD	TEST FUNCTION	OVERHEAD MONITOR
TEST SIGNAL	2M PAYLOAD	8Mb	2 Mb/s
LINE CODE		4	DROP 2Mb/s
			HDB3
			2Mb
			2

STATUS:
PCM31CRC **DROP 2Mb/s** MORE **MULTIPLE WINDOW**

- 1 Connect the DEMUX port of the PDH module to the external equipment.
If 2 Mb/s connect to 75Ω DEMUX port. If DS1 connect to 100Ω DEMUX port.

Structured SDH Payload

- 2 Set up the required receive SDH interface see "Setting SDH Receive Interface " page 49.
- 3 Set up the SDH structured payload, see "Setting Receive Structured Payload/Test Signal " page 72.
- 4 Choose 2M PAYLOAD/DS1 PAYLOAD **DROP 2 Mb/s** or **DROP DS1** .
- 5 Choose the LINE CODE.

Structured PDH

- 6 Set up, the required receive PDH interface, see "Setting PDH/DSn Receive Interface (Option 012) " page 47.
- 7 Set up the PDH Test Signal interface, see "Setting Receive Structured Payload/Test Signal " page 72
- 8 Choose 2M PAYLOAD/DS1 PAYLOAD **DROP 2 Mb/s** or **DROP DS1** .
- 9 Choose the LINE CODE.

Selecting Test Features

Adding Errors & Alarms at the SDH Interface

Adding Errors & Alarms at the SDH Interface

Description

Errors and alarms can be added on the SDH signal during testing.

TRANSMITTER OUTPUT		SDH	
MAIN SETTINGS	STRUCT'D PAYLOAD	TEST FUNCTION	OVERHEAD SETUP
TEST FUNCTION	SDH	ERR & ALARM	
ERROR ADD TYPE		B2 BIP	
RATE	100 ERRORS IN	MSP THRESHLD	10 MS
ALARM TYPE		AU-LOP	

STATUS:

MULTIPLE WINDOW

HOW TO:

- 1 Set up the SDH transmit interface and payload required. See "Setting SDH Transmit Interface " page 29.
- 2 Select **TEST FUNCTION** , SDH, ERR & ALARM as shown above.
- 3 Choose the ERROR ADD TYPE and RATE required.
Errors can be added at preset rates and at USER programmable rate. With the exception of ENTIRE FRAME, A1A2 FRAME and BIT, errors can be added at ERROR ALL rate.
If B2 BIP errors are chosen errors can be added to trigger an MSP THRESHOLD. This takes the form of N errors in T time period. N and T are both selectable.
- 4 Choose the ALARM TYPE
Errors and Alarms can be added at the same time.

Selecting Test Features
Adding Errors & Alarms to a PDH signal

Adding Errors & Alarms to a PDH signal

Description
Option 012 is required for PDH operation.

Errors and alarms can be added to a PDH signal during testing.

TRANSMITTER OUTPUT		SDH	
MAIN SETTINGS	STRUCT'D PAYLOAD	TEST FUNCTION	OVERHEAD SETUP
TEST FUNCTION	PDH PAYLD	ERR & ALARM	
ERROR ADD TYPE		FAS (LINE)	
RATE		1E-5	
ALARM TYPE		CAS MFM LOSS	

STATUS:

MULTIPLE WINDOW

HOW TO:

- 1 If SDH interface is chosen, set up the SDH transmit interface and payload required. See “Setting SDH Transmit Interface” page 29.
If PDH interface is chosen, set up the PDH interface and payload required. See “Setting PDH/DSn Transmit Interface (option 012)” page 26.
- 2 Choose the ERROR ADD TYPE and RATE on the Transmitter **TEST FUNCTION** display.
The RATE can be selected from a fixed value or is user programmable. If you select USER PROGRAM you can select the error rate before enabling the errors. This feature is useful for error threshold testing.
- 3 Choose the ALARM TYPE.
Errors and Alarms can be added at the same time.

Selecting Test Features

Using FEAC Codes

Using FEAC Codes

Description

Option 012 required

The third C-Bit in subframe 1 is used as a FEAC channel, where alarm or status information from the far-end terminal can be sent back to the near-end terminal. The channel is also used to initiate DS3 and DS1 line loopbacks at the far-end terminal from the near-end terminal.

The codes are six digits long and are embedded in a 16 bit code word; the format is 0XXXXXX01111111.

There are two types of code, Loopback and Alarm Status.

Loopback provides a choice of two DS1 messages and two DS3 Messages. The DS1 Messages can be sent in ALL DS1 channels or in a SINGLE channel. The message can be repeated up to 15 times.

Alarm Status provides 13 preset codes and a USER programmable code function. These codes can be transmitted continuously or in bursts.

The new code is transmitted by choosing **BURST** or **ON**.

TRANSMITTER OUTPUT		PDH/DSn
MAIN SETTINGS	STRUCT'D SETTINGS	TEST FUNCTION
TEST FUNCTION	DSn	ERR & ALARM
ERROR ADD TYPE		BIT (TEST)
RATE		OFF
ALARM TYPE		DS3 FEAC
FEAC CODE TYPE		LOOPBACK
MESSAGE	ACTIVATE DS1	2
REPEAT (TIMES)	15 LOOP	15 MESS.
TRANSMIT NEW CODE		OFF

STATUS:

OFF LOS DS3 AIS DS3 OOF MORE MULTIPLE WINDOW

HOW TO:

Transmit an FEAC code

- 1 Choose SIGNAL **DS3** and PAYLOAD TYPE **CBIT** on the **TRANSMIT MAIN SETTINGS** display.
- 2 Choose **TRANSMIT TEST FUNCTION**, DSn and ALARM TYPE **DS3 FEAC**. When a FEAC code is not being transmitted, an all ones pattern is transmitted.

Selecting Test Features

Using FEAC Codes

- 3 Choose the FEAC CODE TYPE.
- 4 Choose the MESSAGE from the choices displayed.
If you chose a DS1 message an additional field to the right of the DS1 MESSAGE is displayed. Position the cursor on this field and choose **ALL** or **SINGLE CHANNEL**.
If you choose **SINGLE CHANNEL** use the EDIT keys to select a channel from 1 to 28. Press **END EDIT** when finished.
- 5 If **LOOPBACK** is chosen, choose the REPEAT (TIMES) LOOP and MESS, in the range 1 to 15.
- 6 If **ALARM/ STATUS** is chosen, choose the BURST LENGTH (TIMES).
- 7 Choose TRANSMIT NEW CODE **BURST** or **ON** to transmit the selected FEAC message.

TIP:

To View FEAC Messages

The received FEAC message can be viewed on the **RESULTS** display.

```
RESULTS  DSn          FEAC MESSAGE

CURRENT FEAC MESSAGE
  IDLE (All Ones)
LAST NON-IDLE FEAC MESSAGE
  000000
  DS3 Out of Frame

ELAPSED TIME          00d 00h 00m 03s
```

STATUS:
ERROR SUMMARY CUMUL-ATIVE SHORT TERM ERROR ANALYSIS MORE MULTIPLE WINDOW

Setting PDH Spare Bits

Description

Certain Spare Bits will cause the occurrence of a minor alarm when received as a logical "0".:

- 140 Mb/s - FAS Bit 14
- 34 Mb/s - FAS Bit 12
- 8 Mb.s - FAS Bit 12
- 2 Mb/s - NFAS Timeslot (timeslot 0 of NFAS frame) Bit 0

TRANSMITTER OUTPUT		SDH	
MAIN SETTINGS	STRUCT'D PAYLOAD	TEST FUNCTION	OVERHEAD SETUP
TEST FUNCTION	PDH PAYLD	SPARE BITS	
140M: FAS BITS 14-16		111	
34M: FAS BIT 12		1	
8M: FAS BIT 12		1	
2M: S _i BITS CRC4 FRAME E-BITS		11	
S _a BITS (NFAS T/S BITS 4-8)		11111	
S _a BIT SEQUENCE 11111111	IN BIT 4	OFF	
SEND SEQUENCE			

STATUS:

MULTIPLE WINDOW

HOW TO:

- 1 If SDH interface is chosen, set up the SDH transmit interface and payload required. See "Setting SDH Transmit Interface " page 29.
 If PDH interface is chosen, set up the PDH transmit interface and payload required. See "Setting PDH/DSn Transmit Interface (option 012) " page 26.
- 2 Set the value of the spare bits required for testing.
 If a BIT SEQUENCE is required, choose SEND SEQUENCE **ON** to transmit the sequence.

Adding Pointer Adjustments

Introduction

Pointers perform a critical role in the error free transmission of payload data (subscriber data) through a SDH network. They also enable individual payload channels to be inserted or extracted from a high speed STM-n line signal (for example the functionality provided by ADM's).

Pointer adjustments are often necessary to compensate for asynchronous operation between different nodes within an SDH network. These adjustments however can result in jitter being added to a PDH signal output from an SDH network element.

Jitter caused by Pointer Adjustments

Pointer adjustments are the mechanisms within SDH used to compensate for frequency and phase differences between VCs and the outgoing SDH frames. These pointer adjustments are byte wide and since they can occur randomly, they may cause significant amounts of payload signal jitter. It is therefore necessary to control the jitter on payload signals that is due to pointer adjustments.

Pointer adjustment activity within a network can be randomly spaced individual pointer adjustments, pointer bursts or periodic pointer adjustments.

The ITU-T G.783 and ETSI TM-1015 standards defines a set of pointer sequences to be used when evaluating an NE's pointer adjustment jitter performance.

The OmniBER 718 generates a set of test sequences which can be used to simulate network pointer adjustment activity. This allows the amount of tributary jitter due to different types of pointer adjustment to be measured in the OmniBER 718.

Selecting Test Features

Adding Pointer Adjustments

Description

The transmitted AU or TU pointer value can be adjusted for testing purposes.

TRANSMITTER OUTPUT		SDH	
MAIN SETTINGS	STRUCT'D PAYLOAD	TEST FUNCTION	OVERHEAD SETUP
TEST FUNCTION	SDH	ADJUST PTR	
POINTER TYPE	TU POINTER		
ADJUSTMENT TYPE	G.783 PHASE TRANSIENT		
POLARITY	POSITIVE		
REPEAT	30 s		
POINTER SEQUENCES	STOPPED		

STATUS:

MULTIPLE WINDOW

HOW TO:

- 1 Set up the SDH transmit interface and payload required. See "Setting SDH Transmit Interface" page 29.
- 2 Choose the POINTER TYPE.
- 3 Choose the ADJUSTMENT TYPE required.

BURST - You determine the size of the burst by the number of PLACES chosen. If, for example, you choose 5 PLACES the pointer value will be stepped 5 times in unit steps e.g. 0 (start value), 1, 2, 3, 4, 5 (final value). The interval between steps is as follows:
 For AU and TU-3, the minimum spacing between adjustments is 500 us. For TU except TU-3, the minimum spacing between adjustments is 2 ms.
 Choose ADJUST POINTER [ON] to add the chosen burst.

NEW POINTER - You can choose any pointer value in the range 0 to 782 with or without a New Data Flag.
 The current pointer value is displayed for information purposes.
 Choose ADJUST POINTER [ON] to transmit the new pointer value.

OFFSET - You can frequency offset the line rate or the VC/TU rate, relative to each other, thus producing pointer movements. If you offset the AU pointer, an 87:3 sequence of pointer movements is generated. The available configurations are listed in the following table.
 If you are currently adding Frequency Offset to the SDH interface or payload, pointer OFFSET is not available.

Selecting Test Features

Adding Pointer Adjustments

Pointer Type	Line Rate	AU Payload (VC) Rate	TU Payload (TU) Rate
AU	Constant	Offset	Tracks AU Payload
AU	Offset	Constant	Constant
TU	Constant	Constant	Offset
TU	Offset	Tracks Line Rate	Constant

G.783 - Provides pointer movements according to ITU-T G.783:

Choose the G.783 ADJUSTMENT TYPE.

Choose the POLARITY, INTERVAL and PATTERN (where applicable) for the selected sequence.

Choose POINTER SEQUENCES **START INIT** to generate the selected G.783 sequence and **STOP INIT** to stop the pointer sequences.

G.783 Pointer Sequences Explained

In addition to the BURST, NEW POINTER and OFFSET pointer movements described, the OmniBER 718 can also generate pointer sequences (pointer movements) according to ITU-T G.783, T1.105.03 and GR-253. Note that T.105.03/GR-253 sequences are explained in the SONET version of this User's Guide.

Before running a pointer sequence you can elect to run an initialization sequence, followed by a cool down period, and then run the chosen sequence. This is selected using the **START INIT** key shown in the display on the previous page. Initialized pointer sequences are made up of three periods: the *Initialization Period*, the *Cool Down Period*, and the *Sequence (Measurement) Period*, illustrated in the following figure:

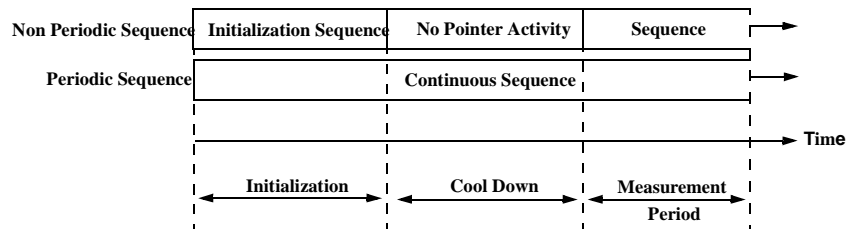

Note: SINGLE (e), BURST (f) and PHASE TRANSIENT are Non Periodic Sequences.

Selecting Test Features

Adding Pointer Adjustments

Initialization Period

For SINGLE e), BURST f) and PHASE TRANSIENT sequences the initialization sequence consists of 60 seconds of pointer adjustments applied at a rate of 2 adjustments per second and in the same direction as the specified pointer sequence.

Cool Down Period

A period following the initialization period which for SINGLE e), BURST f) and PHASE TRANSIENT sequences is 30 seconds long when no pointer activity is present.

Sequence (Measurement) Period

The period following the Cool Down period where the specified pointer sequence runs continuously.

Periodic Test Sequences

For periodic test sequences (for example “PERIODIC ADD g/h”) both the 60 second initialization and 30 second cool down periods consist of the same sequence as used for the subsequent measurement sequence. If the product of the period T and the selected optional background pattern (87+3 or 26+1) exceeds 60 seconds then the longer period is used for the initialization. For example, if T is set for 10 seconds then the initialization period may be extended to 900 seconds.

The OmniBER 718 displays a message indicating which phase (initialization, cool down or measurement) the transmitter is currently generating.

NOTE

The following conditions apply for pointer sequence generation:
The sequences can only be applied to the AU pointer when the AU does not contain a TU structure, otherwise it is applied to the TU pointer. Pointer sequence generation is not available when a frequency offset is being applied to the Line Rate.

The following figure gives an example of a G.783 (g) 87-3 Pointer Sequence.

Selecting Test Features
Adding Pointer Adjustments

G.783(g) 87-3 Pattern

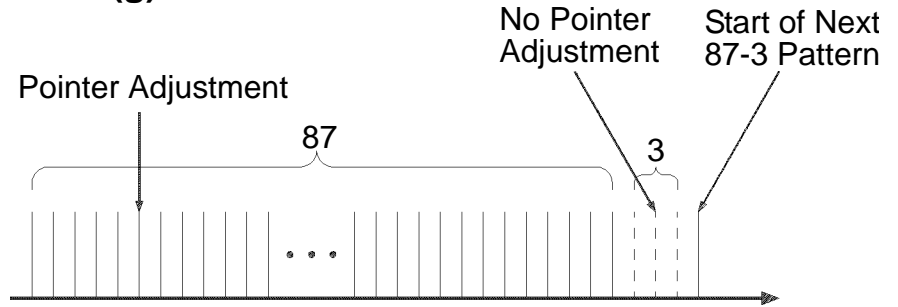

An Example of a Pointer Sequence

Pointer Sequence	Description
G.783(a) PERIODIC SINGLE	Periodic Single adjustments, each with opposite polarity to the preceding adjustment. The interval between pointer adjustments is user selectable (see Note 1 page 93).
G.783 (b) PERIODIC ADD	Periodic Single adjustments, with selectable polarity and added adjustment (1 extra). The spacing between the added adjustment and the previous adjustment is set to the minimum, (see Note 2 page 93). The interval between pointer adjustments is user selectable (see Note 1). Added adjustments occur every 30 seconds.
G.783 (c) PERIODIC CANCEL	Periodic Single adjustments, with selectable polarity and cancelled adjustment (1 less). The interval between pointer adjustments is user selectable (see Note 1 page 93). Cancelled adjustments occur every 30 seconds.
G.783(d) PERIODIC DOUBLE	Periodic Double adjustments (pair of adjustments). The pair alternate in polarity. The spacing between pairs of adjustments, of like polarity is set to the minimum (see Note 2). The interval between pointer adjustments is user selectable (see Note 1).
G.783 (e) SINGLE	Periodic Single adjustments, all of the same polarity which is selectable. Separation between pointer adjustments is fixed at approximately 30 seconds.

Selecting Test Features
Adding Pointer Adjustments

Pointer Sequence	Description
G.783 (f) BURST	Periodic bursts of 3 adjustments, all of the same polarity which is selectable. The interval between bursts is fixed at approximately 30 seconds. The interval between adjustments within a burst is set to the minimum (see Note 2 page 93).
PHASE TRANSIENT	Phase transient pointer adjustment burst test sequence. All adjustments are of the same polarity, which is selectable. The interval between bursts is fixed at 30 seconds. Each burst consists of 7 pointer movement. The first 3 in each burst are 0.25 s apart, and the interval between the 3 and 4 movement, and each remaining movement 0.5 seconds.
G.783 (g) PERIODIC NORMAL (87-3 Pattern)	An 87-3 pattern is selected. The sequence pattern is 87 pointer movements followed by 3 missing pointer movements. Pointer polarity is selectable and the time interval between pointer adjustments settable (see Note 1 page 93).
G.783 (g) PERIODIC ADD (87-3 Pattern)	An 87-3 pattern is selected. The sequence pattern is 87 pointer movements followed by 3 missing pointer movements with an added pointer movement after the 43rd pointer. The spacing between the added adjustment and the previous adjustment is set to the minimum, (see Note 2 page 93). Pointer polarity is selectable. The time interval between pointer adjustments can be set (see Note 1). Added adjustments occur every 30 seconds or every repeat of the 87-3 pattern, whichever is longer.
G.783 (g) PERIODIC CANCEL (87-3 pattern)	An 87-3 pattern is selected. The sequence pattern is 87 pointer movements followed by 3 missing pointer movements with a cancelled pointer movement at the 87th pointer. Pointer polarity is selectable, and the time interval between pointer adjustments can be set (see Note 1). Cancelled adjustments occur every 30 seconds or every repeat of the 87-3 pattern, whichever is longer.
G.783 (h) PERIODIC NORMAL (Continuous Pattern)	Provides a continuous sequence of pointer adjustments. The polarity of the adjustments is selectable, and the time interval between adjustments can be set (see Note 1).
G.783 (h) PERIODIC ADD (Continuous Pattern)	Periodic Single adjustments, with selectable polarity and added adjustment (1 extra). The spacing between the added adjustment and the previous adjustment is set to the minimum, (see Note 2). The time interval between pointer adjustments can be set (see Note 1). Added adjustments occur every 30 seconds or every repeat of the 87-3 pattern, whichever is longer.

Selecting Test Features
Adding Pointer Adjustments

Pointer Sequence	Description
G.783 (h) PERIODIC CANCEL (Continuous Pattern)	Periodic Single adjustments, with selectable polarity and cancelled adjustment (1 less). The time interval between pointer adjustments can be set (see Note 1). Cancelled adjustments occur every 30 seconds or every repeat of the 87-3 pattern, whichever is longer.
PERIODIC NORMAL (26-1 Pattern)	This selection is only available if you have selected TU11 mapping, or TU12 with ASYNC DS1 selected. The sequence pattern is 26 pointer movements followed by 1 missing pointer movement. Pointer polarity is selectable and the time interval between pointer adjustments programmable to 200 ms, 500 ms, 1 s, 2 s, 5 s or 10 seconds.
PERIODIC ADD (26-1 Pattern)	This selection is only available if you have selected TU11 mapping, or TU12 with ASYNC DS1 selected. The sequence pattern is 26 pointer movements followed by 1 missing pointer movement. The added adjustment occurs 2 ms after the 13th pointer adjustment. Pointer polarity is selectable and the time interval between pointer adjustments programmable to 200 ms, 500 ms, 1 s, 2 s, 5 s or 10 s. Added adjustments occur every 30 seconds or every repeat of the 26-1 pattern, whichever is longer.
PERIODIC CANCEL (26-1 pattern)	This selection is only available if you have selected TU11 mapping, or TU12 with ASYNC DS1 selected. The sequence pattern is 26 pointer movements followed by 1 missing pointer movement. The cancelled adjustment is the 26th pointer adjustment, that is the one before the regular gap of 1. Pointer polarity is selectable and the time interval between pointer adjustments programmable to 200 ms, 500 ms, 1 s, 2 s, 5 s or 10s. Cancelled adjustments occur every 30 seconds or every repeat of the 26-1 pattern, whichever is longer.

Pointer Sequence Notes

Note 1: For AU and TU-3, the sequence interval is selectable from:
7.5 ms, 10, 20, 30, 34 ms, 40 to 100 ms in 10 ms steps, 100 to 1000 ms in 100 ms steps, 1, 2, 5, 10 seconds.
For TU except TU-3, the sequence interval is selectable from:
200 ms, 500 ms, 1, 2, 5 and 10 seconds.

Selecting Test Features
Adding Pointer Adjustments

Note 2: For AU and TU-3, the minimum spacing between adjustments is 500 us.
 For TU except TU-3, the minimum spacing between adjustments is 2 ms.

Table 4 O.172 - G.783 pointer test sequence description

G.783 Pointer Test Sequence	SDH tributary bit rate (kbits) and SDH container					
	1.544 TU-11	2.048 TU-12	6.312 TU-2	34.368 TU-3	44.736 AU-3	139.264 AU-4
G.783(a) Periodic Single		X		X		X
G.783 (b) Periodic Add		X		X		X
G.783 (c) Periodic Cancel		X		X		X
G.783 (d) Periodic Double				X		X
G.783 (e) Single	X		X		X	
G.783 (f) Burst	X		X		X	
G.783 (g) Periodic Normal (87-3 Pattern)					X	X
G.783 (g) Periodic Add (87-3 Pattern)					X	X
G.783 (g) Periodic Cancel (87-3 Pattern)					X	X
G.783 (h) Periodic Normal	X		X		X	
G.783 (h) Periodic Add	X		X		X	
G.783 (h) Periodic Cancel	X		X		X	

Selecting Test Features

Using Pointer Graph Test Function

Using Pointer Graph Test Function

Pointer Graph shows the relative offset during the measurement period. This allows the time relationship of AU or TU pointer movements to be observed. Up to 4 days of storage allows long term effects such as Wander to be observed. If an alarm occurs during the measurement period, a new graph starts at the centre of the display (offset zero) after recovery from the alarm.

The Pointer Graph display can be logged to the chosen logging device. See "Logging on Demand " page 261.

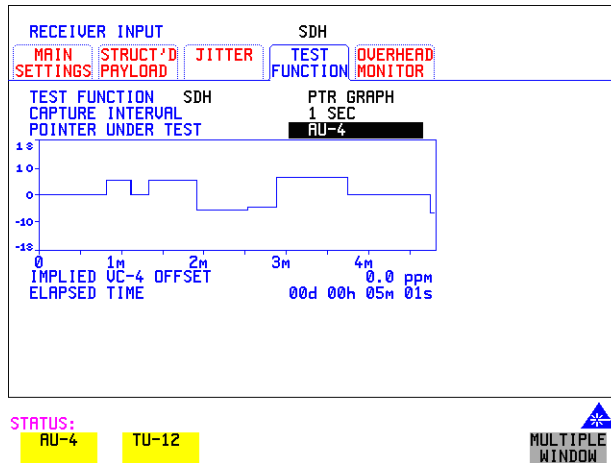

TIP:

The graph can also be viewed on the **RESULTS** **SDH RESULTS** display at the end of the measurement.

HOW TO:

- 1 Set up the receive SDH interface and payload as required. See "Setting SDH Receive Interface" page 49.
- 2 On the RECEIVE Test Function page, select **PTR GRAPH** then choose the CAPTURE INTERVAL required.
The capture interval determines the time between captures. Low values of capture interval should be chosen when a high degree of pointer movements is expected. High values of capture interval should be chosen when a low degree of pointer movements is expected, for example Wander over 1 day, use 5 MINS and Wander over 4 days, use 20 MINS.
If, during a long term measurement (4 days), an event occurs at a particular time each day, then the instrument can be set to log the results graph of that event.

Selecting Test Features

Using Pointer Graph Test Function

3 Choose the POINTER UNDER TEST type.

4 Press **RUN/STOP** to start the measurement.

TIP:

If the event occurs outside normal working hours, a Timed Start measurement can be made.

The values of capture interval available and the approximate total capture window is as follows:

1 SEC - display window of approximately 5 minutes.

5 SECS - display window of approximately 25 minutes.

20 SECS - display window of approximately 1 hour 40 minutes.

1 MIN - display window of approximately 5 hours.

5 MIN - display window of approximately 1 day.

20 MIN - display window of approximately 4 days.

Stressing Optical Clock Recovery Circuits

Description

This test is essentially designed for testing optical clock recovery circuits in the presence of long runs of zero's or one's (after scrambling). The test function page allows control of the test pattern and the block length. The maximum block length is 2 bytes less than the width of the Virtual Container.

When the test is enabled, the instrument applies the selected pattern immediately after the first row of Section Overhead bytes **after scrambling**. The location of the start of the pattern is byte 4 at 52 Mb/s (i.e. after the first three bytes of overhead), byte 10 at 155 Mb/s, byte 37 at 622 Mb/s and byte 145 at 2488 Mb/s. The remainder of the Virtual Container will contain the signal structure and pattern as defined on the TRANSMITTER, MAIN SETTINGS page.

The payload is overwritten in such a way that the transmitted B1 and B2 values are correct.

When using this feature to test network equipment clock recovery, long runs of zero's may be inserted at the input of the UUT (unit under test) and by monitoring B1 and B2 at the UUT output, error free transmission can be verified.

The stress test is available at all optical rates.

TRANSMITTER OUTPUT		SDH	
MAIN SETTINGS	STRUCT'D PAYLOAD	TEST FUNCTION	OVERHEAD SETUP
TEST FUNCTION	SDH	STRESS TEST	
STRESSING PATTERN		ALL ONES	
BLOCK LENGTH		0002 BYTES	

STATUS:

MULTIPLE WINDOW

Selecting Test Features

Stressing Optical Clock Recovery Circuits

HOW TO:

- 1** Set up the SDH transmit interface and payload required. See "Setting SDH Transmit Interface " page 29.

Choose the required STRESSING PATTERN.

The G.958 test pattern consists of 7 consecutive blocks of data as follows: the first row of section overhead bytes, ALL ONES, a PRBS, the first row of section overhead bytes, ALL ZEROS, a PRBS and the first row of section overhead bytes.

- 2** If you choose ALL ONES or ALL ZEROS as the stressing pattern, choose the number of bytes in the BLOCK LENGTH.

Generating Automatic Protection Switch (APS) Messages

Description

You can program the K1 and K2 bytes to exercise the APS functions for both LINEAR (IUT-T G.783) and RING (ITU-T G.841) topologies.

The APS Message types are:-

- PASSIVE
- ACTIVE

The following table shows the APS message type availability.

TX	RX	TOPOLOGY	APS Message Types
SDH	PDH/DSn	LINEAR	PASSIVE
SDH	PDH/DSn	RING	PASSIVE
SDH	SDH	LINEAR	PASSIVE or ACTIVE
SDH	SDH	RING	PASSIVE

GENERAL HOWTO:

- 1** Set up the SDH transmit interface and payload required. See "Setting SDH Transmit Interface " page 29.
- 2** Choose the TOPOLOGY required.
- 3** Follow the appropriate HOWTO, listed in the following pages.

Selecting Test Features

Generating Automatic Protection Switch (APS) Messages

PASSIVE APS

HOWTO:

The default APS message type is PASSIVE. The APS message is only transmitted when the **DOWNLOAD** key is pressed.

```
TRANSMITTER OUTPUT SDH
MAIN STRUCT'D TEST OVERHEAD
SETTINGS PAYLOAD FUNCTION SETUP
SETUP APS
NEW TX TOPOLOGY LINEAR PASSIVE
K1 BITS 1->4 0000:NO REQUEST
  BITS 5->8 0000:NULL CHANNEL
K2 BITS 1->4 0000 BRIDGED CHANNEL NO.
  BIT 5 0: 1+1 ARCHITECTURE
  BITS 6->8 000: RESERVED

CURRENT TX CURRENT RX
K1 00000000 K1 00000000
K2 00000000 K2 00000000

TRANSMIT NEW K1/K2 SELECT
```

STATUS: PASSIVE ACTIVE MULTIPLE WINDOW

HOW TO:

- 1 Select PASSIVE APS message type.

NOTE

This step does not apply to RING TOPOLOGY.

- 2 Choose the message to be transmitted.
If LINEAR topology is chosen, choose the CHANNEL, the BRIDGED CHANNEL NO., the ARCHITECTURE and the RESERVED bits you require.
If RING topology is chosen, choose the DESTINATION NODE ID, the SOURCE NODE ID, the type of PATH and the status code (K2 Bits 6->8)
The current TX and RX, K1 and K2, values are displayed for reference only.
- 3 Choose **DOWNLOAD** to transmit the new K1/K2 values.

Selecting Test Features

Generating Automatic Protection Switch (APS) Messages

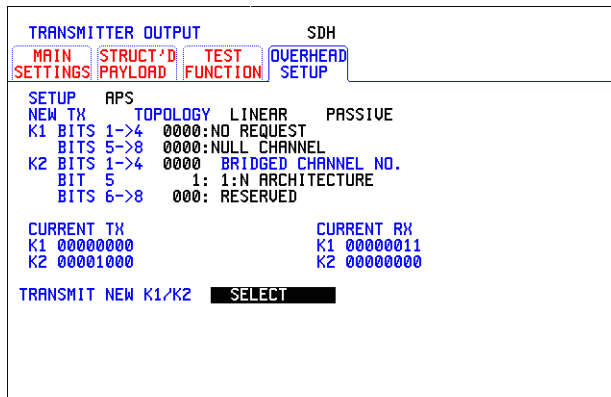

STATUS:

SELECT

DOWN
LOAD

MULTIPLE
WINDOW

ACTIVE APS Message Type

The ACTIVE APS message type gives real-time response to provide switching keep-alive capability. The instrument will not initiate any changes, but will respond to change requests that appear on the input K1/K2 byte values.

The ACTIVE APS message type offers two modes:-

- UNIDIRECTIONAL
- BIDIRECTIONAL

The behaviour for each mode is as shown in the following table.

APS MODE	RX K1 (b5-b8)*	TX K1 (b1-b4)*	TX K1 (b5-b8)*	TX K2 (b1-b4)*	TX K2 (b5)*	TX K2 (b6-b8)*
UNIDIRECTIONAL	xxxx	0000	0000	xxxx	user	100
BIDIRECTIONAL	0000	0000	0000	0000	user	101
BIDIRECTIONAL	yyyy	0010	yyyy	yyyy	user	101

* ITU bit numbering convention

where:

xxxx = any 4-bit binary value.

user = user programmable bit, corresponding to APS ARCHITECTURE.

yyyy = any non-zero 4-bit binary value.

Selecting Test Features

Generating Automatic Protection Switch (APS) Messages

TRANSMITTER OUTPUT SDH

MAIN SETTINGS STRUCT'D PAYLOAD TEST FUNCTION OVERHEAD SETUP

SETUP APS

NEW TX TOPOLOGY LINEAR ACTIVE UNIDIRECTIONAL

K1 BITS 1->8 SET TO 00000000

K2 BITS 1->4 SET IN RESPONSE TO RX VALUE

K2 BIT 5 0: 1+1 ARCHITECTURE

BITS 6->8 100: UNIDIRECTIONAL

CURRENT TX K1 00000000 K2 00110100

CURRENT RX K1 00000011 K2 00000000

TRANSMIT NEW K2 SELECT

STATUS: PASSIVE ACTIVE MULTIPLE WINDOW

HOW TO:

- 1 Select ACTIVE APS message type.
- 2 Select ACTIVE APS message mode.

TRANSMITTER OUTPUT SDH

MAIN SETTINGS STRUCT'D PAYLOAD TEST FUNCTION OVERHEAD SETUP

SETUP APS

NEW TX TOPOLOGY LINEAR ACTIVE UNIDIRECTIONAL

K1 BITS 1->8 SET TO 00000000

K2 BITS 1->4 SET IN RESPONSE TO RX VALUE

K2 BIT 5 0: 1+1 ARCHITECTURE

BITS 6->8 100: UNIDIRECTIONAL

CURRENT TX K1 00000000 K2 00110100

CURRENT RX K1 00000011 K2 00000000

TRANSMIT NEW K2 SELECT

STATUS: UNI-DIRECT BI-DIRECT MULTIPLE WINDOW

Selecting Test Features

Generating Automatic Protection Switch (APS) Messages

- 3 Select the required APS ARCHITECTURE.
- 4 Choose **DOWNLOAD** to transmit the new K1/K2 values.

TRANSMITTER OUTPUT		SDH	
MAIN	STRUCT'D	TEST	OVERHEAD
SETTINGS	PAYLOAD	FUNCTION	SETUP
SETUP	APS	TOPOLOGY	LINEAR ACTIVE
NEW TX			UNIDIRECTIONAL
K1 BITS 1->8	SET TO	00000000	
K2 BITS 1->4	SET IN RESPONSE TO RX VALUE		
K2 BIT 5	1: 1:N ARCHITECTURE		
BITS 6->8	100: UNIDIRECTIONAL		
CURRENT TX		CURRENT RX	
K1 00000000		K1 00000011	
K2 00111100		K2 00000000	
TRANSMIT NEW K2	SELECT		

STATUS:

SELECT

**DOWN
LOAD**

**MULTIPLE
WINDOW**

Inserting and Dropping the Data Communications Channel

Description

The Data Communications Channel (DCC) of the regenerator and multiplexer section overhead can be verified by protocol testing. The Insert and Drop capability provides access to the DCC via the RS-449 connector on the front panel of the SDH module.

DCC INSERT is available on the **TRANSMIT**, **SDH**, **TEST FUNCTION** display.

DCC DROP is available on the **RECEIVE**, **SDH**, **TEST FUNCTION** display.

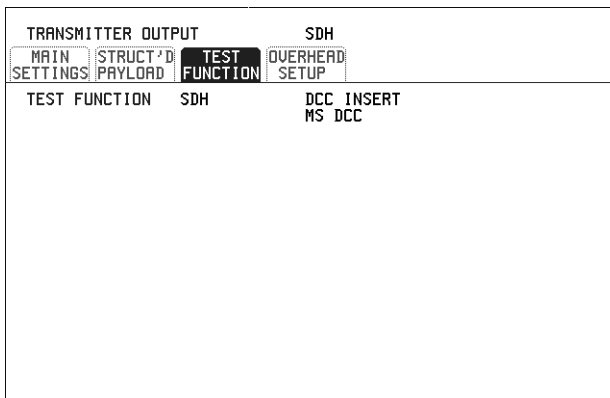

STATUS:

MULTIPLE WINDOW

HOW TO:

- 1 Connect the Protocol Analyzer to the DCC port on the Multirate Analyzer module.
- 2 Choose the required DCC.

Using DS1 LOOP Codes

Description

A loopback code causes the far end equipment to return a signal to the sender, so that the sender can verify signal integrity. Loop codes are used by carriers of the T1 signal and users of the transport medium as a maintenance tool to aid in fault location. Loopback commands are in-band (that is they use the payload space), and out-band (they use an ESF data link).

The OmniBER 718 provides both In-band and Out-band loop codes as follows:

Out-band Loop Codes

Out-band codes are transmitted in an ESF data link, in addition to transmitting the in-band signal in the payload. They are only available when ESF framing is selected on the Transmitter Output **MAIN SETTINGS** page.

Loop type	Activate	Deactivate
Line	11111111 01110000	1111111100011100
Payload	11111111 00101111	11111111 01001100
Network	11111111 01001000	n/a
Universal	n/a	11111111 00100100
User Code	111111110xxxxx0	

Note that when switching from an idle message to a loop-back message, the loop-back message will start following the idle message and not part way through it.

Note that the left most bit is transmitted first, and that when a loop code is not being sent, the idle data link sequence is sent. This is a continuous repetition of the pattern 01111110

In-band Loop Codes

With in-band codes, the transmitted signal comprises the entire payload of the signal, overwriting whatever signal was there before. The signal may be framed or unframed. When framed the framing bits overwrite the loopback code (see “In-Band DS1 Loopcode 156MTS Compatibility” on next page).

Note the user word can be set to any length, between 3 and 8 bits. The left most bit is transmitted first.

Selecting Test Features

Using DS1 LOOP Codes

The following in-band codes can be selected .

Loop type	Activate	Deactivate
Line	00001	001
Payload	1100	1110
Network	11111111 01001000	n/a
User Code	xxxxxxxx	xxxxxxxx

In-Band DS1 Loopcode 156MTS Compatibility

Normal operation is such that DS1 framing bit overwrites the DS1 Loopcode pattern. A selection on the **OTHER MISCELLANEOUS** page enables you to change operation such that DS1 Loopcode is gapped in order to prevent the DS1 framing bit overwriting the DS1 Loopcode pattern. See page 310 In-Band DS1 Loopcode 156MTS Compatibility.

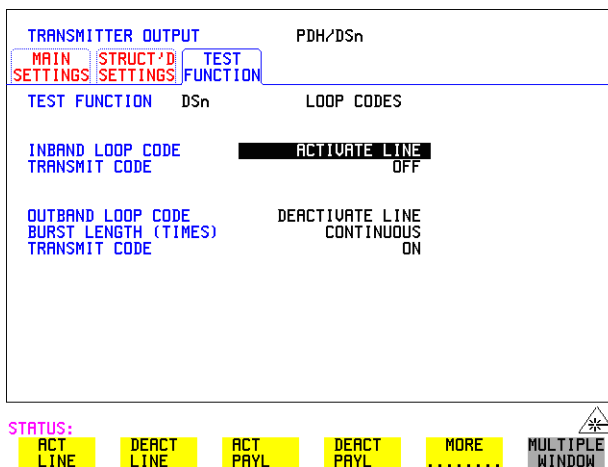

HOW TO:

Transmit an In-band loop code

- 1 Choose SIGNAL **DS1** and set LINE CODE and PAYLOAD TYPE as required on the **TRANSMIT MAIN SETTINGS** display.
- 2 Choose **TRANSMIT TEST FUNCTION** and set the TEST FUNCTION field to **DSn** and **LOOP CODES**.

Selecting Test Features

Using DS1 LOOP Codes

- Choose the INBAND LOOP CODE from the choices given.
- To transmit a code select the TRANSMIT CODE field on the **TRANSMIT TEST FUNCTION**, **DSn**, **LOOP CODES** display and select **BURST**. The code is sent for nominally eight seconds.

HOW TO:

Monitor/view received loop codes

- Choose SIGNAL **DS1** on the **RECEIVE MAIN SETTINGS** display. Also set the LINE CODE to match the setting on the Transmitter display.
- Choose **DSn RESULTS** and **LOOP CODES** on the **RESULTS** display.
- Set the INBAND LOOPUP and LOOPDOWN fields to the required codes. Note the instrument receiver only detects the codes you have chosen. It does not detect other codes in the background. If you wish to view other codes, then you must select them in the appropriate fields.
- View the results in the RESULTS window.

TRANSMITTER OUTPUT PDH/DSn MAIN SETTINGS STRUCT'D SETTINGS JITTER TEST FUNCTION TEST FUNCTION DSn LOOP CODES INBAND LOOP CODE ACTIVATE NETWORK BURST OUTBAND LOOP CODE ACTIVATE LINE CONTINUOUS ON BURST LENGTH (TIMES) TRANSMIT CODE		RECEIVER INPUT PDH/DSn MAIN SETTINGS STRUCT'D SETTINGS JITTER TEST FUNCTION SIGNAL DS1 TERMINATION 1000 BAL LINE CODE AMI LEVEL TERMINATE PAYLOAD TYPE ESF UNSTRUCTURED PATTERN ORSS	
RESULTS DSn LOOP CODES INBAND LOOPUP ACTIVATE NETWORK DETECTED LOOPDOWN DEACTIVATE LINE LAST VALID CODE 11000 ACTIVATE NETWORK OUTBAND CURRENT CODE 111000 ACTIVATE LINE LAST VALID CODE 010100 ACTIVATE PAYLOAD ELAPSED TIME 00d 00h 00m 10s		FUNCTION MISCELLANEOUS KEYBOARD LOCK ON BEEP ON RECEIVED ERROR OFF INBAND DS1 LOOPCODE IS6MTS COMPATIBILITY OFF SUSPEND TEST ON SIGNAL LOSS OFF HS-REI RESULT ENABLE ON GRAPH STORAGE RESOLUTION COMPRESS NOTE: storing graph results with full resolution will reduce storage capacity by 50%	

STATUS: Transmitting inband burst

ACT LINE	ACT PRYL	ACT N/WORK	USER CODE
----------	----------	------------	-----------

 SINGLE WINDOW

HOW TO:

Transmit an Out-band loop code

- Choose SIGNAL **DS1** and set LINE CODE as required, and PAYLOAD TYPE to **ESF** on the **TRANSMIT MAIN SETTINGS** display.
- Choose **TRANSMIT TEST FUNCTION** and set the TEST FUNCTION field to **DSn** and **LOOP CODES**.

Selecting Test Features

Using DS1 LOOP Codes

- 3 Choose the OUTBAND LOOP CODE from the choices given.
- 4 Set the BURST LENGTH to **CONTINUOUS** or **BURST**. The BURST length can be set from 1 to 15 times.
- 5 To transmit the code set the TRANSMIT CODE field on the **TRANSMIT TEST FUNCTION** field to **ON** or **BURST** as required.

HOW TO:

Monitor/view received loop codes

- 6 Choose SIGNAL **DS1** and PAYLOAD TYPE **ESF** on the **RECEIVE MAIN SETTINGS** display. Also set the LINE CODE to match the setting on the Transmitter display.
- 7 Choose **DSn RESULTS** and **LOOP CODES** on the **RESULTS** display.
- 8 View the CURRENT CODE and LAST CODE results in the RESULTS window.

“Using Overhead BER Test Function”	page 110
“Test Timing”	page 111
“Performing a Trouble Scan”	page 112
“Making SDH Analysis Measurements”	page 114
“Making PDH Analysis Measurements”	page 115
“Measuring Frequency”	page 116
“Measuring Optical Power”	page 117
“Measuring Round Trip Delay”	page 118
“Monitoring Signaling Bits”	page 120
“Measuring Service Disruption Time”	page 121
“Performing an SDH Tributary Scan”	page 124
“Performing an SDH Alarm Scan”	page 127
“Performing a PDH/DSn Alarm Scan”	page 128
“Measuring Jitter”	page 129
“Measuring Extended Jitter”	page 131
“Measuring Wander”	page 133
“Measuring Jitter Tolerance”	page 137
“Measuring Jitter Transfer”	page 142
“Measuring Pointer Adjustment (Tributary) Jitter”	page 148

Making Measurements

Making Measurements

Using Overhead BER Test Function

Using Overhead BER Test Function

Description

You can perform a Bit Error Rate test on chosen bytes of the regenerator section, multiplexer section and path overhead bytes.

The OVERHEAD BER controls are located under **TEST FUNCTION** in the TRANSMITTER and RECEIVER windows.

RECEIVER INPUT		SDH	
MAIN	STRUCT'D	TEST	OVERHEAD
SETTINGS	PAYLOAD	FUNCTION	MONITOR
TEST FUNCTION	SDH	OVERHEAD	BER
MEASURE PRBS FROM	O/H	BYTE	RSDH E1
ERROR COUNT			4
ERROR RATIO			1.953E-06
ERROR FREE SECONDS			28
%ERROR FREE SECONDS			87.500
PATTERN LOSS SECONDS			0
ELAPSED TIME			00d 00h 00m 32s

STATUS:

MULTIPLE WINDOW

HOW TO:

- 1 Set up the SDH transmit interface and payload required. See "Setting SDH Transmit Interface " page 29.
- 2 Set up the receive SDH interface and payload as required. See "Setting SDH Receive Interface " page 49.
- 3 Choose the overhead byte to be tested on the **RECEIVE SDH TEST FUNCTION** display.
- 4 Choose the overhead byte to be tested on the **TRANSMIT SDH TEST FUNCTION** display.
- 5 Press **RUN/STOP** to start the test.
- 6 The PRBS pattern can be errored by pressing **SINGLE**.

Test Timing

Description

There are two aspects to test timing:

- Error results may be displayed as short term or cumulative over the measurement period. If short term error measurements are required, the short term period may be selected.
- The period of the test may be defined or controlled manually.

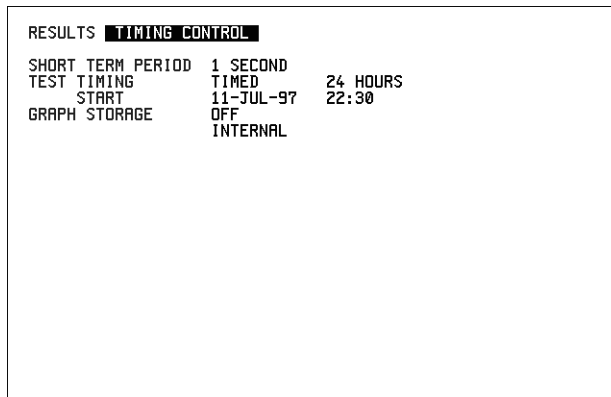

HOW TO:

- 1 Choose **TIMING CONTROL** on the **RESULTS** display.
- 2 Set the SHORT TERM PERIOD required for short term results.
- 3 Choose the type of TEST TIMING required:
For manual control with **RUN/STOP** choose **MANUAL**.
For a single timed measurement period started with **RUN/STOP**, choose **SINGLE** and choose the Test duration.
For a timed period starting at a specified time, choose **TIMED**, choose the Test duration and the test START date and time.

Performing a Trouble Scan

When first connecting to the network it can be useful to have an indication of any problems that exist before starting testing. In OmniBER this feature is provided by Trouble Scan.

All possible error sources and alarms are scanned simultaneously. If any error counts are not zero then these are displayed. Up to 4 non-zero error counts are displayed in priority order.

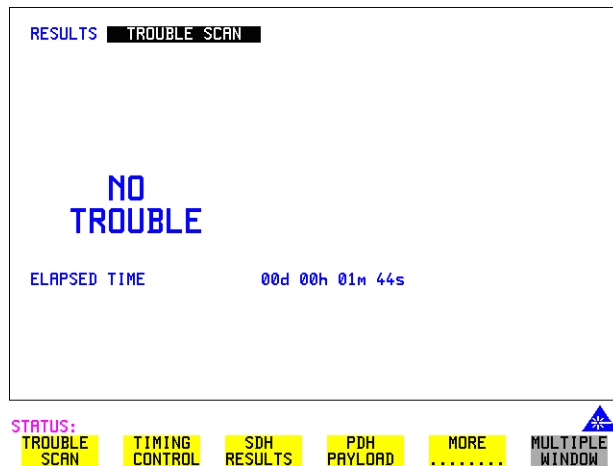

If all error counts are zero and any alarms are detected "ALARMS DETECTED" is displayed.

SHOW and the alarm led's can be used to determine which alarms were detected.

If no alarms are detected and all error counts are zero then "NO TROUBLE" is displayed.

Error Count Priority - see the Table on the following page for a list of error count priorities. The Table lists the error types in order of importance, most important at the top of table.

Making Measurements
Performing a Trouble Scan

Error Count Priority

PDH	DSn	SDH	SONET	ATM
CRC CODE FAS 140M FAS 34M FAS 8M FAS 2M REBE BIT	CRC CODE DS3FR (DS1FR) P-BIT C-BIT FEBE BIT	B1 BIP B2 BIP B3 BIP TC-ERROR TU BIP FRAME CRC FAS2 (DS3FR, DS1FR) MS REI HP REI TC IEC OEI TC-REI LP REI BIT	CV-S CV-L CV-P CV-V FRAME CRC DS3FR (DS1FR, FAS2) REI-L REI-P REI-V BIT	Corrected HEC Non Corrected HEC Received Cells CLP0 Received Cells CLP1 Received Cells CLP0+1 Errored Cells Lost Cells Misinserted Cells Bit Error Non-conforming Cells

POS Errors Priority

POS errors are displayed with priority beneath physical layer trouble scan errors.

The order for display, in descending order is:

- FCS Errors
- IP Header Errors
- IP Payload Errors

All POS alarms are monitored.

Making Measurements

Making SDH Analysis Measurements

Making SDH Analysis Measurements

Description

G.826, M.2101, M.2110 and M.2120 analysis results are provided for all relevant SDH error sources.

In addition the following results are provided:

- Cumulative error count and error ratio
- Short Term error count and error ratio
- Alarm Seconds
- Frequency and Optical Power
- Pointer values and pointer adjustment counts
- Pointer Graph. See, "Using Pointer Graph Test Function " page 95.

RESULTS		SDH		ERROR ANALYSIS	
G.826	M.2101	M.2110	M.2120		
ERROR TYPE B2 BIP					
B2 BIP ANALYSIS (G.826)					
EB	5679	ES	2		
SES	1	URS	0		
PURS	0	BBE	624		
ESR	3.571E-02	SESR	1.786E-02		
BBER	1.418E-03				
ELAPSED TIME		00d 00h 00m 56s			

STATUS:

ERROR SUMMARY	CUMULATIVE	SHORT TERM	ERROR ANALYSIS	MORE	MULTIPLE WINDOW
---------------	------------	------------	----------------	------------	-----------------

HOW TO:

- 1 Set up the receive SDH interface and payload required. See "Setting SDH Receive Interface " page 49.
- 2 If required set up the SDH transmit interface and payload. See "Setting SDH Transmit Interface " page 29.
- 3 Press **RUN/STOP** to start the measurement.
- 4 You can view the analysis results on the **RESULTS** | **SDH** | **ANALYSIS** display.

TIP:

The measurement will not be affected if you switch between the different results provided.

Making PDH Analysis Measurements

Description
Option 012 is required for PDH operation.

G.821, G.826, M.2100, M.2110 and M.2120 analysis results are provided for all relevant PDH and PDH Payload error sources. In addition the following results are provided:

- Cumulative error count and error ratio. Short Term error count and error ratio.
- Alarm Seconds
- SIG/BIT Monitor. See "Monitoring Signaling Bits " page 120.

RESULTS	PDH	ERROR ANALYSIS		
G.821	G.826	M.2100	M.2110	M.2120
FRS 140 Mb/s				
EC	0			
ES	9		4.68750%	
EFS	183		95.31250%	
SES	9		4.68750%	
UNAU	0		0.00000%	
DEG MIN	0		0.00000%	
CODE ES	N/A			
ELAPSED TIME			00d 00h 03m 12s	

STATUS:

MULTIPLE WINDOW

HOW TO:

- 1 If SDH is chosen as the interface, set up the Receive Interface and Payload required. See "Setting SDH Receive Interface " page 49. If required set up the Transmit Interface and Payload. See "Setting SDH Transmit Interface " page 29.
- 2 If PDH is chosen as the interface, set up the PDH receive interface. See "Setting PDH/DSn Receive Interface (Option 012) " page 47. If required set up the PDH transmit interface. See "Setting PDH/DSn Transmit Interface (option 012) " page 26.
- 3 Press **RUN/STOP** to start the measurement.
- 4 If SDH is chosen as the interface, you can view the analysis results on the **RESULTS** **PDH PAYLOAD** **ERROR ANALYSIS** display
 If PDH is chosen as the interface, you can view the analysis results on the **RESULTS** **PDH** **ERROR ANALYSIS** display.

Measuring Frequency

Description

The signal frequency and the amount of offset from ITU-T standard rate can be measured to give an indication of the probability of errors.

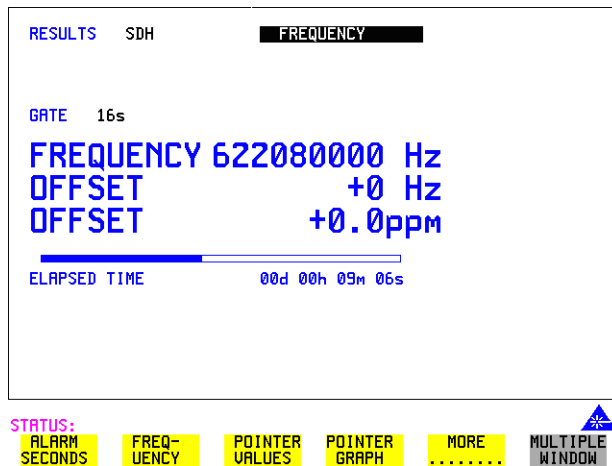

HOW TO:

- 1 Connect the signal to be measured to the IN port of the PDH/DSN RECEIVE module or the IN port of the Multirate Analyzer module (SDH electrical) or the IN port of the Optical Interface module (SDH optical).
- 2 Choose the required SIGNAL rate and LEVEL on the **PDH/DSN RECEIVE** **MAIN SETTINGS** or **SDH RECEIVE MAIN SETTINGS** display.

NOTE

1. Frequency measurement is always available even if test timing is off.
2. The result is only valid if a complete sweep of the highlighted bar has occurred since the input was applied.

Test Period

Two counter gate periods, selected in the **GATE** field are provided simultaneously, 1s and 16s. For the 16s gate period a “Fuel Gauge” indicates progress towards the next update.

Measuring Optical Power

Description

Optical power measurement can be performed on the SDH signal connected to the IN port of the Optical Interface module.

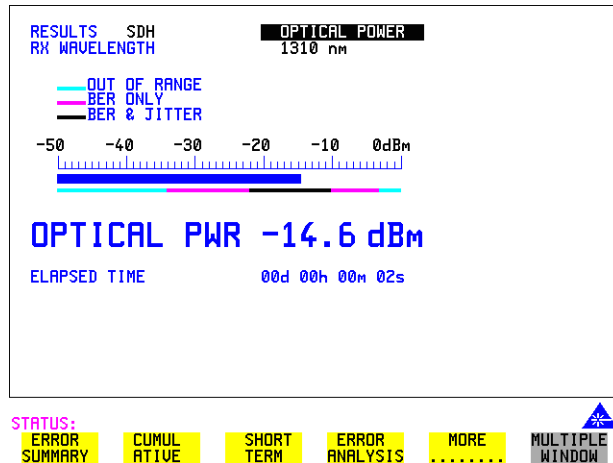

HOW TO:

- 1 Connect the SDH optical signal to the IN port of the Optical Interface module.
- 2 Choose the received input signal rate on the **RECEIVE** **SDH** display.
- 3 To view Optical Power results select **RESULTS** **SDH RESULTS**, press **MORE** twice then select **OPTICAL POWER**.

NOTE

1. Optical power measurement is always available even if test timing is off.
2. The white portion of the coloured bar shows the power range for accurate jitter measurement (only displayed if a jitter option is fitted). The green portion of the coloured bar shows the power range for accurate BER measurement.

Making Measurements

Measuring Round Trip Delay

Measuring Round Trip Delay

Description:

The time taken for voice traffic to pass through the network is very important. Excessive delay can make speech difficult to understand.

The Round Trip Delay feature of the OmniBER 718 measures the delay in a 64 kb/s timeslot.

A test pattern is transmitted in the 64 kb/s timeslot and a timer is set running. A loopback is applied to the network equipment to return the test signal. The received pattern stops the timer and the Round Trip Delay is calculated.

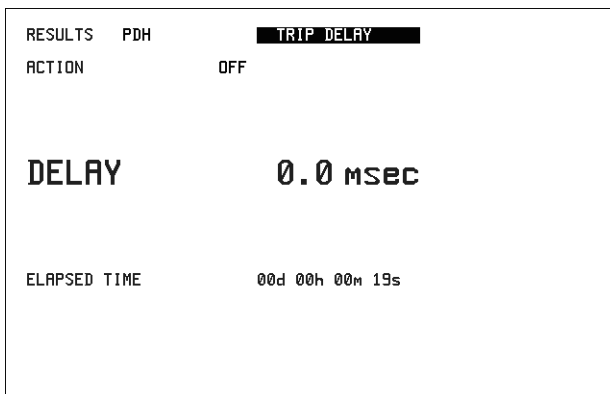

STATUS:
ERROR SUMMARY CUMULATIVE SHORT TERM ERROR ANALYSIS MORE MULTIPLE WINDOW

NOTE

You can only measure Round Trip Delay on a 64 kb/s test signal obtained from a 140 Mb/s, 34 Mb/s, 8 Mb/s or 2 Mb/s PDH/DSn interface or PDH/DSn payload signal.

HOW TO:

- 1 If measuring on an SDH interface, set up the SDH transmit and receive interfaces and payloads required. See "Setting SDH Transmit Interface " page 29 and "Setting SDH Receive Interface" page 49.
- 2 If measuring on a PDH interface, set up the PDH transmit and receive interfaces and payloads required. See "Setting PDH/DSn Transmit Interface (option 012)" page 26 and "Setting PDH/DSn Receive Interface (Option 012)" page 47.
- 3 Connect a loopback to the network equipment.
- 4 Choose ACTION **ON** to start the measurement.

Making Measurements

Measuring Round Trip Delay

If measuring on an SDH interface, the results are available on the **RESULTS** **PDH PAYLOAD** display.

If measuring on a PDH interface, the results are available on the **RESULTS** **PDH** display.

The Round Trip delay measurement range is up to 2 seconds. The resolution varies with the received interface signal rate:

2 Mb/s	1 microsecond
8, 34, 140 Mb/s	10 microseconds
STM-0, STM-1	0.5 milliseconds
STM-4, STM-16	0.5 milliseconds

Monitoring Signaling Bits

Description

The OmniBER 718 receiver can be used to monitor the state of signaling bits in received 2 Mb/s signals with timeslot-16 CAS multiframing (PCM30 or PCM30CRC) and DS1 structured signals.

2.048 Mb/s Results

For 2 Mb/s signals with timeslot-16 CAS multiframing a table showing the values of A,B,C,D signaling bits in all 30 channels is given.

DS1 Results

D4 and SLC-96 payloads

A table simultaneously showing the state of the A and B signaling bits in the 6th and 12th frames of a superframe is given. Each frame contains 24 timeslots. In SLC-96 mode A and B choices are 0, 1 or alternating. If you set bit A or B to alternate, the displayed bit changes to an A, to indicate that the bit is alternating from 1 to 0. The same signaling is transmitted in all channels.

ESF Payloads

A table simultaneously showing the state of the A, B, C and D signaling bits in the 6th, 12th, 18th and 24th frames of a superframe is given. Each frame contains 24 timeslots.

```
RESULTS  DS1 PAYLOAD  SIG/BIT MONITOR

DS1 ESF ABCD BITS

TS  ABCD  TS  ABCD  TS  ABCD  TS  ABCD
1   1100  7   1111  13  1111  19  1111
2   1111  8   1111  14  1111  20  1111
3   1111  9   1111  15  1111  21  1111
4   1111  10  1111  16  1111  22  1111
5   1111  11  1111  17  1111  23  1111
6   1111  12  1111  18  1111  24  1111
```

STATUS:
ERROR SUMMARY CUMULATIVE SHORT TERM ERROR ANALYSIS MORE MULTIPLE WINDOW

Measuring Service Disruption Time

Description:

Protection switching ensures that data integrity is maintained and revenue protected when equipment failure occurs. The speed of operation of the protection switch can be measured.

The time interval between pattern sync loss and pattern sync gain is a measure of the disruption of service due to protection switching. For information on measuring service disruption on ATM refer to "ATM Service Disruption " page 180 and for POS refer to "POS Service Disruption" page 215.

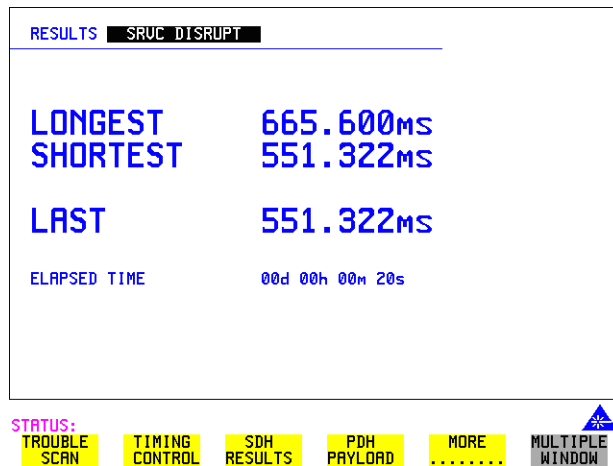

Service Disruption is chosen on the **RESULTS** display except for the following configuration:

- If you choose a PDH or SDH/SONET interface and an ANSI (DS1, DS3) framed, unstructured payload you must select Service Disruption on the **TRANSMIT** and **RECEIVE TEST FUNCTION** displays.

Making Measurements

Measuring Service Disruption Time

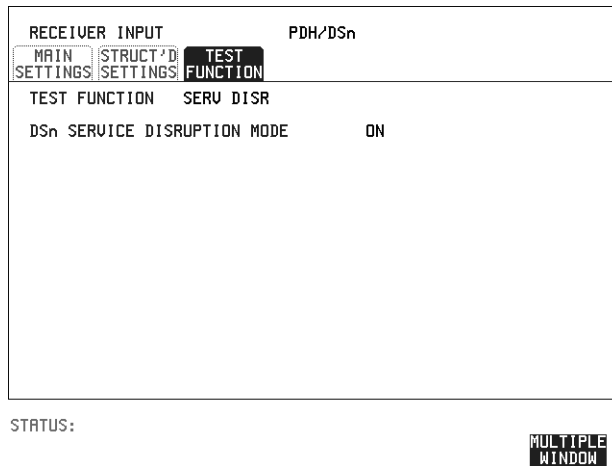

NOTE

At DS1 and DS3, Service Disruption results are only available for Unstructured payloads.

Error Burst Definition

Error bursts start and finish with an error. Bursts of less than 10 us are ignored. Bursts are assumed to have completed when >200 ms elapses without any errors being received.

The longest burst detected is 2 seconds.

Accuracy: <= 50us for bulk filled PDH/T-Carrier tributary test signals.

NOTE

Note To measure Service Disruption your instrument must have a PDH/DSn module fitted as the measurement takes place within the PDH/DSn module.

HOW TO:

- 1 If interfacing at SDH set up the SDH transmit and receive interfaces and payloads required. See "Setting SDH Transmit Interface " page 29 and "Setting SDH Receive Interface " page 49.
- 2 If interfacing at PDH/DSn set up the PDH/DSn transmit and receive interfaces and payloads as required. See "Setting PDH/DSn Transmit Interface (option 012) " page 26 and "Setting PDH/DSn Receive Interface (Option 012) " page 47.

Making Measurements

Measuring Service Disruption Time

- 3 If you choose a DS1 or DS3 framed unstructured payload, choose **SERVICE DISRUPT** on the **TRANSMIT** and **RECEIVE** **TEST FUNCTION** displays.
- 4 Press **RUN/STOP** to start the measurement.
- 5 Invoke the protection switch.
- 6 View the results on the **RESULTS** **SRVC DISRUPT** display.

Results Displayed

LONGEST - Longest burst of errors during measurement.

SHORTEST - Shortest burst of errors during measurement.

LAST - Length of last burst of errors detected during measurement.

Resolution: 1us

Performing an SDH Tributary Scan

Description

Verifying an ADM Installation

An important part of the ADM installation process is the verification of path routing through the ADM (or Digital Cross Connect). In order to verify the routing of VC-n paths which are terminated by the network element, the mapped payload, dropped to a PDH tributary port, must be looped back at the digital distribution frame and mapped into the VC-n at the PDH tributary insert port. VC-n paths which are not terminated must be looped back at the STM-n level. Since an STM-1 contains 63 VC-12's and a STM-4 contains 252 VC-12's, manually checking each path is time consuming and laborious.

Using the OmniBER 718 Tributary Scan feature the installation of ADM's can be automated and any Bit errors or Pattern Loss flagged on the RESULTS display.

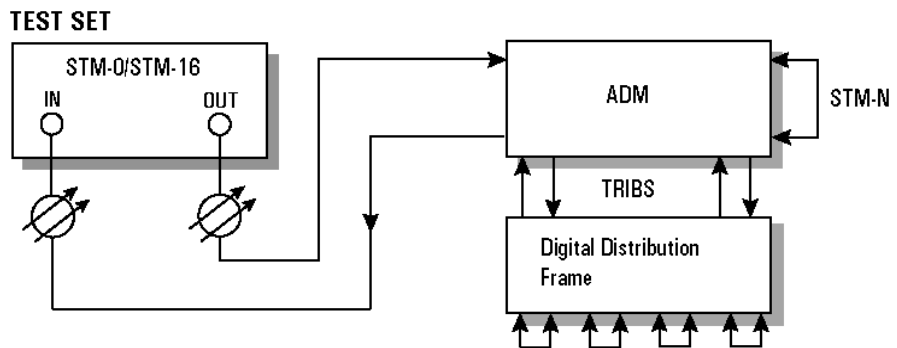

Making Measurements

Performing an SDH Tributary Scan

Tributary Scan tests each tributary for error free operation and no occurrence of Pattern Loss. A failure is indicated by highlighting the tributary in which the failure occurred. The **TRANSMIT** **SDH** **MAIN SETTINGS** mapping setup determines the tributary structure. The OmniBER 718 will configure the Transmitter to the Receiver and the PATTERN is forced to the payload it will fill.

The SDH Tributary Scan display can be logged to the chosen logging device. See "Logging on Demand " page 261

TRANSMITTER OUTPUT		SDH		
MAIN SETTINGS	STRUCT'D PAYLOAD	JITTER	TEST FUNCTION	OVERHEAD SETUP
TEST FUNCTION	TRIB SCAN	STOP		
BIT ERROR THRESHOLD	>= 1E-3			
TEST TIMING	SINGLE	10 SECS		
SEE RESULTS PAGE FOR TRIBUTARY SCAN RESULTS				

STATUS:

**MULTIPLE
WINDOW**

HOW TO:

- 1 Set up the transmit and receive SDH interfaces and payload as required. See "Setting SDH Transmit Interface " page 29 and "Setting SDH Receive Interface " page 49.
- 2 Choose the required BIT ERROR THRESHOLD.
This determines the error rate above which a failure is declared.
- 3 Choose the required TEST TIMING.
The value you choose is the test time for each individual tributary and not the total test time.
For example, 63 TU-12 tributaries in an AU-4 - the time taken to complete the Tributary Scan will be 63 X TEST TIMING choice.
- 4 See next page.

Making Measurements

Performing an SDH Tributary Scan

- 5 The Tributary Scan results can be viewed on the **RESULTS** **SDH TRIBSCAN** display.
- The Scan can be started on the **TRANSMIT** **SDH TEST FUNCTION** display or the **RESULTS** display by choosing **START**.
- If the Scan is started on the **TRANSMIT** **SDH TEST FUNCTION** display, the OmniBER 718 changes to the **RESULTS** display.
- If a full-bandwidth concatenated payload is selected (e.g. an VC-4-16c within an STM-16), then Tributary Scan is disabled.

NOTE

The keyboard is locked during tributary scan.

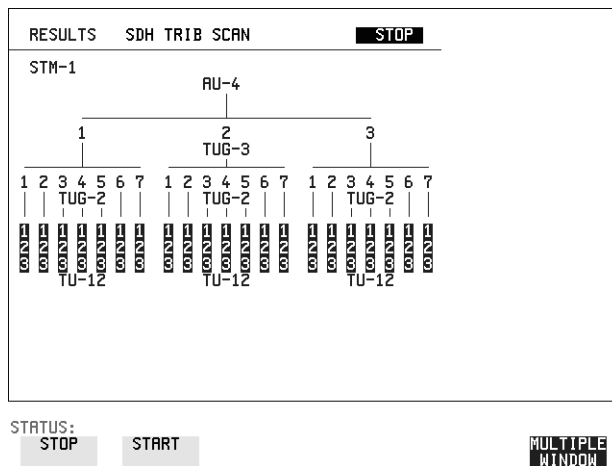

Performing an SDH Alarm Scan

Description

This test can be performed In-Service without disturbing live traffic. SDH Alarm Scan tests each channel for alarm free operation and identifies and indicates any Unequipped channels. You can configure the Scan to check for the occurrence of any Path layer BIP errors above a chosen threshold. The channel in which an alarm occurred is highlighted if any of the following alarms occur:
 AU-LOP, HP-RDI, AU-AIS, H4 Loss of Multiframe,
 TU-AIS, LP-RDI, TU-LOP

The SDH Alarm Scan display can be logged to the chosen logging device. See "Logging on Demand " page 261.

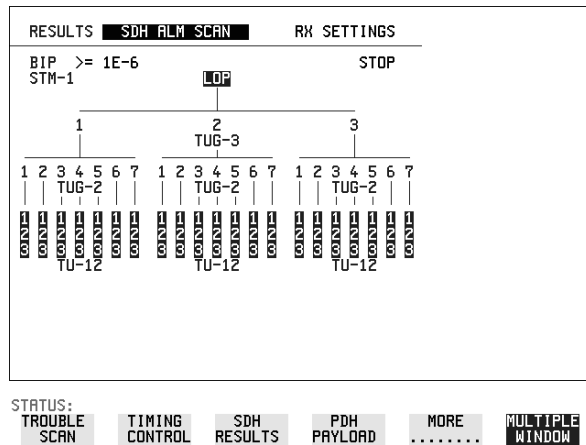

HOW TO:

- 1 Set up the receive SDH interface and payload as required. See "Setting SDH Receive Interface" page 49.
- 2 Choose **SDH ALM SCAN** on the **RESULTS** display.
- 3 Choose AUTO or RX SETTINGS.
 RX SETTINGS: The scan checks the structure set on the **RECEIVE SDH** display.
 AUTO: The scan checks the structure being received. This can be particularly useful when receiving mixed payloads.
- 4 Choose the BIP error threshold.
- 5 Choose **START** to start the Alarm Scan.

Making Measurements
Performing a PDH/DSn Alarm Scan

Performing a PDH/DSn Alarm Scan

Description

PDH Alarm Scan tests each channel for the following alarms:

- Frame Loss
- RAI
- AIS

The channel in which an alarm occurs is highlighted.

RESULTS	DSn ALM SCAN							OFF
DS3	INTERFACE							
DS2	1	2	3	4	5	6	7	
DS1	1 2 3 4	1 2 3 4	1 2 3 4	1 2 3 4	1 2 3 4	1 2 3 4	1 2 3 4	

STATUS:
TROUBLE SCAN TIMING CONTROL DSn RESULTS DSn ALM SCAN MORE MULTIPLE WINDOW

HOW TO:

- 1 Set up the receive PDH interface as required. See “Setting PDH/DSn Receive Interface (Option 012)” page 47.
- 2 Choose **ON** to start the Alarm Scan.

Measuring Jitter

*Description:
Option 200 is
required for Jitter
measurements.*

Jitter and error measurements are made simultaneously when a jitter option is fitted. Jitter measurements are also available when ATM is selected as a payload.

Cumulative and Short Term results of Jitter Amplitude and Jitter Hits are provided on the **RESULTS** **JITTER** display.

Graph and Text results for Jitter Transfer and Jitter Tolerance are also provided.

**Jitter
Measurement
Filters**

LP, HP1 and HP2 filters to ITU-T O.171 (PDH) and O.172 (SDH).

Bit Rate (kb/s)	HP1 (Hz)	HP2 (kHz)	LP (kHz)	HP rms (kHz)
1.544	10	8	40	12
2048	20	18	100	12
8448	20	80	400	12
34368	100	10	800	12
44736	10	30	400	12
51840	100	20	400	12
139264	200	20	3500	12
155520	500	65	1300	12
622080	1000	250	5000	12
2488320	5000	1000	20000	12

Please note that the instrument measurement bandwidth varies depending on the Receiver Range selected (i.e. the bandwidth is reduced when not on the 1.6 UI range). If you change the Receiver Range selection check the Filter Values displayed at the bottom right of the display meet you measurement requirements.

rms jitter measurements settling time

If you select a PDH/DSn receiver interface and choose a O.172 /GR-499 Filter on the Receiver Input, Jitter page, please allow approximately 20 seconds settling time before performing a measurement.

Making Measurements

Measuring Jitter

NOTE

To obtain optimum performance while measuring jitter on optical signals ensure the signal optical power level is within the measurement window. See “Measuring Optical Power” page 117.

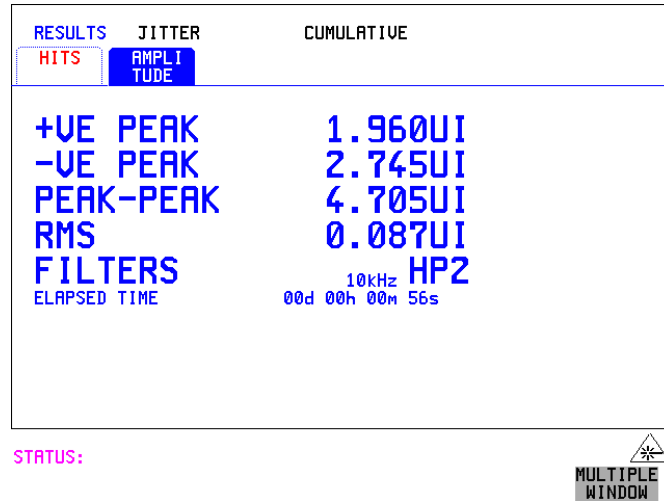

HOW TO:

- 1 If measuring Jitter on a PDH signal, set up the receive PDH interface and the receive Jitter interface. See “Setting PDH/DSn Receive Interface (Option 012)” page 47 and “Setting Jitter Receive Interface” page 50.
- 2 If measuring jitter on an SDH Optical signal, check on the **RESULTS** **SDH RESULTS** **OPTICAL POWER** display that the measured optical power level falls within the white portion of the coloured bar. This ensures the accuracy of the Jitter results.
- 3 If measuring Jitter on an SDH signal, set up the receive SDH interface and the receive Jitter interface. See “Setting SDH Receive Interface” page 49 and “Setting Jitter Receive Interface” page 50.
- 4 If performing a Jitter Tolerance measurement, see "Measuring Jitter Tolerance " page 137.
If performing a Jitter Transfer measurement, see "Measuring Jitter Transfer " page 142.
- 5 Press **RUN/STOP** to start the measurement.
- 6 You can view the Jitter hits and Amplitude results on the **RESULTS** **JITTER** display.

Measuring Extended Jitter

*Description:
 Option 200 is
 required for Jitter
 measurements.*

Extended Jitter measurements are made at the upper end of the standard wander frequency range and the lower end of the standard jitter frequency range.

When **EXTENDED** is chosen (on the Receiver Input Jitter page) Jitter results are provided. Cumulative and Short Term results of Jitter Amplitude and Jitter Hits are provided on the **RESULTS** **JITTER** display. The following Table gives the Extended range receiver measurement bandwidth.

Bit Rate (kb/s)	Range	Jitter measurement bandwidth*			
		F _L (Hz) lower 3dB point**	F _{MIN} (Hz)	F _{MAX} (kHz)	F _U (kHz) upper 3dB point
1544	256	0.15	1	0.2	0.25
2048	256	0.15	1	0.2	0.25
8448	256	0.15	1	0.2	0.625
34368	256	0.15	1	2	2.5
44736	256	0.15	1	5	6.25
51840	64	0.15	1	20	25
139264	256	0.15	1	5	6.25
155520	64	0.15	1	20	25
622080	256	0.15	1	20	25
2488320	1024	0.15	1	20	25

* The measurement accuracy is specified between F_{MIN} and F_{MAX} only.

** Nominal value.

Making Measurements

Measuring Extended Jitter

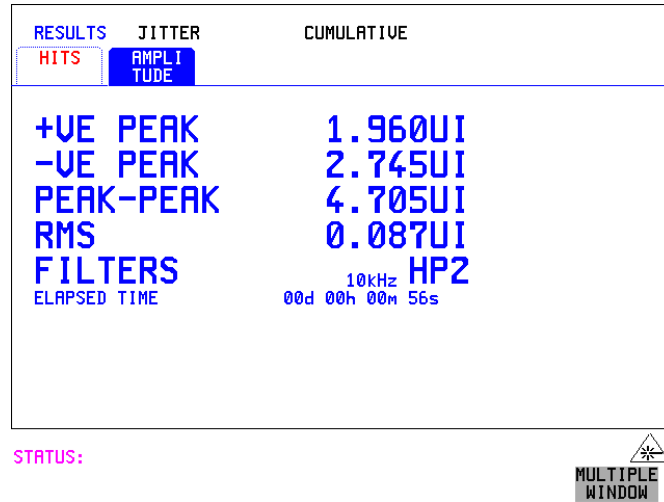

HOW TO:

- 1 If measuring Extended jitter on a PDH signal, set up the receive PDH interface and the receive Jitter interface. See “Setting PDH/DSn Receive Interface (Option 012)” page 47 and “Setting Extended Jitter Receive Interface” page 51.
- 2 If measuring Extended jitter on an SDH Optical signal, check on the **RESULTS** **SDH RESULTS** **OPTICAL POWER** display that the measured optical power level falls within the white portion of the coloured bar. This ensures the accuracy of the Jitter results.
- 3 If measuring Extended jitter on an SDH signal, set up the receive SDH interface and the receive Jitter interface. See “Setting SDH Receive Interface” page 49 and “Setting Extended Jitter Receive Interface” page 51.
- 4 Press **RUN/STOP** to start the measurement.

Measuring Wander

Description:
Option 200 is required for Jitter measurement.

Wander is defined as the long- term variations of the significant instants of a digital signal from their ideal positions in time, where long-term implies phase oscillations of frequency less than or equal to a demarcation point that is specified for each interface rate. Refer to ANSI T1.102 for the demarcation frequencies for each digital signal.

Accurate Wander measurements require a Wander reference derived from a master timing external source. Connect your external timing source to the appropriate port on the instrument clock module. Wander results are displayed in UI or nanoseconds. Jitter Amplitude and Jitter Hits results are also available.

Problems may arise due to wrongly configured equipment running on internal clocks or at the junction of different operator's network equipment. Since the timing sources may operate at slightly different frequencies and exhibit long term frequency drift, phase difference (Wander) may occur between the incoming data and the network equipment. This causes "Bit Slips" in the network equipment buffers and results in frames being repeated or deleted thus reducing the efficiency of data transfer.

When wander is measured at 2 Mb/s or DS1, Estimated Bit and Frame slips are calculated and a Bar Graph shows the cumulative Wander over the measurement period.

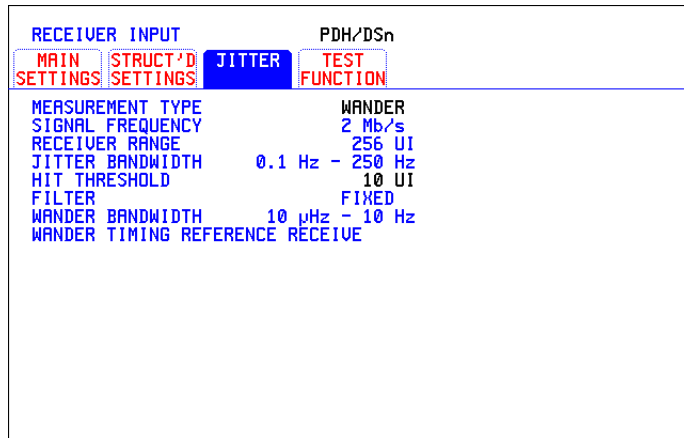

STATUS:

MULTIPLE
WINDOW

Making Measurements

Measuring Wander

HOW TO:

Make the Measurement

1 PDH Operation Wander Reference:

Select the **TRANSMIT** **PDH/DSn** **MAIN SETTINGS** display, and set the CLOCK field to **EXTERNAL**. Choose the CLOCK SOURCE required from the menu provided (i.e. MTS 2M CLOCK/DATA, MTS 64k CLOCK, BITS 1.5Mb/s and 10MHz REF). Connect your external timing source to the appropriate port on the instrument clock module. See "Setting PDH/DSn Transmit Interface (option 012)" page 26.

2 SDH Operation Wander Reference

Select the **TRANSMIT** **SDH** **MAIN SETTINGS** display, and set the CLOCK field to **EXTERNAL**. Choose the CLOCK SOURCE required from the menu provided (i.e. MTS 2M CLOCK/DATA, MTS 64k CLOCK, BITS 1.5Mb/s and 10MHz REF). Connect your external timing source to the appropriate port on the instrument clock module. See, "Setting SDH Transmit Interface" page 29.

- 3 If measuring wander at a PDH rate, set up the PDH receive interface. See, "Setting PDH/DSn Receive Interface (Option 012)" page 47.
- 4 If measuring wander on an SDH Optical signal, check on the **RESULTS** **SDH RESULTS** **OPTICAL POWER** display that the measured optical power level falls within the white portion of the coloured bar. This ensures the accuracy of the Wander results.
- 5 If measuring wander at an SDH rate set up the SDH receive interface. See, "Setting SDH Receive Interface" page 49.
- 6 Choose MEASUREMENT TYPE **WANDER**, as shown in the display on previous page.
- 7 Choose the WANDER HIT THRESHOLD level - if the received wander exceeds the value chosen a wander hit is recorded.
- 8 Press **RUN/STOP** to start the measurement.

Making Measurements

Measuring Wander

HOW TO:

View the Results

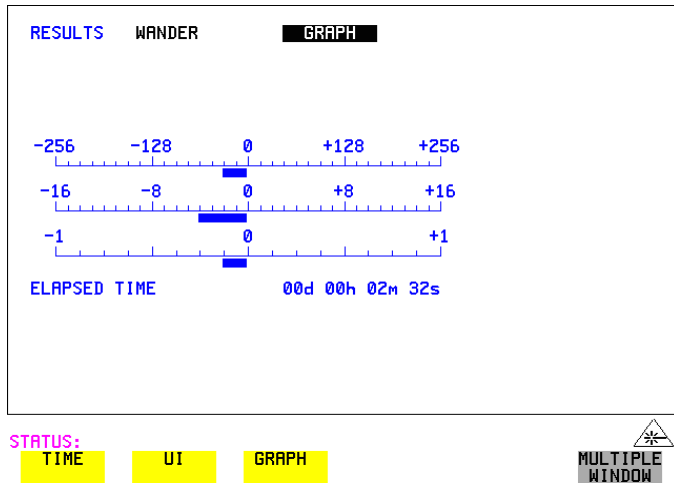

- 9 Choose **WANDER** on the **RESULTS** display and choose the display units required:
 - TIME displays the wander results in nanoseconds.
 - UI displays the wander results in Unit Intervals.
 - If you are measuring wander at 2 Mb/s or DS1 Estimated Bit slips and Estimated Frame slip results are provided and a **GRAPH** choice is added to the menu.
- If **GRAPH** is chosen the cumulative wander results are displayed in graphical form. The Graphs are additive and in the example shown the Wander is -36.125 BITS. Graph is only available when a DS1 or 2 Mb/s signal is selected.

NOTE

Estimated Bit Slips signify the slippage from the start of the measurement. One Estimated Frame Slip corresponds to 256 Bit Slips. Implied Frequency Offset is calculated from the Wander results.

Refer to the following page for displays giving examples of Time and UI wander results.

Making Measurements

Measuring Wander

Wander Time Results

RESULTS	WANDER	TIME
TIME INTERVAL ERROR	-10028265	nsec
+VE PEAK	0	nsec
-VE PEAK	10028265	nsec
PEAK-PEAK	10028265	nsec
PEAK-PEAK (15 MIN)	nsec
PEAK-PEAK (24 HOURS)	nsec
IMP FREQUENCY OFFSET	-65.975	ppm
EST BIT SLIPS	-15483	
EST FRAME SLIPS	-80	
ELAPSED TIME	00d 00h 02m 32s	

STATUS:

TIME

UI

GRAPH

MULTIPLE
WINDOW

Wander UI Results

RESULTS	WANDER	UI
TIME INTERVAL ERROR	-15483.6411	UI
+VE PEAK	0.0000	UI
-VE PEAK	15483.6411	UI
PEAK-PEAK	15483.6411	UI
PEAK-PEAK (15 MIN)	UI
PEAK-PEAK (24 HOURS)	UI
IMP FREQUENCY OFFSET	-65.975	ppm
EST BIT SLIPS	-15483	
EST FRAME SLIPS	-80	
ELAPSED TIME	00d 00h 02m 32s	

STATUS:

TIME

UI

GRAPH

MULTIPLE
WINDOW

Measuring Jitter Tolerance

Description:
Option 200 is required for Jitter measurement and 012 for PDH operation.

The jitter auto tolerance feature provides jitter tolerance measurements within the relevant ITU-T mask, G.823 low and high Q systems are provided for PDH (2, 8, 34, 140 Mb/s).

DS1 and DS3 masks are taken from ITU-T G.824 and Bellcore GR.499, Category 1 and Category 2 equipment.

For SDH the masks provided are those specified in ITU-T G.958, type A or B, and in ITU-T G.825. SONET masks are taken from GR-253. The jitter auto tolerance feature is also available when ATM is selected as a payload.

PDH User Selectable Masks

Line Rate	G.823	G.823 High Q	G.823 Low Q	G.824	GR.499 CAT 1	GR.499 CAT 2
2 Mb/s		√	√			
8 Mb/s		√	√			
34 Mb/s	√					
140 Mb/s	√					
DS1				√	√	√
DS3				√	√	√

SDH/SONET User Selectable Masks

Line Rate	GR.253	G.825	G.958 Type A	G.958 Type B
STM-0	√			
STM-1	√	√	√	√
STM-4	√	√	√	√
STM-16	√	√	√	√

Making Measurements

Measuring Jitter Tolerance

Jitter is generated at a range of frequencies within the mask and an error measurement is made. If no errors occur (PASS), the jitter amplitude at that frequency point is increased until errors do occur (FAIL) or the maximum jitter amplitude is reached. The highest jitter amplitude at which PASS occurs is plotted on the graph as the Jitter Tolerance for that jitter frequency.

User-Programmable Masks

There are 5 user programmable masks provided allowing you to create, edit and title up to 5 jitter masks. Please refer to “To Generate a New Jitter Mask” on page 317 and “To change the parameters of a User Defined Jitter Mask” on page 319 for instructions on how to generate or edit a user programmable mask.

TIP:

The transmitter and receiver can be set to different rates to allow testing across multiplexers, for example transmitter set to STM-1 with embedded 34 Mb/s and receiver set to 34 Mb/s.

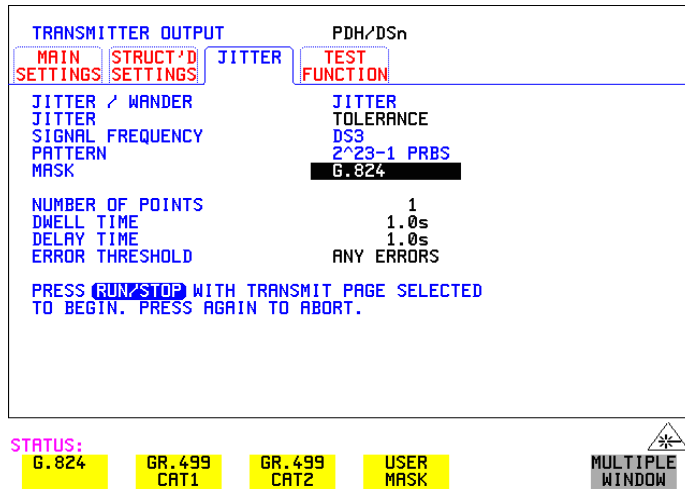

HOW TO:

Make the Measurement

PDH/DSn Interface

- 1 If you are performing jitter tolerance on a PDH/DSn signal, set up the PDH/DSn transmit and receive interfaces, including the required test PATTERN. See “Setting PDH/DSn Transmit Interface (option 012)” page 26 and “Setting PDH/DSn Receive Interface (Option 012)” page 47.

Making Measurements

Measuring Jitter Tolerance

- If you have chosen a PDH/DSn interface now select the JITTER page and select AUTO TOLERANCE and a MASK (see previous display). Proceed to step 6.

SDH Interface

- If you are performing jitter tolerance on an SDH Optical signal, check on the **RESULTS** **SDH RESULTS** **OPTICAL POWER** display that the measured optical power level falls within the white portion of the coloured bar. This ensures the accuracy of the Jitter results.
- If you are performing jitter tolerance on the SDH signal, set up the SDH transmit and receive interfaces, including the required test PATTERN. See “Setting SDH Transmit Interface” page 29 and “Setting SDH Receive Interface” page 49.

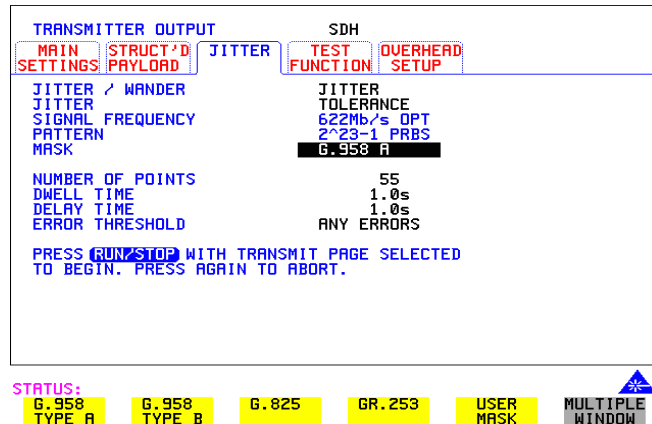

- If you have chosen an SDH interface now select the JITTER page and select AUTO TOLERANCE and a MASK (see display above).

Steps common to PDH/DSn and SDH operation

- Choose the NUMBER OF POINTS at which jitter is transmitted (3 to 55)
- Choose the DWELL TIME - the time jitter is generated at each jitter frequency point (0.1 to 99.9 seconds).
- Choose the DELAY TIME - the time delay between the jitter frequency/amplitude being applied and the error measurement being made. This allows the network equipment to settle as jitter frequency is changed. (0.1 to 99.9 seconds).

Making Measurements

Measuring Jitter Tolerance

- Choose the **ERROR THRESHOLD**.
If **ANY ERRORS** is chosen, any BIP or BIT error will result in a **FAIL**.
If **BIT ERRORS** is chosen, choose a value between 1 and 1,000,000 to determine the bit error threshold for the jitter tolerance **PASS/FAIL** decision.
BER>= shows the bit error ratio calculated from the bit error threshold choice and the dwell time choice.
- Press **RUN/STOP** to start the jitter auto tolerance measurement.
The measurements progress can be monitored on the **TRANSMIT** display. At the end of the test the results can be viewed on the **TRANSMIT** or **RESULTS** displays. The **TRANSMIT** display is cleared when **TRANSMIT** is pressed but the results remain on the **RESULTS** display until the next jitter tolerance measurement is made.

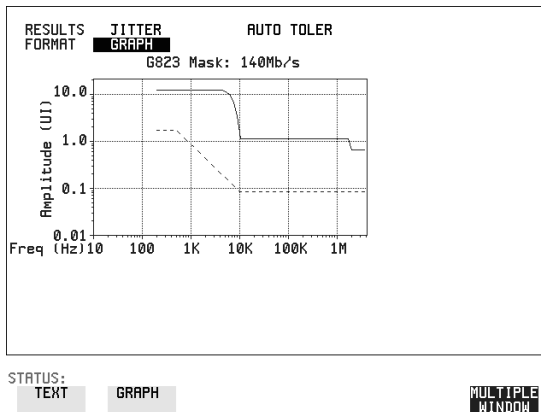

HOW TO:

View the Results

- Choose the results **FORMAT**.
If **GRAPH** is chosen, a plot of the jitter tolerance results against the ITU-T mask is displayed.
If **TEXT** is chosen, the results from which the graph is constructed are displayed, Point number, Frequency, Mask amplitude, Tolerance, Result.

Making Measurements

Measuring Jitter Tolerance

If applicable, points 13 through 55 can be viewed on pages 2 through 5.

RESULTS	JITTER	AUTO TOLER		
FORMAT	TENT	PAGE		
G823 Mask: 34Mb/s				
Point	Frequency	Mask(UI)	Tol(UI)	Result
1	100.0	1.50	>10.00	PASS
2	118	1.50	>10.00	PASS
3	139	1.50	>10.00	PASS
4	165	1.50	>10.00	PASS
5	195	1.50	>10.00	PASS
6	230	1.50	>10.00	PASS
7	271	1.50	>10.00	PASS
8	321	1.50	>10.00	PASS
9	379	1.50	>10.00	PASS
10	447	1.50	>10.00	PASS
11	528	1.50	>10.00	PASS
12	624	1.50	>10.00	PASS

STATUS:

1

2

3

4

5

MULTIPLE WINDOW

If you wish to log the jitter tolerance results to a printer, see “Logging Jitter Tolerance Results” page 264.

Measuring Jitter Transfer

Description:
Option 200 is required for Jitter measurement and 012 for PDH operation.

Perform vital jitter transfer (gain) measurements using the OmniBER 718. With the OmniBER 718 you can perform Jitter transfer measurements at each of the four PDH rates 2, 8, 34, 140 Mb/s, plus DS1, DS3 and also STM-0, STM-1, STM-4 and STM-16. Jitter Transfer measurements are also available when ATM is selected as a payload.

Jitter transfer defines the ratio of output jitter amplitude to input jitter amplitude versus jitter frequency for a given bit rate. In network equipment some of the jitter present at the input port of a regenerator will be transmitted to the output port. On networks with cascaded equipment on long trunk routes it is important to limit jitter transfer.

The jitter generator provides the stimulus for the jitter transfer measurement. Automatic band filtering is used in the jitter receiver this provides selection and measurement of the relevant jitter components to provide accurate and repeatable results.

The jitter transfer results are presented in graphical and tabular form. Graphical results are plotted as Gain V Frequency.

The relevant Pass Mask for PDH or SDH is also displayed on the graph. Please refer to the OmniBER 718 Specifications book provided with your instrument for detailed information on Jitter Transfer input and pass masks.

The OmniBER is capable of generating input jitter frequencies up to 20MHz. For ITU-T G.958 Type B 'Jitter Transfer' testing at STM-4 and STM-16, we recommend that a maximum input frequency of 3MHz is used. This will ensure that the transfer measurement remains within the dynamic range of the receiver.

NOTE

1. The Transmitter and Receiver must be set to the same interface rate.
2. There is no ITU-T Pass Mask for 140 Mb/s.

HOW TO:

Achieve the required accuracy:

- 1 The OmniBER 718 must be connected back to back in order to perform a calibration cycle before making a Jitter Transfer measurement (see figure on next page). Use an optical attenuator to keep optical power at optimum level if you are performing tests on optical signals.

Making Measurements

Measuring Jitter Transfer

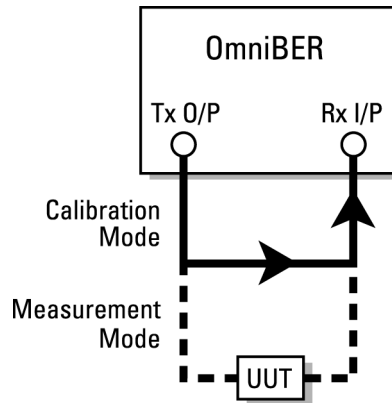

- 2 The OmniBER 718 must have been switched on for 1 hour before starting a calibration cycle.
- 3 The climatic conditions must remain stable from switch-on to end of measurement.
- 4 The Jitter Transfer measurement must be started within 10 minutes of completion of the Calibration.
- 5 If maximum Delay time, maximum Dwell time and maximum number of Points is selected, the accuracy specification cannot be guaranteed as the time from start of calibration to end of measurement (test period) will be approximately two hours. It is recommended that the maximum test period does not exceed 90 minutes.
Test Period = (Delay Time + Dwell Time + 5 Seconds) X Number of Points X 2 (Calibration + Measurement).

NOTE

For best results a Dwell Time of 20 seconds and Delay Time of 10 seconds are recommended.

Making Measurements

Measuring Jitter Transfer

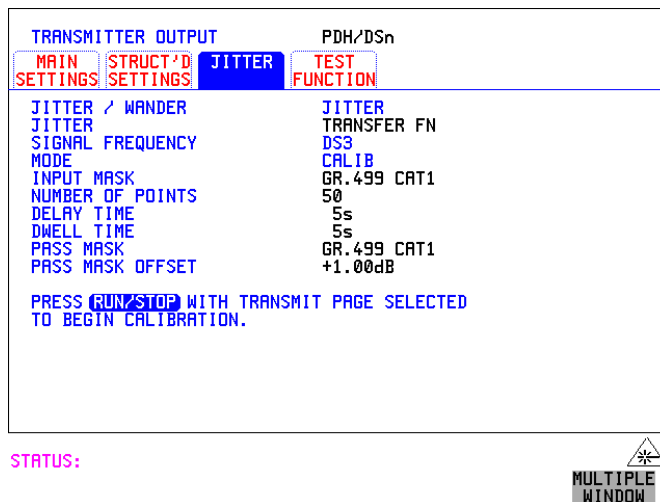

HOW TO:

Perform Jitter Transfer Calibration

NOTE

If a PDH/DSn interface is selected the CALIBRATION should always be carried out with LEVEL **TERMINATE** selected on the **RECEIVE MAIN SETTINGS** display.

- 1 If PDH Jitter Transfer is required, set up the PDH transmit and receive interfaces, the receive jitter interface and connect PDH IN to PDH OUT. See “Setting PDH/DSn Transmit Interface (option 012)” page 26, “Setting PDH/DSn Receive Interface (Option 012)” page 47 and “Setting Jitter Receive Interface” page 50.
- 2 If you are performing jitter transfer on an SDH Optical signal, check on the **RESULTS SDH RESULTS OPTICAL POWER** display that the measured optical power level falls within the white portion of the coloured bar. This ensures the accuracy of the Jitter results.
- 3 If STM-0, STM-1, STM-4 or STM-16 Optical Jitter Transfer is required, set up the SDH transmit and receive interfaces, the receive jitter interface and connect the OUT port of the Optical module to the IN port of the Optical module. See “Setting SDH Transmit Interface” page 29, “Setting SDH Receive Interface” page 49 and “Setting Jitter Receive Interface” page 50.

CAUTION

If STM-0/1/4/16 SDH Jitter Transfer is required, a 15 dB attenuator must be connected between the IN and OUT ports of the Optical module.

Making Measurements

Measuring Jitter Transfer

4 If you wish to measure STM-0 or STM-1 electrical jitter transfer, set up the SDH transmit/ receive interfaces and the receive jitter interface and connect IN port to OUT port on the SDH module. See “Setting SDH Transmit Interface” page 29, “Setting SDH Receive Interface” page 49 and “Setting Jitter Receive Interface” page 50.

5 Choose JITTER **TRANSFER FUNCTION** on the **TRANSMIT** **JITTER** display.

6 Choose the INPUT MASK.

SDH operation

If measuring SDH jitter transfer, the ITU-T G.958 mask can be Type A or Type B and the Bellcore GR-253 mask can be High or Low. You can also select from 1 of 5 user programmable jitter masks see (**USER**) paragraph below.

GR-253 Low masks cover the lower frequency band.

GR-253 High masks cover the upper frequency band.

PDH/DSn operation

If measuring PDH jitter transfer at 2 Mb/s or 8 Mb/s a Q Factor choice is provided (G.823, High Q and G.823 Low Q). Your Q Factor choice should match the network equipment regenerator Q Factor.

At 34 and 140 Mb/s a G.823 jitter transfer input mask is offered while at DS1 and DS3 G.824 and GR.499 Cat1 and GR.499 Cat2 are provided.

If **USER** is chosen, choose the mask jitter frequencies, F1, F2, F3 and F4, and mask jitter amplitudes A1 and A2, see “To change the parameters of a User-defined jitter mask” page 319 for instructions on how to change the parameters of a user mask and “To Generate a New Jitter Mask” on page 317.

7 Choose the NUMBER OF POINTS at which jitter is transmitted (1 to 55)

8 Choose the DELAY TIME - the time delay between the jitter frequency/ amplitude being applied and the error measurement being made. This allows the network equipment to settle as jitter frequency is changed (5 to 30 seconds).

9 Choose the DWELL TIME - the Dwell Time is the test period spent at each amplitude/frequency point (5 to 30 seconds). The result recorded is the maximum peak-to-peak jitter detected during the Dwell Time test period.

10 Select a PASS MASK if a choice is given.

Pass Mask Offset

11 An offset in the range -2.00 dB to +2.00 dB in steps of 0.01 dB can be added to the selected Pass Mask. Select PASS MASK OFFSET and use the edit keys to select an offset. Select **END EDIT** when finished selecting an offset.

Making Measurements

Measuring Jitter Transfer

- 12 With MODE set to **CALIB** press **RUN/STOP** to start the calibration. The Jitter Transfer display is replaced by an information display for the duration of the Calibration. A bar graph showing the progress of the calibration will appear on the display. When the Calibration is complete, the display will revert to the **TRANSMIT** **JITTER** display.

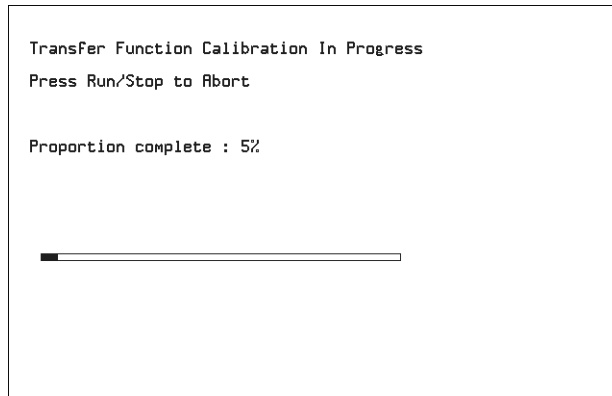

STATUS: Jitter transfer Function in progress

**MULTIPLE
WINDOW**

HOW TO:

Start the Jitter Transfer Measurement

NOTE

The Jitter Transfer measurement must be started within 10 minutes of the completion of calibration.

- 1 After the CALIBRATION is completed, remove the back to back connection from the PDH or SDH or optical interfaces. If the measurement is to be made at a network equipment monitor point, choose **MONITOR** on the PDH **RECEIVE** **MAIN SETTINGS** display before making the jitter transfer measurement.
- 2 Choose MODE **MEASURE** on the **TRANSMIT** **JITTER** display and press **RUN/STOP**. The measurement's progress can be monitored on the **TRANSMIT** display.

HOW TO:

View the Results

- 1 Select **RESULTS**, **JITTER** and **TRANSFER FN**, then choose the results FORMAT.

Making Measurements

Measuring Jitter Transfer

If **GRAPH** is chosen, a plot of the jitter transfer results against the ITU-T mask is displayed.

If **TEXT** is chosen, the results from which the graph is constructed are displayed:
 Point number, Frequency, Mask amplitude (dB), Jitter Gain (dB), Result.
 If applicable, points 13 through 55 can be viewed on pages 2 through 5.

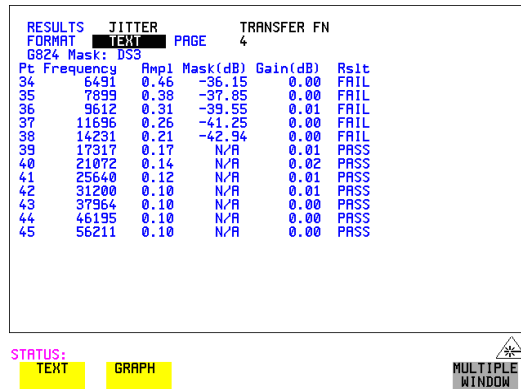

2 If **GRAPH** is chosen, choose the SCALE required.

WIDE provides a vertical axis range of +5 to -60 dB and is recommended for viewing the high frequency portion of the graph. This allows a clearer view of the difference between the actual result and the ITU-T pass mask.

NARROW provides a vertical axis range of +3 to -3 dB and is recommended for viewing the low frequency portion of the graph. This allows a clearer view of the difference between the actual result and the ITU-T pass mask.

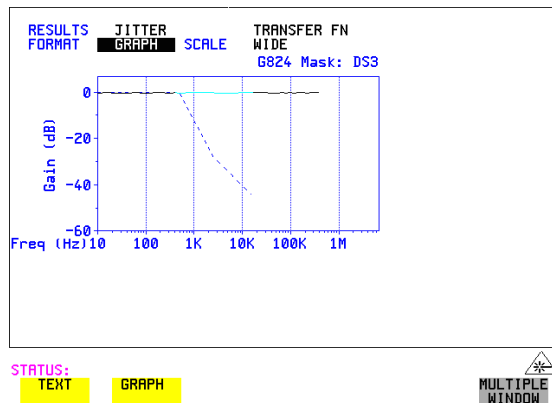

3 If you wish to log the jitter tolerance results to a printer see “Logging Jitter Transfer Results” page 266.

Measuring Pointer Adjustment (Tributary) Jitter

Introduction

During the transition from a PDH network to mixed PDH/SDH networks new sources of jitter emerge, caused by the mapping process and network synchronization problems. This new jitter may result in pointer adjustments which in turn cause tributary jitter at the PDH output ports of the network element.

Pointer Adjustment Jitter

Jitter resulting from pointer adjustments is transient in nature, relatively high in amplitude, and most of the energy is contained in low frequency components.

ITU-T G.783 and ETSI TM-1015 recommendations define a set of pointer sequences when evaluating NE's pointer adjustment jitter performance. These sequences are designed to emulate the pointer activity that results from incorrect synchronization within a network element.

The OmniBER Transmitter can generate the test sequences recommended by ITU-T G.783/ETSI TM-1015. Use these sequences to stress the system under test for correct levels of tributary jitter.

Refer to "Adding Pointer Adjustments" on page 87 for instructions on how to add pointer adjustments and detailed explanations of the pointer sequences provided by the OmniBER.

Making Measurements

Measuring Pointer Adjustment (Tributary) Jitter

ITU-T G.783 Jitter Specification

Payload	Pointer	Sequence	Measurement bandwidth	Max. Jitter (UI p-p)
1.5 Mb/s	TU-11	E, F	0.01 to 40 kHz*	1.5
2 Mb/s	TU-12	A, B, C A, B, C	0.02 to 100 kHz * 18 to 100 kHz **	0.4 0.075
34 Mb/s	TU-3	A, B, C D A, B, C, D	0.1 to 800 kHz * 0.1 to 800 kHz * 10 to 800 kHz **	0.4 0.75 0.075
45 Mb/s	TU-3	E, F, G, H	Note 1.	Note 1.
140 Mb/s	AU-4	A, B, C D, G A, B, C, D, G	0.02 to 3500 kHz * 0.02 to 3500 kHz* 10 to 3500 kHz **	0.4 0.75 0.075

*denotes LP + HP1 filters. ** Denotes LP + HP2 filters;
Note 1 These values are for further study by ITU-T.

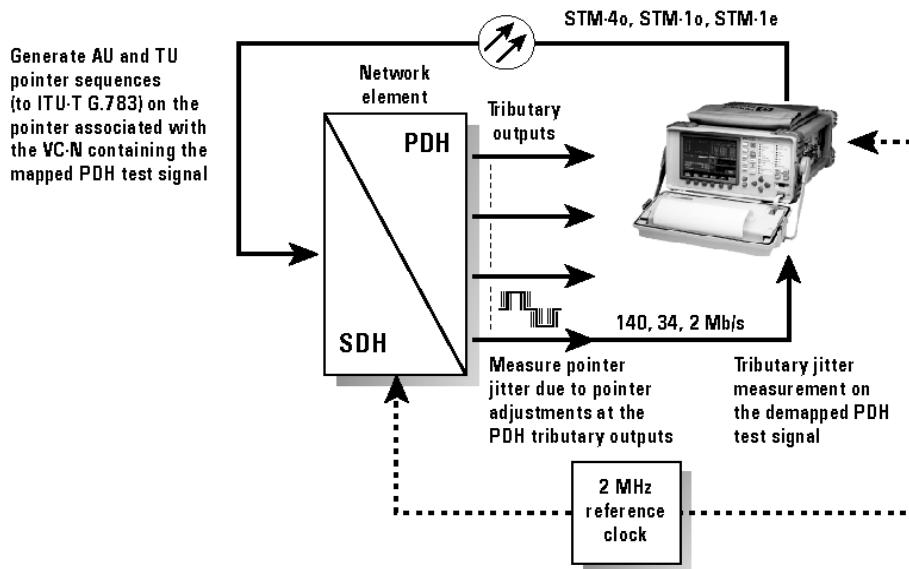

Typical tributary jitter test setup

Making Measurements

Measuring Pointer Adjustment (Tributary) Jitter

HOW TO:

- 1 Connect the OmniBER to the Network Element as shown in the previous Figure. Ensure the OmniBER and the NE are synchronized.
- 2 Select the **OTHER** **SETTINGS CONTROL** page and choose TRANSMITTER AND RECEIVER **INDEPENDENT**.
- 3 Select **RECEIVE**, **MAIN SETTINGS**, **PDH/DSn** and select a PDH/DSn SIGNAL rate (140, 34, 8 or 2 Mb/s plus DS1 or DS3).
- 4 On the same page set the required test pattern from the PATTERN field.
- 5 On the **TRANSMIT**, **SDH**, **MAIN SETTINGS** page select a SIGNAL rate (the rates available depend on the options fitted to your instrument). In this example we have selected STM-16 OPT.
- 6 On the same page, now set the Transmitter PDH payload offset (140M OFFSET field in figure below) to any in-range value.

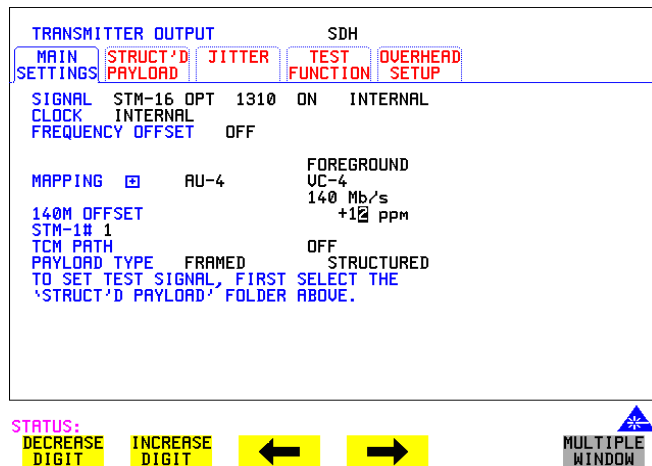

- 7 Select **TRANSMIT**, **SDH**, **TEST FUNCTION**, then select **SDH**, **ADJUST PTR**.
- 8 Setup and run pointer sequence A (see page 87 for information on the pointer sequences available). When the pointer sequence initialization and cool-down periods are finished and the display indicates "POINTER SEQUENCE - IN PROGRESS" proceed to step 9.

Making Measurements

Measuring Pointer Adjustment (Tributary) Jitter

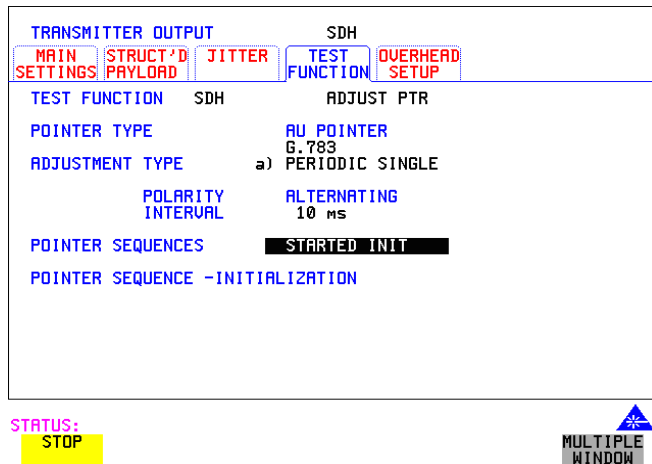

- 9 Select **RESULTS**, **TIMING CONTROL** and set TEST TIMING to **SINGLE** and a period of 20 seconds.
- 10 Set the jitter measurement range to 1.6 UI and measurement filter to LP+HP1, as shown below.
- 11 Press **RUN/STOP** to start the measurement.

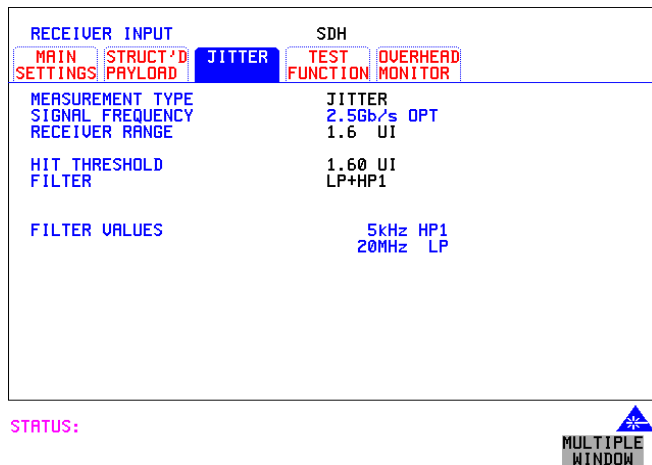

- 12 Verify that no alarms or errors are detected by the OmniBER receiver.

Making Measurements

Measuring Pointer Adjustment (Tributary) Jitter

- 13 Set the **RESULTS**, **JITTER** page to **CUMULATIVE** and AMPLITUDE.
- 14 Measure and record peak-to-peak jitter from ten consecutive measurement periods.
- 15 Change the filter setting to LP+HP2, and repeat step 13.
- 16 Repeat the above procedure for pointer sequences B, C, D, E, F and G as required.

"Setting up the Transmitter for ATM Payloads " page 154

"Setting up the Convergence Sublayer " page 157

"Setting Foreground Traffic " page 159

"Transmitting ATM Alarms " page 165

"Adding ATM Errors " page 167

"Viewing ATM Results " page 169

"Setting up the Receiver for ATM Payloads " page 170

"Setting up the Receiver ATM signal " page 172

"Policing ATM Traffic " page 174

"Measuring ATM Delay Performance " page 176

"Measuring ATM Alarms " page 179

"ATM Service Disruption " page 180

ATM Operation

For ATM operation you must have option 300 installed.
Option 300 offers ATM up to 2.5 Gb/s.

ATM Operation

Setting up the Transmitter for ATM Payloads

Setting up the Transmitter for ATM Payloads

Description

The transmitter rate and mapping can be set up to match the requirements of the ATM network under test. At SDH, select a rate from STM-0 to STM-16 Optical or PDH/DSn rates of 34 Mb/s, 2 Mb/s, DS1 or DS3.

TIP

To set the Transmitter and Receiver to the same interface settings choose **OTHER SETTINGS CONTROL COUPLED**.

NOTE

For ATM in PDH/DSn you must select ATM in the Receiver before it can be selected in the Transmitter (unless the instrument is coupled).

Note ATM Mappings are performed using ITU-T Recommendation G.707 and G.804 and ATM Forum physical layer specifications.

RESULT TYPE	COUNTS
BIT	0
CORRECTED HEC	0
NON-CORRECTED HEC	0
LOST CELLS	N/A
ERRORED CELLS	0
MISINSERTED CELLS	N/A
NON-CONFORMING CELLS	N/A
HEAVY CELL TRANSFER DELAY	N/A
MAX CELL TRANSFER DELAY	N/A
2-PT CDV	N/A
PLCP BIT	N/A
ELAPSED TIME	00d 00h 00m 02s

How to

- 1 On the **TRANSMIT** page select from **PDH/DSn** or **SDH**.
- 2 Select the SIGNAL rate. (If you selected a PDH/DSn interface and have not coupled the Transmitter and Receiver, have you selected ATM in the Receiver first?).
- 3 Select required MAPPING and then select **ATM**.

ATM Operation

Setting up the Transmitter for ATM Payloads

Use **SET** to bring up the popup application diagram (only applies to SDH mappings). This allows an alternative way of selecting the appropriate mapping.

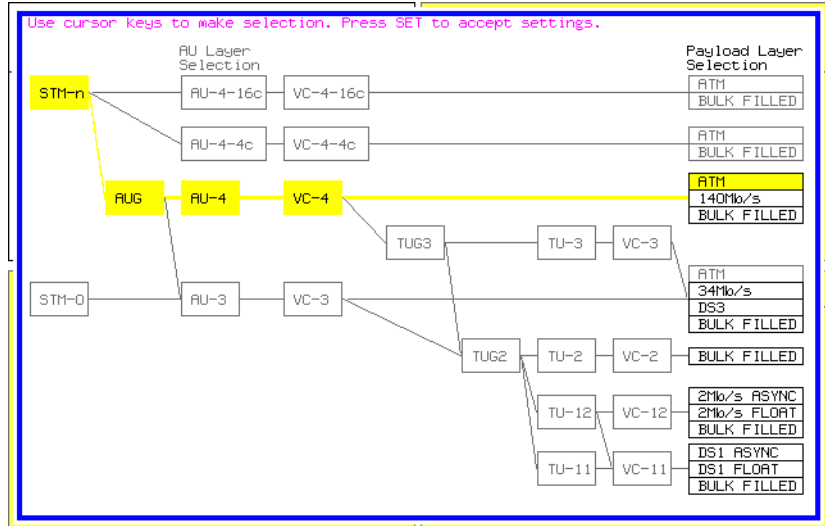

STATUS:



Table 5

ATM availability with PDH/DSn and SDH Signal Rates and Framing

Signal Rate	Framing Type	Is ATM available?
DS3	CBIT M13	yes no
DS1	ESF D4 SLC96	yes no no
2 Mb/s	PCM30 PCM30CRC PCM31 PCM31CRC	yes yes no no
8Mb/s	-----	no
34 Mb/s	G.832 Framed	yes no
140 Mb/s	-----	no
SDH	ATM is available into all VC mappings, but not into a TU structure.	

ATM Operation

Setting up the Convergence Sublayer

Setting up the Convergence Sublayer

Description

Setting up the Convergence Sublayer allows the test signal to be set to suit the ATM network under test.

How to

- 1 Set up the Transmitter for ATM in the MAIN SETTINGS folder (See "Setting up the Transmitter for ATM Payloads " page 154").
- 2 Select the **ATM SETTINGS** folder.

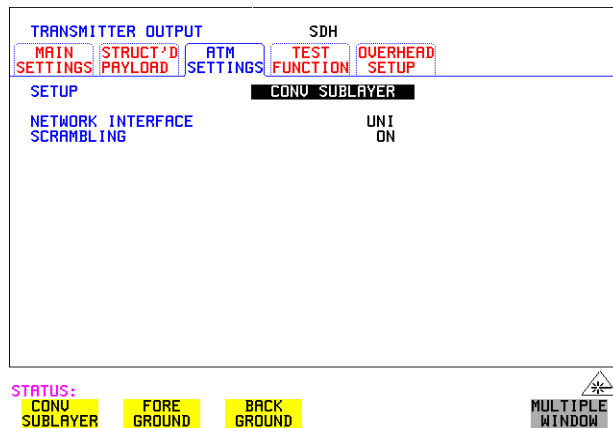

- 3 Select SETUP as required.
- 4 If **CONV SUBLAYER** is selected then the NETWORK INTERFACE can be selected as **UNI** or **NNI** and the SCRAMBLING can be turned on or off. For most applications ATM scrambling should be left on. If a DS3 interface and CBIT framing is selected an additional field CONVERGENCE SUBLAYER can be set to **DIRECT** or **PLCP**.

Network Interface

The cell header format used at the User Network Interface (UNI) and Network Node Interface (NNI) differs. The UNI has a Generic Flow Control field which can be used for Media Access Control (MAC) functions to transmit cells over shared media systems, while the NNI uses these four extra bits for extra path addressing.

ATM Operation
Setting up the Convergence Sublayer

Cell Header at UNI

Bits								
8	7	6	5	4	3	2	1	Bytes
GFC				VPI				1
VPI				VCI				2
VCI								3
VCI				PTI		CLP		4
HEC								5

Cell Header at NNI

Bits								
8	7	6	5	4	3	2	1	Bytes
VPI								1
VPI				VCI				2
VCI								3
VCI				PTI		CLP		4
HEC								5

GFC - Generic Flow Control

VPI - Virtual Path Identifier

VCI - Virtual Channel Identifier

PTI - Payload Type

CLP - Cell Loss Priority

HEC - Header Error Control

Setting Foreground Traffic

Description

There are one foreground and seven background ATM channels available for testing. The backgrounds are used to simulate real traffic which can be routed differently to the foreground channel. The foreground is the test channel you use to stress the system under test.

Refer to page 161 for a description of how to set up background traffic. The relative distribution of background and foreground is described on page 162.

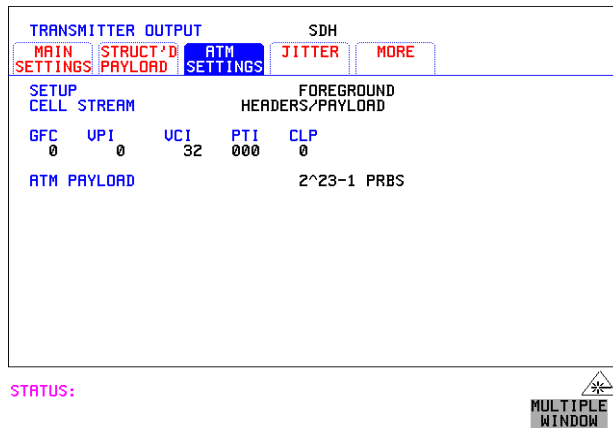

How To

Foreground Setup

- 1 Set up the Transmitter for ATM in the MAIN SETTINGS folder (See "Setting up the Transmitter for ATM Payloads " page 154").
- 2 Select **TRANSMIT** and the **ATM SETTINGS** folder as shown above, and set the SETUP field to **FOREGROUND**. Set the ATM header as required using the cursor keys.
- 3 Select an ATM Payload from the choices offered.
To make a range of error measurements on your connection, select **TEST CELL** as the payload in the transmitter and the receiver. This allows the measurement of cell errors, cell loss, cell misinsertion and cell delay simultaneously. For a simple BER measurement you can select **PRBS** or **USER** byte. When making a jitter tolerance measurement, select **PRBS**.

ATM Operation
Setting Foreground Traffic

What is a test cell? Simultaneous measurement of all ATM performance parameters can be made using a special-purpose test cell. The test cell is described in ITU 0.191. The cell payload consists of a 4-byte sequence number (SN) which is used to detect lost or misinserted cells, a 4-byte timestamp (TS) which is used for cell delay and CDV measurements, a 1 byte test cell payload type (TCPT) and a 2-byte CRC-16 which is used for error detection and protection of the sequence number and timestamp.

An example of the test cell is given below.

Test Cell

header 5 bytes	SN 4 bytes	TS 4 bytes	Unused 37 bytes	TCPT 1 byte	CRC-16 2 bytes
-------------------	---------------	---------------	--------------------	----------------	-------------------

ATM Operation

Setting Background Traffic

Setting Background Traffic

Description

You can select up to seven background channels which can be used to represent typical ATM traffic. The background channels are non-test channels and are used to fully load the element under test.

The screenshot shows a terminal window with the following content:

```
TRANSMITTER OUTPUT          SDH
MAIN STRUCT'D ATM          JITTER MORE
SETTINGS PAYLOAD SETTINGS
-----
SETUP          BACKGROUND
CELL STREAM   HEADERS

BG GFC UPI  UCI  PTI  CLP
1 00  1   32  000  0
2 00  2   32  000  0
3 00  3   32  000  0
4 00  4   32  000  0
5 00  5   32  000  0
6 00  6   32  000  0
7 00  7   32  000  0
```

Below the terminal window, there are three status indicators: CONU (yellow), FORE (yellow), and BACK (yellow). To the right, there is a 'MULTIPLE WINDOW' icon.

How To

- 1 Set the SETUP field to **BACKGROUND**.
- 2 Set CELL STREAM to **HEADERS** and set up the Background Headers as required, using the cursor keys to navigate through the header fields.

Setting Foreground and Background Distributions

Description

The ATM Forum has defined the following Service Categories:

- Constant Bit Rate (CBR)
- Variable Bit rate (VBR)
- Unspecified Bit Rate (UBR)
- Available Bit Rate (ABR)

Data carried within each of these Service Categories will be policed within the network to ensure that the traffic does not exceed the bandwidth negotiated. This ensures that the quality of service can be met and that other traffic is not degraded.

In the OmniBER the distribution of the ATM cells in the data stream can be set up to give CBR, VBR and single burst to simulate typical ATM traffic. Note that Background distributions are CBR. You can select the transmit cell rate in steps of 1 cell per second up to the maximum cell rate, giving you precise and accurate cell rates for performance tests and verifying ATM policing functions.

Because UBR is policed in a similar manner to CBR, a CBR signal can be used to represent UBR data. In ABR, dynamic control of the signal bandwidth is provided by resource management cells. However, a limited error performance test may be performed using a fixed bandwidth CBR signal.

The screenshot shows a software interface for configuring ATM settings. At the top, there are several menu options: TRANSMITTER OUTPUT, SDH, MAIN SETTINGS, STRUCT'D PAYLOAD, ATM SETTINGS, JITTER, and MORE. The 'ATM SETTINGS' menu is selected, and the 'FOREGROUND DISTRIBUTION' sub-menu is active. The main display area shows the following configuration:

	CELLS/S	KBITS/S
PEAK CELL RATE	353206	149759
CDU TOLERANCE	10 μ s	

At the bottom of the interface, there is a 'STATUS:' section with three indicators: CONU (CONVOLUTIONAL) SUBLAYER, FORE GROUND, and BACK GROUND. A 'MULTIPLE WINDOW' icon is also visible in the bottom right corner.

Setting Foreground and Background Distributions

How to

Setting up foreground

- 1 Set up the Transmitter for ATM (See "Setting up the Transmitter for ATM Payloads " page 154).
- 2 In the **ATM SETTINGS** folder select SETUP as **FOREGROUND**, CELL STREAM as **DISTRIBUTION** and then the traffic parameters for the Virtual Channel (VC) under test can be set up.
- 3 **Service Selections:**
For Constant Bit Rate (CBR) traffic, select the PEAK CELL RATE and CDV tolerance.
For Variable Bit Rate (VBR) traffic, select the SUSTAINABLE CELL RATE, PEAK CELL RATE, MAXIMUM BURST SIZE and CDV tolerance. The OmniBER then automatically generates worst case user traffic for the VC under test using the 0.191 enhanced traffic generator algorithm.
For error performance measurement, set the CDV tolerance value to its minimum value.
Select SINGLE BURST to transmit a burst of cells at the selected cell rate.

NOTE

The CDV tolerance value cannot be set to zero. The minimum value reflects the inherent CDV that is generated due to the segmentation and mapping of the ATM cell stream into the physical interface.

To fully stress the policing functions of the VC under test, the CDV tolerance can be set to the value used in the policing function.

Peak Cell Rate

For CBR, the peak cell rate is the average rate at which cells will be transmitted. Because the selected cell rate is implemented by a series of discrete cell events, for arithmetical reasons there will be some unavoidable deviation from ideal periodic timing. This effect is small.

Cell Delay Variation Tolerance (CDVT)

The transmitter will generate a signal which has a cell delay variation as set by the user in order to test a receiver's cell delay variation tolerance.

Sustainable Cell Rate

For VBR, this is the long term average cell rate being transmitted.

ATM Operation

Setting Foreground and Background Distributions

Burst Size

This is the number of cells transmitted at the peak cell rate, a value which may vary from the selected value due to cell delay variation.

Setting up background

How To

- 1 Selecting the SETUP as **BACKGROUND** and CELL STREAM as **PAYLOAD/DISTRIBUTION** allows the 7 backgrounds to be set up. The payload can be set up as an 8-bit user-selectable pattern for each background. The number of cells per second on each background can also be set. This is limited by the bandwidth which is occupied by the foreground. Setting a unique value in the payload byte for each background can help you to trace and identify cell streams later.

The screenshot shows a terminal window with a menu at the top: TRANSMITTER OUTPUT, SDH, MAIN SETTINGS, STRUCT'D PAYLOAD, ATM SETTINGS, JITTER, and MORE. The 'BACKGROUND PAYLOAD/DISTRIBUTION' menu is selected. Below the menu, the following data is displayed:

FOREGROUND		%BW	99.9
BG	PAYLOAD	CELLS/S	KBITS/S
1	00000001	0	0
2	00000010	0	0
3	00000011	0	0
4	00000100	0	0
5	00000101	0	0
6	00000110	0	0
7	00000111	0	0
FILL	IDLE	%BW	0.1

At the bottom of the window, there are three status indicators: 'STATUS: HEADERS' (highlighted in yellow), 'PAYLD./DISTR' (highlighted in yellow), and 'MULTIPLE WINDOW' (with a small icon).

Note

If there is any extra bandwidth left over after the foreground and background are filled with FILL CELLS, you can select between IDLE or UNASSIGNED Cells to fill the remaining cells.

Transmitting ATM Alarms

Description

You can generate VP and VC AIS and RDI alarms to verify the response of the ATM Network under test, and also generate VP and VC Continuity check cells to keep the circuit alive during bursty traffic conditions.

Types of alarms available are: VP-AIS, VP-RDI, VP-CC, VC-AIS, VC-RDI and VC-CC. The following tables show the expected responses of ATM VP and VC switches to input conditions.

Downstream Alarms

Stimulus	Response: VP switch	Response: VC switch
LOS, LOF, LOP	VP-AIS	VC-AIS
MS-AIS, Path AIS	VP-AIS	VC-AIS
LCD	VP-AIS	VC-AIS
VP-LOC	VP-AIS	VC-AIS
VP-AIS	VP-AIS	VC-AIS
VC-LOC	none	VC-AIS
VC-AIS	none	VC-AIS

Upstream Alarms

Stimulus	Response: VP switch	Response: VC switch	Response: VC end point
LOS, LOF, LOP	MS-RDI	MS-RDI	MS-RDI
MS-AIS, Path AIS	Path RDI	Path RDI	Path RDI
LCD	Path RDI	Path RDI	Path RDI
VP-LOC	none	VP-RDI	VP-RDI
VP-AIS	none	VP-RDI	VP-RDI
VC-LOC	none	none	VC-RDI
VC-AIS	none	none	VC-RDI

ATM Operation

Transmitting ATM Alarms

The following figure illustrates an example where the ability of a network element to recognize and respond to AIS and RDI alarms is tested.

AIS/RDI Alarm Testing

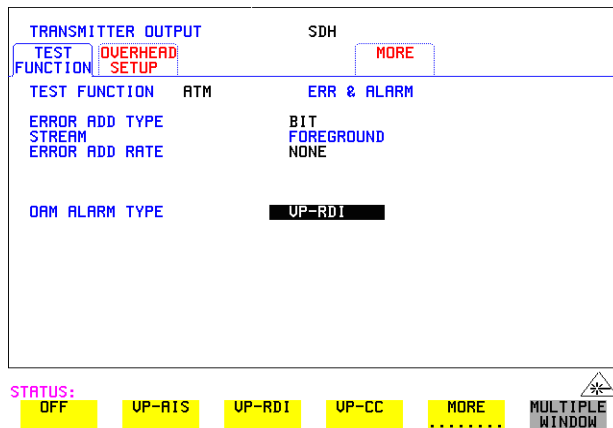
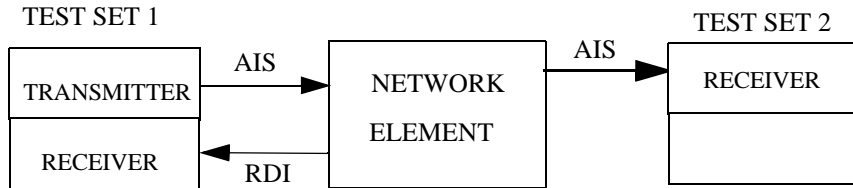

How to

- 1 Set up the Transmitter for ATM (See "Setting up the Transmitter for ATM Payloads " page 154).
- 2 Select the Transmitter **TEST FUNCTION** folder, and select TEST FUNCTION as **ATM** .
- 3 Move the down cursor to OAM ALARM TYPE and select the alarm you require to test your network element.

OAM cells are transmitted when the OAM ALARM TYPE has an alarm selected. For VP or VC AIS, any channel with the same VP or VC is suspended and the OAM cell is transmitted once per second. For VP or VC RDI the OAM cell is interspersed with the foreground channel.

Adding ATM Errors

Description

Errors can be added to the ATM payload and to the cell headers. To stress ATM header alignment, you can add bursts of single or double header errors. To simulate ATM impairments, you can add bit errors, cell loss, cell misinsertion or cell errors.

Cell loss may be caused by transmission errors on the ATM header or more importantly may arise due to congestion in ATM switches. *Cell misinsertion* may also be caused by transmission errors on the ATM overhead. If errors cause the VP/VC to be changed to another valid value, this will cause a cell to be misinserted into another channel. Also, faults within the routing tables or management system of an ATM switch may cause cells to be routed to the wrong output port, appearing as misinserted cell. *Cell errors* caused by transmission impairments or faults within Network Equipment need to be measured in a different way from bit errors to ensure that lost or misinserted cells do not corrupt the measurement.

In order to make the necessary ATM measurements a different kind of test signal than that traditionally used to measure BER is required. This test signal is known as the *test cell* and has been designed and endorsed by the ATM Forum and standardized in the ITU-T in Recommendation 0.191. OmniBER uses the test cell to make simultaneous ATM error measurements.

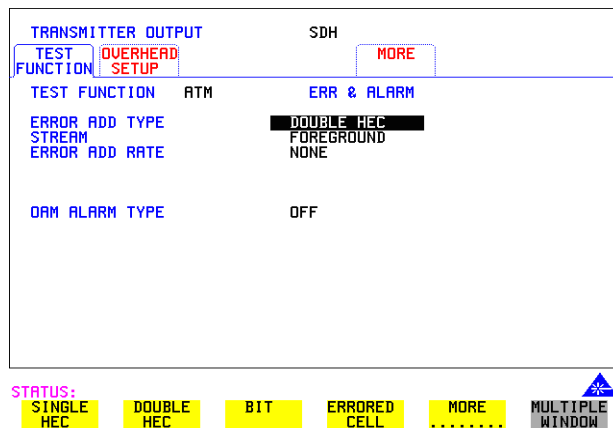

How to

- 1 Set up the **TRANSMIT** page for ATM (See "Setting up the Transmitter for ATM Payloads " page 154).

ATM Operation

Adding ATM Errors

- 2 Move to the **TEST FUNCTION** folder and select TEST FUNCTION to be **ATM**.
- 3 Move the down cursor to ERROR ADD TYPE and select the Error Type you require.

Note

When you select **ALL** in the STREAM field an additional field appears which allows you to introduce a burst of errors.

To Verify HEC Function

- 1 Add SINGLE HEC errors and verify that the Network Element corrects these errors
- 2 Add DOUBLE HEC errors and verify that a lost cell is recorded for each Double HEC error. (To measure lost cells, select TESTCELL as the payload).
- 3 Add a burst of 2 SINGLE HEC errors and verify that one lost cell is recorded. The first error is corrected; the second is not.
- 4 Add a burst of 7 DOUBLE HEC errors and verify that LCD occurs in the Network Element.

Viewing ATM Results

Description

The ATM results can be viewed in a variety of ways on the RESULTS page.

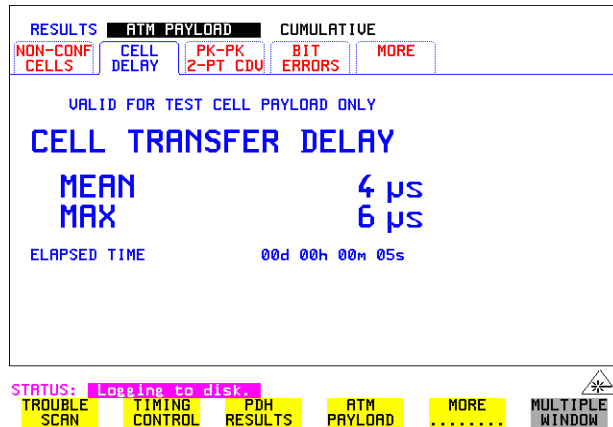

How to

- 1 Press the **RESULTS** key.
- 2 Select **ATM PAYLOAD** in the RESULTS field.
- 3 Move the right cursor to select the different types of errors and alarms.
- 4 **ERROR SUMMARY** gives a summary of all possible ATM errors and can be set up to be read as counts (total in measurement interval) or ratios/rates.
- 5 **CUMULATIVE** errors give the number of errors which have occurred in total since the last time **RUN/STOP** was pressed. **SHORT TERM** errors give the number of errors which have occurred in the last measurement interval. This measurement interval is set up on the results page when **TIMING CONTROL** has been selected in the RESULTS field.
- 6 **ALARM SECONDS** is used to look at ATM alarms.

Setting up the Receiver for ATM Payloads

Setting up the Receiver for ATM Payloads

Description

The receiver rate and mapping can be set up to match the requirements of the ATM network under test. At SDH, select a rate from STM-0 to STM-16 Optical or PDH/DSn rates of 34 Mb/s, 2 Mb/s, DS3 or DS1.

TIP

To set the Transmitter and Receiver to the same interface settings choose **OTHER SETTINGS CONTROL**, **COUPLED**.

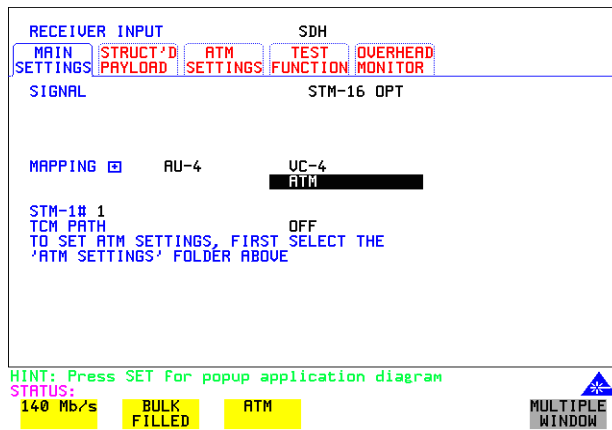

ATM Operation

Setting up the Receiver for ATM Payloads

How to

- 1 Press **RECEIVE** and select from **PDH/DSn** or **SDH**.
- 2 Select the SIGNAL rate.
- 3 Select required MAPPING with ATM as a payload.
Use **SET** to bring up the popup application diagram (only applies to SDH mapping). This allows an alternative way of selecting the appropriate mapping.
Use the cursor keys to navigate through the popup application diagram.

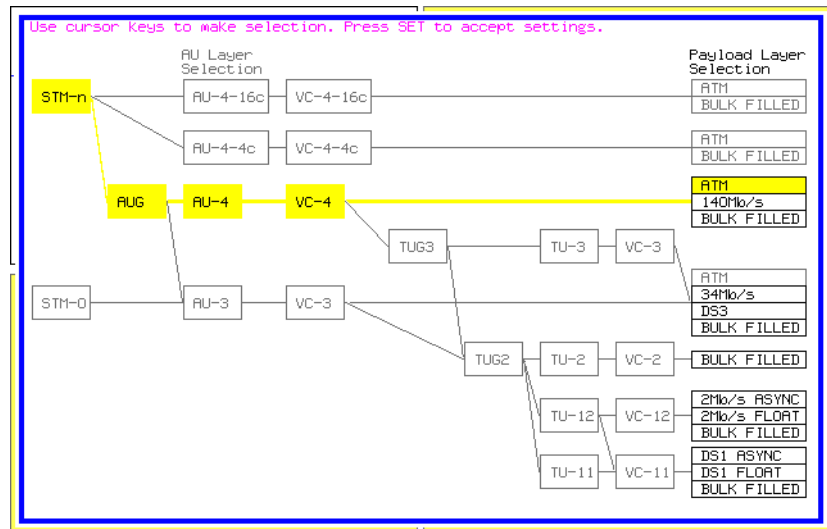

STATUS:

SINGLE WINDOW

ATM Operation

Setting up the Receiver ATM signal

Setting up the Receiver ATM signal

Description

You can set up the ATM receiver signal to suit the network under test.

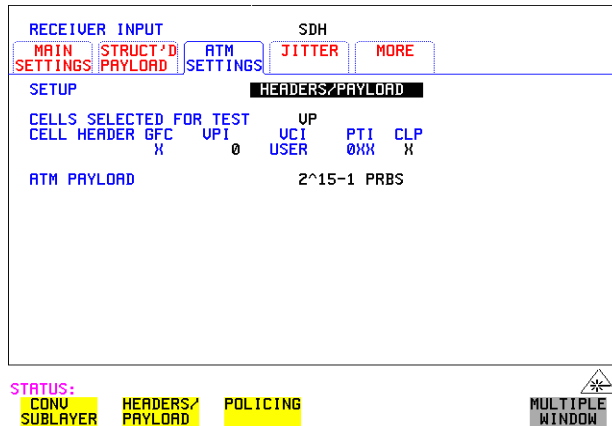

How to

- 1 Select the Receive rate and mapping. (See "Setting up the Receiver for ATM Payloads " page 170).
- 2 Select the **ATM SETTINGS** folder.
- 3 Select SETUP as **CONV SUBLAYER**, **HEADERS/PAYLOAD** or **POLICING** (See "Policing ATM Traffic " page 174).
- 4 If **CONV SUBLAYER** is selected then the network interface can be selected as UNI or NNI (see diagrams on next page) and the SCRAMBLING can be turned on or off. For most applications ATM scrambling should be left on. The HEC CORRECTION can be enabled/disabled at this point. Header error correction (HEC) allows the correction of a single header error. To simulate a typical ATM receiver it should be switched ON.
- 5 If **HEADERS/PAYLOAD** is selected the CELLS SELECTED FOR TEST can be set up. To test a Virtual Path, select **VP** and set the VPI value. To test a VC, select **VC** and set the VPI and VCI. For specialist applications, you can select **EXPERT** mode to give complete flexibility in setting up the receiver. **ALL USER** cells is used to give a quick indicator of the total cells bandwidth being used.

ATM Operation

Setting up the Receiver ATM signal

NOTE

Select VP or VC for most test applications. ATM alarms are only monitored if VP or VC is selected.

- 6 To measure error or delay performance of the ATM connection, select **TEST CELL** as the payload in the transmitter and the receiver. This allows the measurement of cell errors, cell loss, cell misinsertion and cell delay simultaneously. For a simple BER measurement you can select **PRBS** or **USER BYTE**. When making a jitter tolerance measurement, select **PRBS**.

Cell Header at UNI

Bits								
8	7	6	5	4	3	2	1	Bytes
GFC				VPI				1
VPI				VCI				2
VCI								3
VCI				PTI		CLP		4
HEC								5

Cell Header at NNI

Bits								
8	7	6	5	4	3	2	1	Bytes
VPI								1
VPI				VCI				2
VCI								3
VCI				PTI		CLP		4
HEC								5

GFC - Generic Flow Control, VPI - Virtual Path Identifier
VCI - Virtual Channel Identifier, PTI - Payload Type
CLP - Cell Loss Priority, HEC - Header Error Control

Policing ATM Traffic

Description

Policing ATM traffic allows the user to check whether the incoming ATM service complies with the traffic contract.

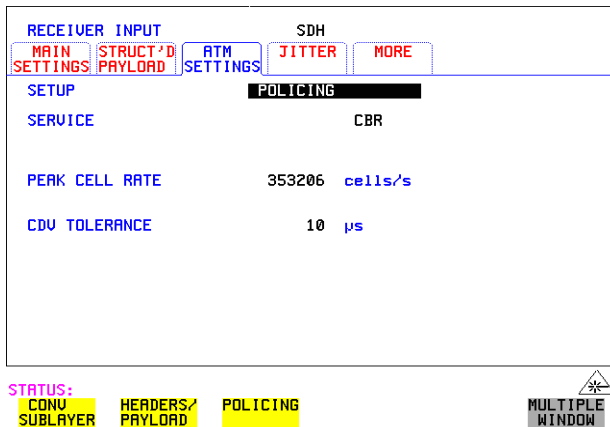

How to

- 1 Set up the Transmitter for ATM (See "Setting up the Transmitter for ATM Payloads " page 154).
- 2 Set up the Receiver for ATM (See "Setting up the Receiver ATM signal " page 172).
- 3 Select the **ATM SETTINGS** folder.
- 4 Select SETUP as **POLICING**.
- 5 To test a Continuous Bit Rate (CBR) service select the service **CBR**. Then set up the PEAK CELL RATE and CDVT. Any incoming signal which violates the peak cell rate or cell delay variation will result in NON-CONFORMING CELLS error. Because UBR traffic is policed in a similar manner to CBR, you can select CBR to police UBR traffic. In ABR dynamic control of the signal bandwidth is provided by resource management cells. However ABR is policed in a similar manner to CBR and so you can select CBR to police ABR traffic that is not changing.
- 6 To test a Variable Bit Rate (VBR) service select **VBR**. Then set up the SUSTAINABLE CELL RATE, the PEAK CELL RATE, the MAXIMUM BURST SIZE and the CDV TOLERANCE (See page 163 for definitions).
- 7 If the received cell stream does not conform to the policing parameters set up,

ATM Operation
Policing ATM Traffic

non-conforming cells are recorded. To view these cells, see "Viewing ATM Results " page 169.

Measuring ATM Delay Performance

Description

Cell delay can be a problem in any two-way communication system, for example in voice communications, conversation becomes increasingly difficult as path delays increase. In a similar manner, data communications throughput is decreased if significant delay (or latency) slows down the speed that messages can be acknowledged by the receiving terminal.

Cell delay variation (CDV) is caused by dynamic changes in the delay characteristic of an ATM connection. CDV causes problems in buffer underflow and overflow in play-out buffers used to recreate a CBR service. (This results in cell loss and the corresponding corruption of the data being carried. If the clock used to generate the CBR data is derived from the incoming data (adaptive clock method), excessive CDV may cause the PLL to lose lock). CDV may also be a problem for data carried on rt-VBR connections, like VBR video, where accurate timing recovery is critical to the observed quality of the decoded video signal (accumulation of CDV can increase the probability of cell loss due to switch congestion).

During design and verification, it may be necessary to test the delay and CDV of an ATM Network Element under load conditions to ensure that delay performance parameters can be guaranteed.

Measuring ATM Delay Performance

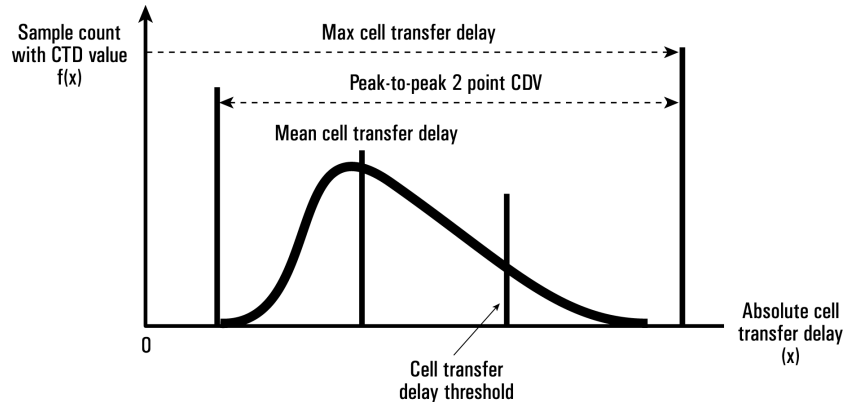

Cell Delay

ATM delay measurements

Each cell transmitted may experience a different delay through the ATM network. The delay calculated for each cell can be analyzed over a period of time to produce delay measurements. The following ATM cell delay measurements have been standardized by the ATM Forum and also in ITU-T Recommendation O.191.

- Mean cell transfer delay: the average of the delays calculated for each cell over the measurement time.
- Maximum cell transfer delay: the maximum value of delay calculated over the measurement time.
- Peak to peak two point CDV: the difference between the maximum delay and the minimum delay calculated over the measurement time.

These measurements are made using the timestamp field within the O.191 test cell.

ATM Operation

Measuring ATM Delay Performance

How to

- 1 Set up the **TRANSMIT** page for ATM see "Setting up the Transmitter for ATM Payloads " page 154.

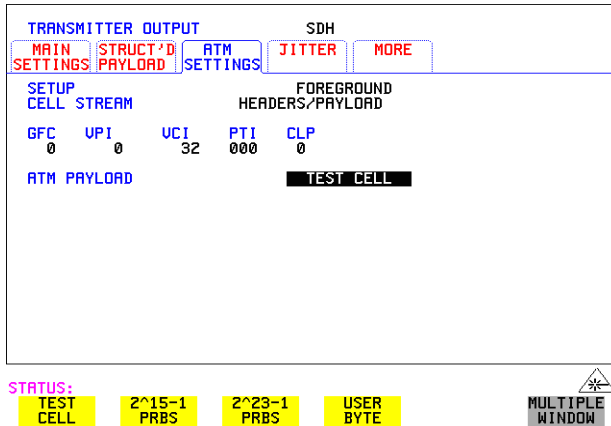

- 2 Select TEST CELL as the transmit and receive payload as shown above.
- 3 Select RESULTS and view the Delay and CDV results, an example is given below.

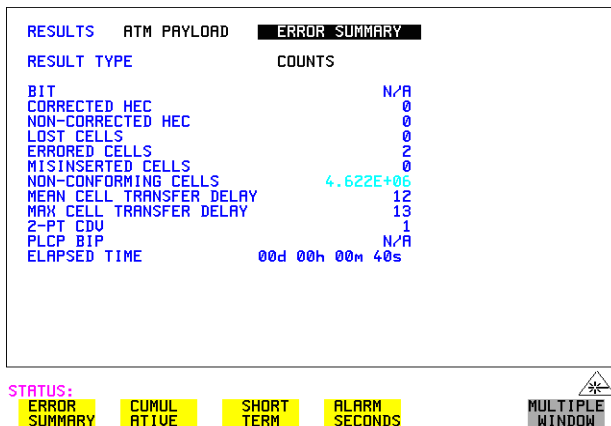





Note: Delay measurements such as mean cell transfer delay are only valid if you perform a round trip measurement, that is, when a transmitter and receiver are in the same instrument. You can perform a CDV measurement end to end, that is, using two separate instruments to transmit and receive.

Measuring ATM Alarms

Description

You can generate VP and VC AIS and RDI alarms to verify the response of the ATM Network under test, and also generate VP and VC Continuity check cells to keep the circuit alive during bursty traffic conditions. Set up the OmniBER to generate AIS or RDI alarms and check the ability of your network element to recognize and respond to alarms.

RESULTS	ATM PAYLOAD	ERROR SUMMARY
RESULT TYPE	COUNTS	
BIT		N/A
CORRECTED HEC		0
NON-CORRECTED HEC		0
LOST CELLS		0
ERRORED CELLS		0
MISINSERTED CELLS		0
NON-CONFORMING CELLS		0
MEAN CELL TRANSFER DELAY		0
MAX CELL TRANSFER DELAY		8149329
2-PT CDU		19036913
PLCP BIP		N/A
ELAPSED TIME		00d 00h 00m 27s

STATUS:     

How To

- 1 Set up the **TRANSMIT** page for ATM (see "Setting up the Transmitter for ATM Payloads " page 154).
- 2 Set up the Transmitter to generate ATM alarms (see "Transmitting ATM Alarms " page 165).

NOTE

VP ALARMS WILL ONLY BE DETECTED IF THE CELL SELECTED FOR TEST IS VP OR VC.
VC ALARMS WILL ONLY BE DETECTED IF THE CELL SELECTED FOR TEST IS VC.

- 3 Check that the appropriate LED illuminates on the instrument front panel when alarms are generated.
- 4 On the **RESULTS** page select RESULTS as **ATM PAYLOAD**, **ALARM SECONDS**.

ATM Service Disruption

Description

The ATM service disruption test measures the time during which cells are lost or errored while they pass through a network element. There are a number of reasons for such a disruption, from a break in the line which may activate a protection switch to an ESD discharge causing a temporary interruption to the ATM service.

To make valid Quality of Service measurements the actual time that traffic is lost must be measured. To do this the OmniBER uses the test cell as a payload. The test cell is a special cell, defined in ITU-T Recommendation 0.191, which allows the detection of lost, mis-inserted and errored cells simultaneously. These key parameters are input to the ATM service disruption measurement. The measurement time starts at the last good cell before the disruption and finishes whenever the first good cell arrives following a disruption. To ensure that the disruption has completely finished, 200ms of error free cells are required before the measurement is recorded. For maximum accuracy ensure the gap between cells does not exceed one second.

The screenshot displays the ATM Service Disruption test interface, which is divided into several sections:

- TRANSMITTER OUTPUT:** Shows SDH settings and a SETUP table for the cell stream. The SETUP table includes columns for GFC, VPI, VC1, PTI, and CLP, with values 0, 0, 32, 0, and 0 respectively. The ATM payload is identified as a TEST CELL.
- RECEIVER INPUT:** Shows SDH settings and a SETUP table for the cell stream. The SETUP table includes columns for GFC, VPI, VC1, PTI, and CLP, with values X, X, X, X, and X respectively. The ATM payload is identified as a TEST CELL.
- RESULTS:** Displays the longest and shortest service disruption times as 0.037ms and 0.009ms, and the last service disruption time as 0.009ms. The elapsed time is 00d 00h 00m 46s.
- FUNCTION SETTINGS CONTROL:** Shows the transmitter and receiver are coupled, and the receiver is coupled to the transmitter. ATM header values are not coupled.

At the bottom of the interface, there is a STATUS bar with several buttons: TROUBLE SCAN, TIMING CONTROL, SDH RESULTS, ATM PAYLOAD, MORE, and SINGLE WINDOW.

How To

To perform a service disruption measurement, set up the OmniBER as follows:

- 1 Set up the Transmitter for ATM, select the highest cell rate possible to ensure maximum accuracy (See "Setting up the Transmitter for ATM Payloads " page 154).
- 2 In the ATM SETTINGS folder set up the required service and traffic distributions. (See "Setting Foreground Traffic " page 159, "Setting

ATM Operation

ATM Service Disruption

Background Traffic " page 161 & "Setting Foreground and Background Distributions " page 162).

- 3 Set up the Receiver for ATM. (See "Setting up the Receiver for ATM Payloads " page 170).
- 4 In the Receiver ATM SETTINGS folder set up the service and filter required.
- 5 Verify that no errors/alarms are received (no red LEDs and the RESULTS page is clear of errors).
- 6 In the system under test, activate the protection switch or generate some kind of temporary system failure.
- 7 Go to the RESULTS page. In the first RESULTS field select **SRVC DISRUPT** and note the duration of the service disruption. Available measurements are LONGEST burst, SHORTEST burst and LAST burst.

ATM Operation
ATM Service Disruption

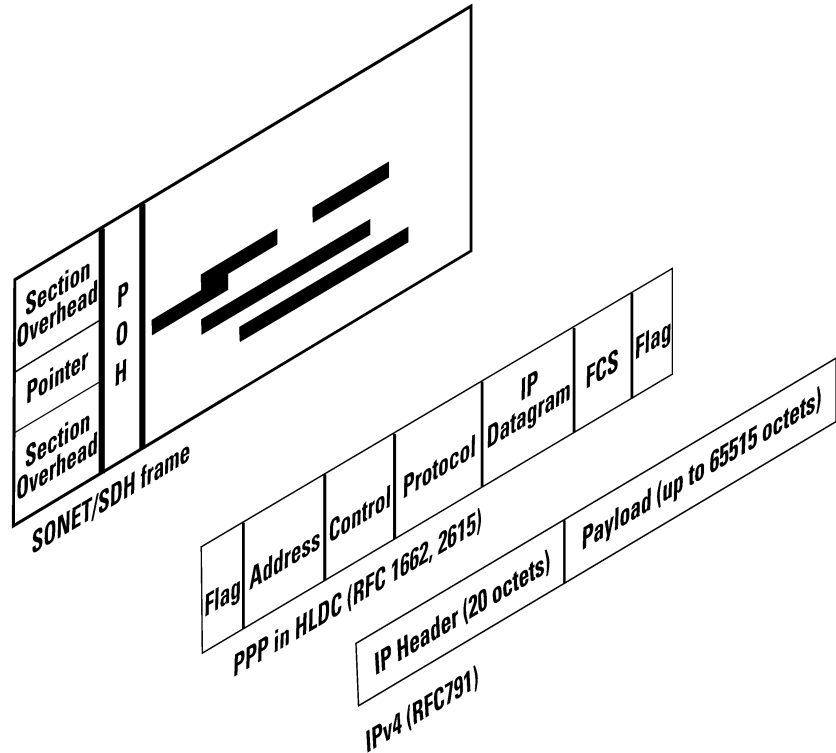

Packet over SDH (POS)

For POS operation you must have option 310 installed. Option 310 offers POS up to 2.5 Gb/s with a 37718A Mainframe, up to 622 Mb/s with a 37718B mainframe and up to 155 Mb/s with a 37718C mainframe.

Further information on POS technology/applications is supplied on the CD-ROM shipped with your instrument.

POS Protocol Stack

POS technology can be found in the line cards of high speed routers. It is a layer 2 protocol that maps IP packets into the SONET/SDH frame. Data is first of all segmented into an IP datagram that includes the 20-byte header. This datagram is encapsulated via PPP packets and framing information is added with HDLC-like framing. Gaps between frames are filled with flags (7E). The resulting data is scrambled, and mapped octet synchronously into the SONET/SDH frame.

POS is described by the Internet Engineering Task Force (IETF) in the following 'Request for Comment' (RFC) documents:

RFC-1661 (Point-to-Point Protocol), RFC-1662 (PPP in HDLC-like framing) and RFC-2615 (PPP over SONET/SDH).

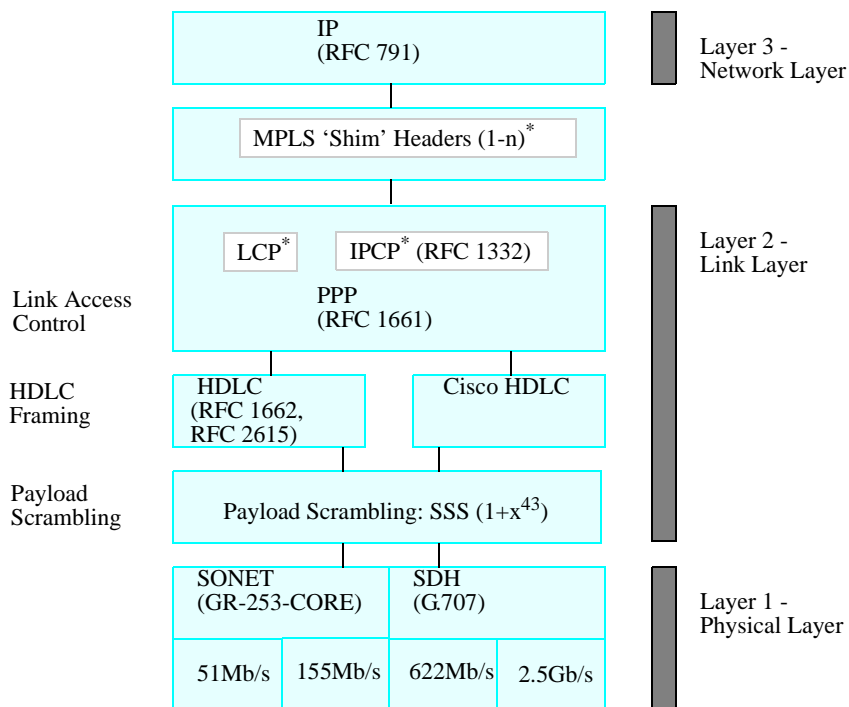

*MPLS supported on Rx but not on Tx

*LCP, IPCP not supported

Packet over SDH (POS) Setting up the Transmitter for POS Payloads

Setting up the Transmitter for POS Payloads

Description

The transmitter rate and mapping can be set up to match the requirements of the equipment under test. At SDH, select a rate from STM-0 to STM-16 optical.

CAUTION

Laser On/Off selection. Always switch off the laser before connecting or disconnecting optical cables.

TIP

To set the Transmitter and Receiver to the same interface settings choose **OTHER SETTINGS CONTROL COUPLED**. This causes the receiver to be configured to the same settings as the transmitter.

RESULTS	POS PAYLOAD	RESULT SUMMARY
RESULT TYPE		COUNTS
HDLC FRAMES		6.394E+07
HDLC FCS ERRORS		0
IP DATAGRAMS		6.394E+07
IP HEADER ERRORS		0
BIT ERRORS		0
ELAPSED TIME		00d 00h 00m 10s

HINT: Press SET for popup application diagram

STATUS:

BULK FILLED	POS
-------------	-----

SINGLE WINDOW

How to

- 1 Press the **TRANSMIT** key and select **SDH**.
- 2 Select the SIGNAL rate.
- 3 If Option 106, Dual Wavelength optical module, is fitted and an optical rate is chosen, choose the required wavelength (1550 or 1310).
If STM-0 is chosen, choose the required interface level (CROSS-CONNECT, HIGH or LOW).
Choose **INTERNAL** unless **THRU MODE** is required. If **THRU MODE** is chosen, see "Setting SDH THRU Mode " page 38.

Packet over SDH (POS)

Setting up the Transmitter for POS Payloads

- 4 Make your choice of CLOCK synchronization source. The clock can be internally sourced from the instrument, recovered from the signal at the optical RECEIVE port or externally sourced from the CLOCK REF IN ports (MTS 64 kb/s, BITS 1.5 Mb/s or 10 MHz REF).
- 5 If required choose the FREQUENCY OFFSET value. See “Adding Frequency Offset to SDH Signal” page 64.

Payload Mappings

The payload mappings available for POS in SDH are: VC4-16c, VC4-4c, VC-4 and VC-3.

- 6 Select required MAPPING and then select **POS**.
Alternatively, use **SET** to bring up the popup application diagram:

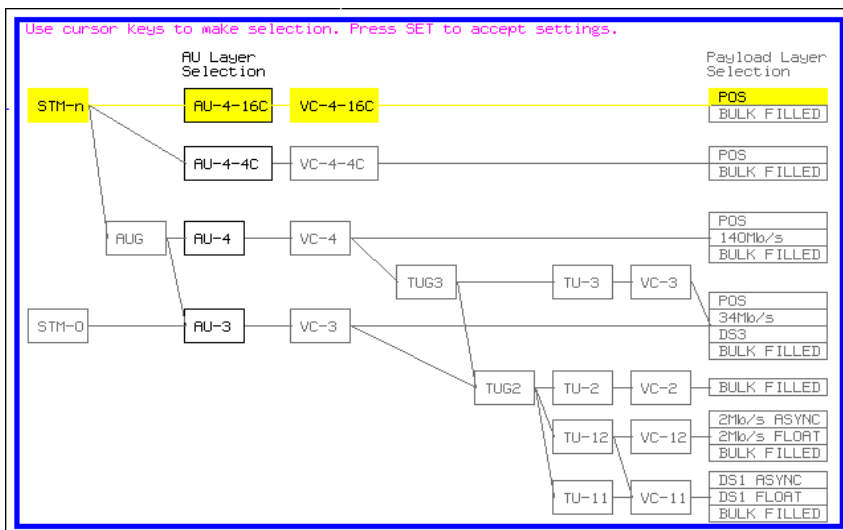

Use **→** and **←** to move between AU Layer Selection and Payload Layer Selection. Use **↑** and **↓** to set the mapping and **SET** to set your selection.

- 7 Select the STM-n channel under test.
- 8 Select the **POS SETTINGS** page and set up as described in the following pages:

Setting HDLC Framing, Scrambling and HDLC Frame Check Sequence

Description

PPP in HDLC-like framing

PPP encapsulated packets are mapped into frames. HDLC-like framing is used to delineate the packet boundaries so that the receiver can extract them from the SONET/SDH frame. Gaps between packets are filled with standard HDLC flags of 7E.

Two framing formats are provided.

- PPP in HDLC framing - as per RFC 1662.
- CISCO HDLC - Cisco's proprietary frame structure.

The HDLC-like frame includes address, control, and protocol fields followed by the IP datagram.

The frame structure is common to both formats, with values shown below.

Table 6 Frame Structure for PPP in HDLC and Cisco HDLC

Flag	Address	Control	Protocol	IP datagram	FCS	Flag
8 bits	8 bits	8 bits	16 bits	variable	16/32 bits	8 bits

PPP in HDLC	0x7E	0xFF	0x03	0x0021			0x7E
Cisco HDLC	0x7E	0x0F	0x00	0x0800			0x7E

Packet over SDH (POS)

Setting HDLC Framing, Scrambling and HDLC Frame Check Sequence

Scrambling

The purpose of POS scrambling is to ensure that malicious users cannot bring down a network by transmitting patterns which disrupt/confuse SONET/SDH synchronization or framing. See Packet over SONET/SDH white paper (on your OmniBER CD-ROM) for more details.

The addition of payload scrambling occurs when inserting the HDLC-like framed PPP packets into the SONET/SDH frame

Frame Check Sequence

The FCS (Frame Check Sequence) is a CRC checksum and is used to protect the entire frame and give an indication of traffic integrity.

The FCS value is calculated over all bits of the address, control, protocol, datagram and padding fields. It does not include the flag fields or the FCS field itself.

How To

- 1 This procedure assumes you have already selected a POS payload on the MAIN SETTING page, see “Setting up the Transmitter for POS Payloads” page 185.
- 2 Select the **POS SETTINGS** folder as shown below:

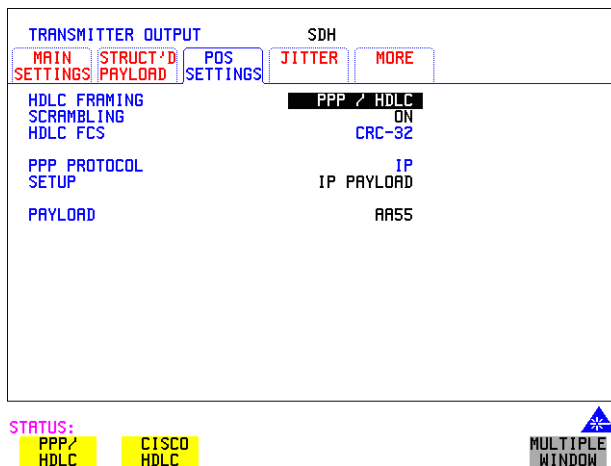

- 3 Set the HDLC FRAMING field to **PPP/HDLC** or **CISCO HDLC** as required.

Packet over SDH (POS)

Setting HDLC Framing, Scrambling and HDLC Frame Check Sequence

- 4 Set SCRAMBLING to **ON** or **OFF** as required.

If you select **ON** then scrambling is performed during insertion into the SONET using an $x^{43} + 1$ polynomial.

Note that the Scrambling OFF/ON selection affects the value of the C2 Overhead Byte as follows:

- Path Signal Label C2 set to 0x16 to indicate PPP when Scrambling set ON.
 - Path Signal Label C2 set to 0xCF to indicate PPP when Scrambling set OFF.
- 5 Set the HDLC FCS (Frame Check Sequence) field to **CRC-16** or **CRC-32** as required. Note that **CRC-16** is not available for VC4-16c at 2.5Gb/s. CRC-32 is usually the recommended selection.

Setting IP Packet (Datagram) Length and Inter-Packet Gap

Description

Both the IP datagram length and the Inter-packet gap are settable

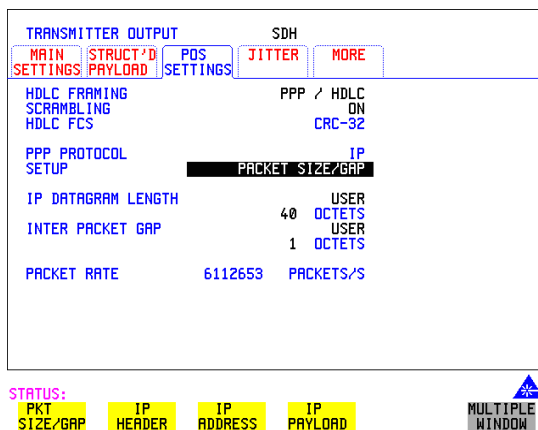

How To

- 1 This procedure assumes you have already selected a POS payload on the MAIN SETTING page, see “Setting up the Transmitter for POS Payloads” page 185.
- 2 Select the **POS SETTINGS** folder as shown above.
- 3 Set the SETUP field to **PACKET SIZE/GAP** .

IP Datagram Length

- 4 Select the IP DATAGRAM LENGTH field.
- 5 Choose the IP DATAGRAM LENGTH. There is a choice of: **USER** , **RANDOM** or **7:4:1** .

Note: The IP datagram length is the value placed in the IP header ‘Total Length’ field. No padding is implemented: the datagram is immediately followed by the end of the HDLC frame (FCS and closing flag).

User Length:

Settable between 20 and 65535 octets. Step size 1 octet. This is the size of the entire datagram, including the 20 octet header, before any HDLC octet stuffing. When the size is set to 20 only a header is transmitted.

Packet over SDH (POS)

Setting IP Packet (Datagram) Length and Inter-Packet Gap

Random Lengths: The IP datagram size is varied randomly between minimum & maximum limits.

The minimum datagram size is settable between 20 and 63 octets.

The maximum datagram size can be set to one of the following values:

- 127
- 511
- 1023
- 8191
- 65535

7,4,1 Lengths: Emulates real traffic patterns by sending a repeating sequence of 12 packets in which 7 have size 40 octets, 4 have size 552 octets, and 1 has size 1500 octets.

Setting Inter-Packet Gap

6 Choose the INTER PACKET GAP required, you can select either **USER** or **RANDOM**.

USER: Settable between 1 to $2^{30} - 1$ octets. Step size: 1 octet.

RANDOM: The Inter-packet gap is varied randomly between minimum & maximum limits.

The minimum Inter-packet gap is fixed at 1.

The maximum Inter-packet gap size can be set to one of the following values:

- 4
- 32
- 1024
- 2^{20}
- $2^{30} - 1$

Packet Rate

The PACKET RATE displayed at the bottom of the display is the number of packets per second and is determined by the following:

- Channel Bandwidth (STM-0e/STM-1/STM-4/STM-16).
- Packet (datagram) size.
- HDLC byte stuffing.
- Inter - packet gap

Please refer to “What determines the packet rate?” page 209 for a detailed description on how Packet Rate is calculated.

Setting IP Header

Setting IP Header

Description

Note the IP Header is sent in every packet.

How To

- 1 This procedure assumes you have already selected a POS payload on the MAIN SETTING page, see “Setting up the Transmitter for POS Payloads” page 185.
- 2 Select the **POS SETTINGS** folder as shown below:
- 3 Set the SETUP field to **IP HEADER** .

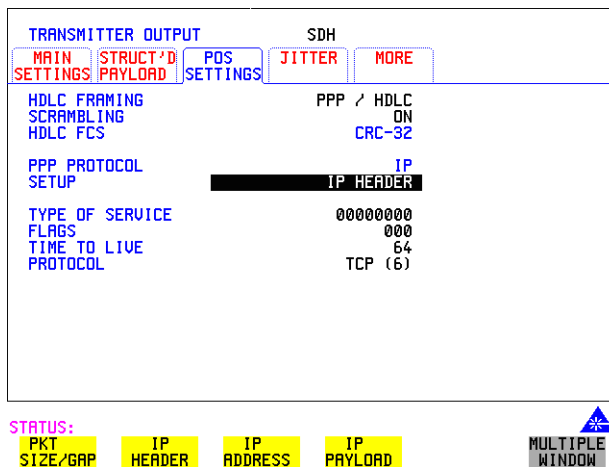

- 4 Select the TYPE OF SERVICE field and set up the 8 bits as required. This field is used to specify the service precedence of datagrams during their transmission through the internet system.
- 5 Select the FLAGS field to control fragmentation of packets and using the edit keys set each flag to 0 or 1.
- 6 Select the TIME TO LIVE field and select a value from 0 to 255 (instrument default value is 64). Each Router will decrement the TTL value as it passes through. When it reaches zero the packet is destroyed.
- 7 Select the PROTOCOL field and choose from the following preset values: ICMP (1), IP (4), TCP (6), UDP (17), ICMP or program the USER PROGRAM value (0 to 255). The instrument default choice is TCP. This field indicates the next level protocol used in the data portion of the internet datagram (the value in brackets indicates the value of the byte in decimal (i.e. (6) indicates binary 00000110).

Setting IP Addresses

How To

- 1 This procedure assumes you have already selected a POS payload on the MAIN SETTING page, see “Setting up the Transmitter for POS Payloads” page 185.
- 2 Select the **POS SETTINGS** folder as shown below:

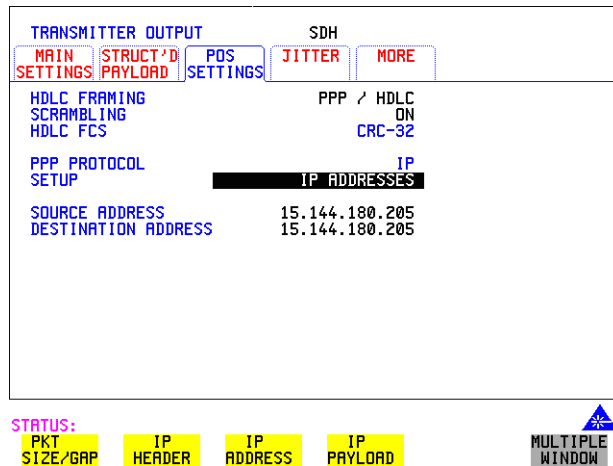

- 3 Set the SETUP field to **IP ADDRESS** and set up the Source and Destination Addresses.

Setting IP Payload

Setting IP Payload

How To

- 1 This procedure assumes you have already selected a POS payload on the MAIN SETTING page, see “Setting up the Transmitter for POS Payloads” page 185.
- 2 Select the **POS SETTINGS** folder as shown below.

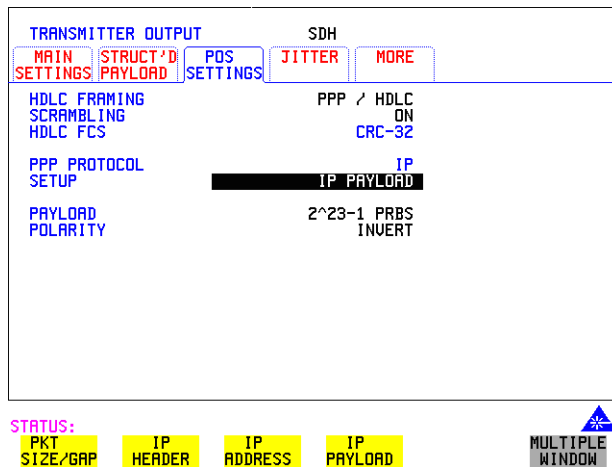

- 3 Set the SETUP field to **IP PAYLOAD**.

The IP Payload selections offered are:

- $2^{23}-1$ PRBS. (The PRBS can be non-inverted or inverted.)
 - All Ones.
 - All Zeros.
 - 0xAA55 pattern
 - 16-bit or 32 bit (BIN or HEX) user selectable word.
- 4 Set the PAYLOAD FIELD as required. Note that your choice of payload can affect the stability of the Packet Rate value (due to HDLC stuffing). To eliminate any uncertainty due to stuffing you should choose carefully the IP header and payload so that no stuffing takes place. Selecting a fixed word instead of a PRBS is recommended.

Adding POS Alarms

Description

In the OmniBER receiver the front panel HDLC LOSS LED illuminates whenever there are no valid HDLC frames and no HDLC flags. The HDLC LINK LOSS alarm provided here allows you to simulate the condition when no valid HDLC frames/flags are present.

How To

- 1 This procedure assumes you have already selected a POS payload on the MAIN SETTING page, see “Setting up the Transmitter for POS Payloads” page 185
- 2 Press the **TRANSMIT** key and select **SDH**.
- 3 Select the **TEST FUNCTION** folder as shown.
- 4 Set the TEST FUNCTION field to POS.
- 5 Set the ALARM TYPE field to **OFF** or **LINK LOSS**.
Selecting **LINK LOSS** logically inverts the 7E hex flag by transmitting the value 0x81 in all octets.

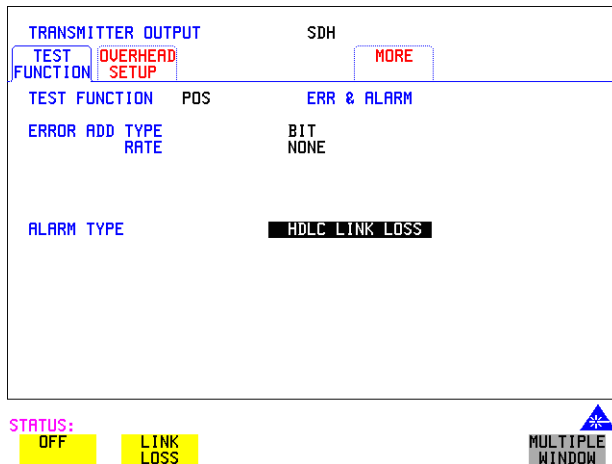

Adding POS Errors

How To

- 1 This procedure assumes you have already selected a POS payload on the MAIN SETTING page, see “Setting up the Transmitter for POS Payloads” page 185
- 2 Press the **TRANSMIT** key and select **SDH**.
- 3 Select the **TEST FUNCTION** folder as shown:
- 4 Set the TEST FUNCTION field to **POS**.

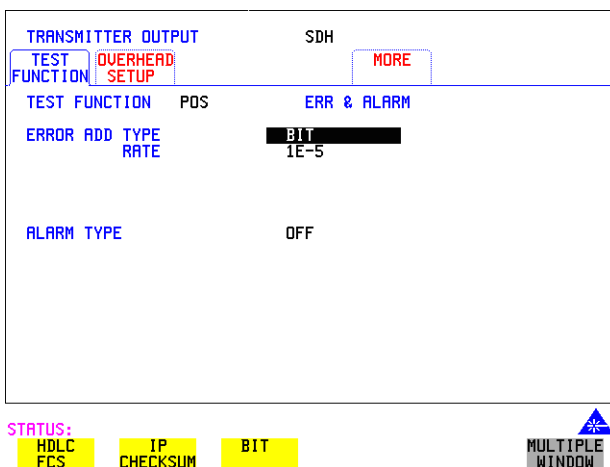

- 5 Select the ERROR ADD TYPE field and choose an Error Type, also select the Error Rate. The Error Add Types and Rates available are as follows:
 - HDLC FCS (CRC-16/CRC-32) errors.
Mode: Single (via front panel SINGLE key) or Rate (1E-3).
 - IP Header CHECKSUM Errors.
Mode: Single or Rate (1E-3).
 - BIT (IP Data) Errors
Mode:- Single or Rate
Rate = 1E-n where n= 3 to 9
Note: BIT is disabled when IP datagram length is set to 20 octets (Header only).

Packet over SDH (POS)
Setting up the Receiver for POS Operation

Setting up the Receiver for POS Operation

Description

The receiver rate and mapping can be set up to match the requirements of the equipment under test. For SDH, select a rate from STM-0 to STM-16 Optical.

TIP

To set the Transmitter and Receiver to the same interface settings choose **OTHER SETTINGS CONTROL COUPLED**. This causes the receiver to be configured to the same settings as the transmitter.

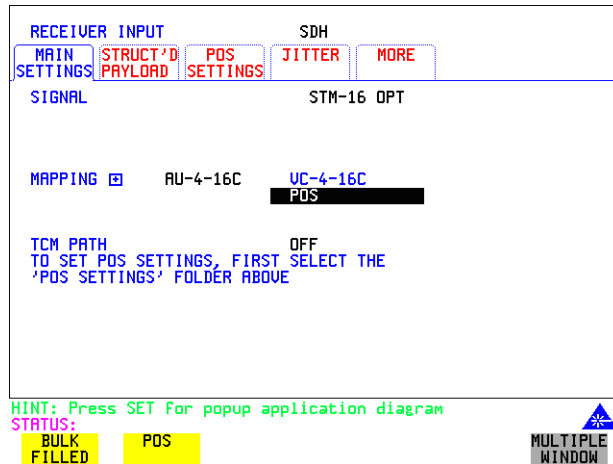

How To

- 1 Press **RECEIVE** and select **SDH**.
- 2 Select the **MAIN SETTINGS** folder.
- 3 Select the SIGNAL rate.
- 4 Select required MAPPING with POS as a payload.
As an alternative, use **SET** to bring up the popup application diagram. Use the cursor keys to navigate through the popup application diagram (see next page).

Packet over SDH (POS)

Setting up the Receiver for POS Operation

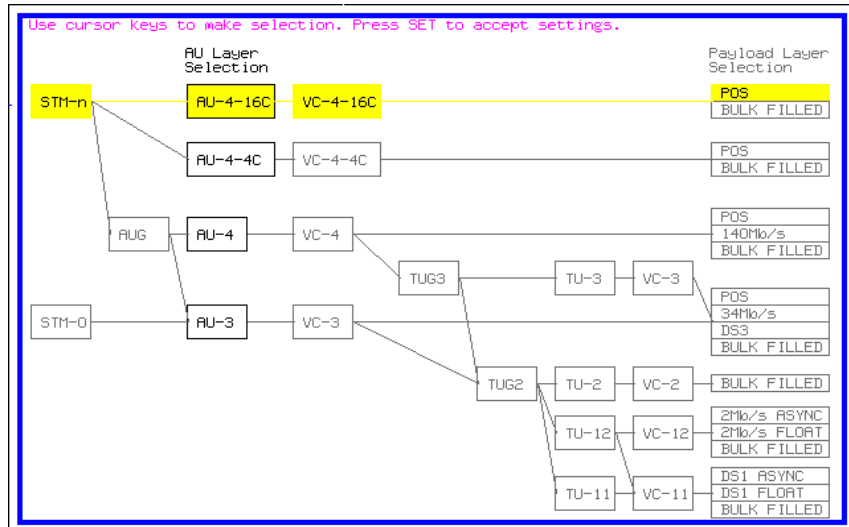

STATUS:



- 5 Continue to the next task “Setting up the Receiver POS signal” page 199 for advice on setting up the receiver POS signal.

Packet over SDH (POS)
Setting up the Receiver POS signal

Setting up the Receiver POS signal

Description

You can set up the POS receiver signal to suit the equipment under test.

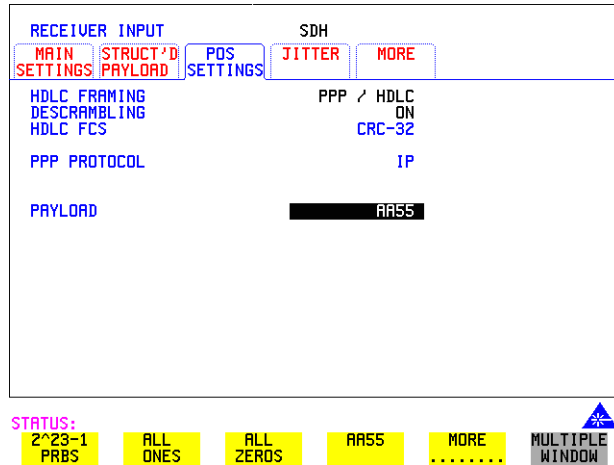

How To

- 1 Select the Receive rate and mapping, see "Setting up the Receiver for POS Operation " page 197.
- 2 Select the **POS SETTINGS** folder.
- 3 Set HDLC FRAMING to **PPP/HDLC** or **CISCO HDLC** as required.
- 4 Set DESCRAMBLING to **ON** or **OFF**.
- 5 Set HDLC FCS field to **CRC-16** or **CRC-32**.
- 6 Set the PAYLOAD field to one of the following:
 - **2²³-1 PRBS**
 - **ALL ONES**
 - **ALL ZEROS**
 - **AA55**
 - **USER WORD**
 - **LIVE TRAFFIC**

Viewing POS Results

Description

The POS results can be viewed in a variety of ways on the RESULTS page.

The screenshot shows a terminal window with the following content:

```
RESULTS  POS PAYLOAD  RESULT SUMMARY
RESULT TYPE                COUNTS

HDLC FRAMES                6.418E+07
HDLC FCS ERRORS            0

IP DATAGRAMS              6.418E+07
IP HEADER ERRORS          0
BIT ERRORS                 102693

ELAPSED TIME                00d 00h 00m 10s
```

Below the table, there is a STATUS line with several menu options:

```
STATUS:
TROUBLE SCAN  TIMING CONTROL  SDH RESULTS  POS PAYLOAD  MORE  MULTIPLE WINDOW
```

How To

- 1 Press the **RESULTS** key.
- 2 Select **POS PAYLOAD** in the RESULTS field.
- 3 **RESULT SUMMARY** gives a summary of all possible POS measurements and errors/counts and can be set up to be read as counts (total in measurement interval) or ratios/rates.
- 4 **CUMULATIVE** errors give the number of errors and counts which have occurred in total since the last time **RUN/STOP** was pressed.
- 5 **SHORT TERM** errors give the number of errors and counts which have occurred in the last measurement interval. This measurement interval is set up on the results page when **TIMING CONTROL** has been selected in the RESULTS field.
- 6 **ALARM SECONDS** is used to look at POS alarms.

Packet over SDH (POS)

POS Applications

POS Applications

The following pages give typical test applications.

Channelized Testing

Channelized Testing

Description

Channelized testing is the ability to perform tests on individual channels within SDH.

Many L1/L2 chipsets and line cards support SDH channelization. Typical configurations are:

- 3 AU3 channels in an STM-1 OPT
- 4 AU-4 channels in an STM-4 OPT
- 4 AU-4-4c channels in an STM-16 OPT
- 16 AU-4 channels in an STM-16 OPT.

An important feature of the OmniBER is the ability to perform channelized testing using a POS payload.

With the OmniBER you can perform tests either in a single channel (with the other channels filled with a background payload) or over the full SDH bandwidth (concatenated mode).

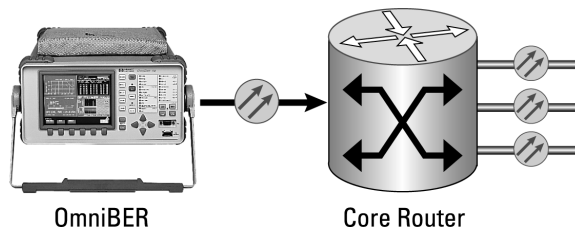

How to

- 1 Set the Transmitter and Receiver to the same interface settings by choosing **OTHER** **SETTINGS CONTROL** **COUPLED**. This causes the receiver to be configured to the same settings as the transmitter.
- 2 Press the **TRANSMIT** key and select **SDH**.
- 3 Select the **MAIN SETTINGS** folder.
- 4 Select the SIGNAL rate, CLOCK and FREQUENCY OFFSET as required.

Packet over SDH (POS)

Channelized Testing

- 5 Select required MAPPING with POS as a payload.
Use **SET** to bring up the popup application diagram. This allows an alternative way of selecting the appropriate mapping. Use the cursor keys to navigate through the popup application diagram.
- 6 Select the channel under test.
The figure below gives an example where the channel under test is STM-1(9) in an STM-16 signal.

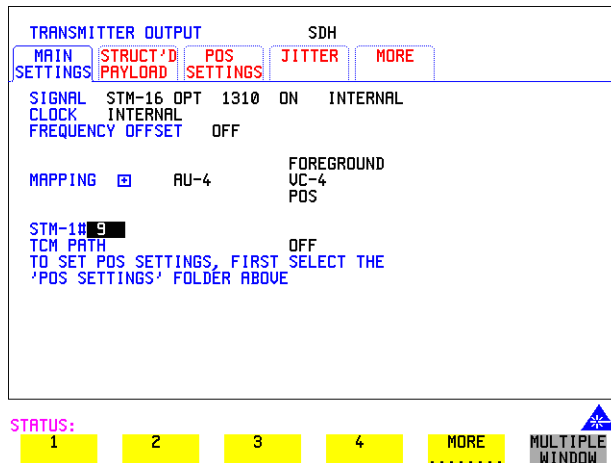

Fully Exercising POS Hardware Architecture

Description

POS hardware operating at high speeds uses wide bus architectures (that is, internal buses which are several bytes wide). To ensure correct operation the hardware needs to be fully exercised (stressed) so that all 'corner cases' are caught. This is done by generating traffic with varying packet and gap sizes, sending the smallest packets at highest speed, longest packets, scrambling and exercise of the octet stuffing and destuffing. It may also include sending packet sizes rarely encountered in live networks (such as packet sizes which are not rounded to 4-byte boundaries).

With the OmniBER 718 you generate traffic profiles to successfully exercise POS hardware using the methods described. The following figure illustrates the traffic profiles offered in the OmniBER 718.

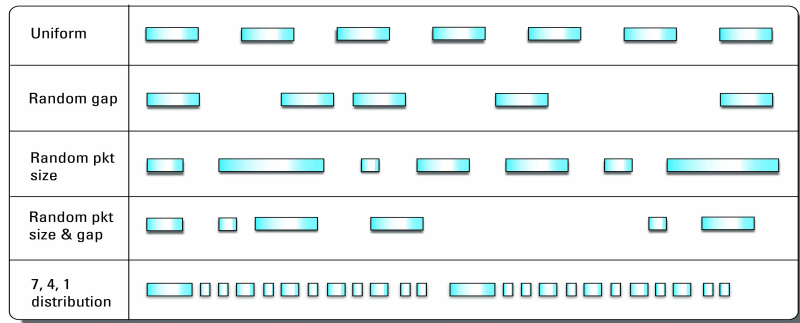

Fixed packet size and gap

If you select a fixed packet and gap you can check different phases of the wide-bus architecture. For example selecting gap sizes of 1, 2, 3 and 4 will test all 4 byte phases of a 4-byte architecture.

Random packet size

With random packet sizes, the maximum and minimum size can be set.

Packet over SDH (POS) Fully Exercising POS Hardware Architecture

Minimum sizes are particularly important for stress testing hardware. This minimum size can be set equal to the minimum allowed by the hardware.

The probability of a packet with a particular size (between max and min.) is roughly equal for all packet sizes (see following figure).

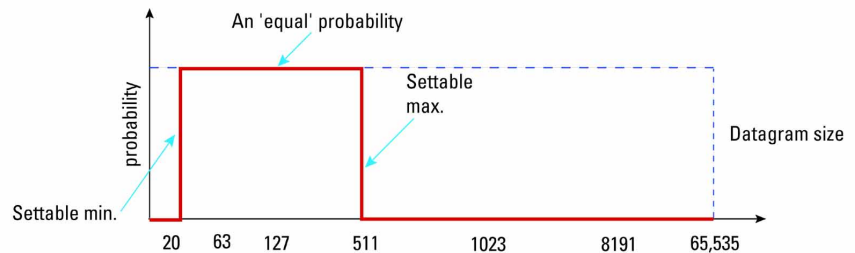

Random packet gap

Random packet gaps can be generated with roughly equal probability between 1 octet and maximum. Setting a lower maximum value will increase the average packet rate.

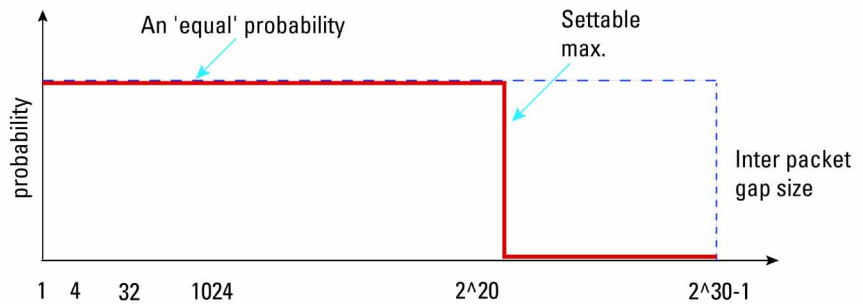

Packet over SDH (POS) Fully Exercising POS Hardware Architecture

Transmit an IP packet that generates maximum stress on the circuit under test.

An ideal way to generate the maximum stress on circuits under test is to transmit an IP packet which has both a random packet size and gap. You can do this with the OmniBER, and an example is given below.

How To

- 1 This procedure assumes you have already selected a POS payload on the MAIN SETTING page, see “Setting up the Transmitter for POS Payloads” page 185.
- 2 Select the **POS SETTINGS** folder.
- 3 Set up the POS SETTINGS page, an example is given below.

TRANSMITTER OUTPUT		SDH	
MAIN SETTINGS	STRUCT'D PAYLOAD	POS SETTINGS	JITTER MORE
HDLC FRAMING		PPP / HDLC	
SCRAMBLING		ON	
HDLC FCS		CRC-32	
PPP PROTOCOL SETUP		IP	
IP DATAGRAM LENGTH		PACKET SIZE/GAP	
RANGE FROM 20	TO 8191	RANDOM	
INTER PACKET GAP		RANDOM	
RANGE FROM 1	TO 4	OCTETS	
PACKET RATE	72275	PACKETS/S	

STATUS:
USER LENGTH RANDOM LENGTHS 7:4:1 LENGTHS

MULTIPLE WINDOW

Packet over SDH (POS)
Fully Exercising POS Hardware Architecture

Transmit IP data that more closely resembles real traffic (7:4:1 distribution)

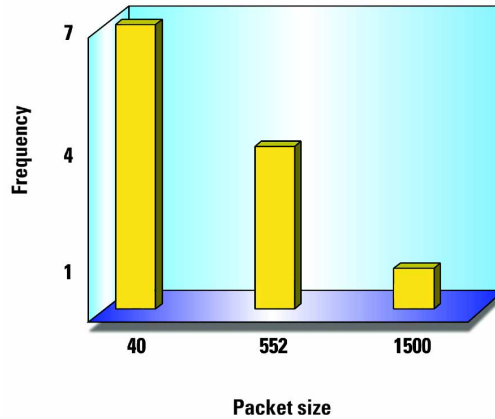

With internet traffic any of the definable packet sizes (and gaps) may be transmitted. In practise it is more common to see fewer variations in the packet size the more packets there are transmitted. The OmniBER 718 provides a packet stream that closely approximates to this type of distribution, there are three packet sizes; they are 1500, 552 and 40 octets (see Figure above). The distribution is 7 small packets (40), 4 medium sized packets (552) and 1 big packet (1500) in every group of 12.

TRANSMITTER OUTPUT		SDH	
MAIN SETTINGS	STRUCT'D PAYLOAD	POS SETTINGS	JITTER MORE
HDLC FRAMING		PPP / HDLC	
SCRAMBLING		ON	
HDLC FCS		CRC-32	
PPP PROTOCOL SETUP		IP	
IP DATAGRAM LENGTH		PACKET SIZE/GAP	
		7:4:1	
INTER PACKET GAP		RANDOM	
RANGE FROM 1 TO 4		OCTETS	
PACKET RATE		867415 PACKETS/S	

STATUS:
 USER LENGTH RANDOM LENGTHS 7:4:1 LENGTHS



Throughput Testing

Throughput Testing

Description

Packet over SDH chipsets and line cards will have performance limits imposed by the hardware architecture and by the size and management of buffers. To test these components it will be necessary to check that IP packets can be passed at the following:

- Minimum packet size and/or
- Maximum packet rate.

Using the OmniBER you can generate a continuous stream of packets of any size, and with any inter-packet gap.

In the following example the OmniBER is set up to generate a packet stream of 75-byte IP packets with a 17-byte gap between packets. The instrument displays (at the bottom of the screen) the actual transmitted packet rate in packets/s (2995200). To obtain the desired packet rate it is necessary to understand the factors determining packet rate, this is explained in the following text.

The screenshot shows the 'TRANSMITTER OUTPUT' menu for 'SDH'. The 'STRUCT'D PAYLOAD' option is selected. The configuration includes:

- HDLC FRAMING: ON
- SCRAMBLING: ON
- HDLC FCS: CRC-32
- PPP / HDLC: ON
- PPP PROTOCOL SETUP: IP
- IP DATAGRAM LENGTH: 75 OCTETS
- INTER PACKET GAP: 17 OCTETS
- PACKET RATE: 2995200 PACKETS/S

At the bottom, the 'STATUS' section shows 'PKT SIZE/GAP' as 75/17, and 'IP ADDRESS' and 'IP PAYLOAD' are also visible. A 'MULTIPLE WINDOW' icon is present in the bottom right corner.

Packet over SDH (POS)

Throughput Testing

What determines the packet rate?

- Channel bandwidth (STM-0e/STM-1/STM-4/STM-16).
- Packet size.
- HDLC byte stuffing.
- Inter packet gap.

Available bandwidth

The available bandwidth (in bytes/second) for packet transmission for each channel is as follows:

- AU-3 6048000
- AU4 18720000
- AU-4-4C 74880000
- AU-4-16C 299520000

Packet Size

For IP, the packet size is specified in terms of the IP datagram size including the 20 byte IP header. The actual packet size transmitted includes 4 bytes of PPP/HDLC overhead plus the FCS (HDLC Frame Check Sum) which is 2 bytes for FCS16 or 4 bytes for FCS32. Hence, for a 75 byte IP datagram with FCS32 the actual packet size is $75 + 4 + 4 = 83$ bytes.

The packet size may be further modified by HDLC stuffing. This will add one extra byte every time the flag (7E) or escape (7D) octet appears in the packet.

The actual transmitted packet rate (in packets/second) will then be:

channel bandwidth \div (packet size (including overhead and stuffing) + gap size).

For our example (see display on previous page), ignoring the effect of HDLC byte stuffing, we would expect a packet rate of $299520000 \div (83 + 17) = 2995200$ pkts/sec. However, due to the effects of HDLC stuffing, this figure may be slightly reduced. To eliminate the uncertainty due to stuffing, it is possible to choose carefully the IP header and payload so that no stuffing takes place. The procedure given on the next page shows how this can be done:

Packet over SDH (POS)

Throughput Testing

To Transmit a packet rate of 2995200 packets/second

The following procedure shows how to set up the OmniBER to generate a packet stream of 75-byte IP packets with a 17-byte gap between packets and with a packet rate of 2995200 packets/s.

How To

- 1 Press the **TRANSMIT** key and select **SDH**.
- 2 Select the **MAIN SETTINGS** folder and set up the page as shown below, with a POS payload selected.

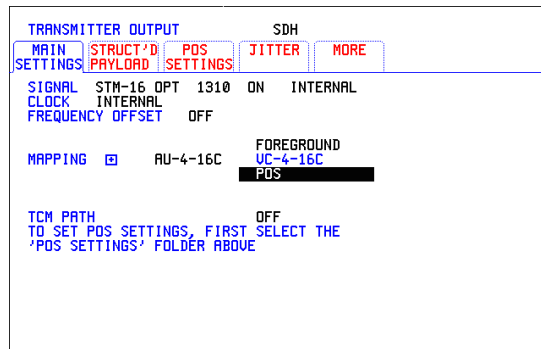

HINT: Press SET for popup application diagram

STATUS:
BULK FILLED

POS

MULTIPLE WINDOW

- 3 Select the **POS SETTINGS** folder.
- 4 Set the SETUP field to **IP PAYLOAD**.
- 5 Select a fixed word pattern as the payload (AA55 for this example).

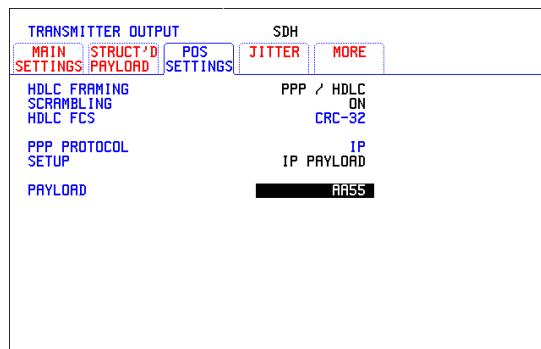

STATUS:

2^23-1 PRBS

ALL ONES

ALL ZEROS

AA55

USER WORD

MULTIPLE WINDOW

Packet over SDH (POS)

Throughput Testing

- 6 Set the SETUP field to **PACKET SIZE/GAP** .
- 7 Set the IP datagram length and inter packet gap as shown below.

TRANSMITTER OUTPUT		SDH	
MAIN SETTINGS	STRUCT'D PAYLOAD	POS SETTINGS	JITTER MORE
HDLC FRAMING		PPP / HDLC	ON
SCRAMBLING			
HDLC FCS		CRC-32	
PPP PROTOCOL		IP	
SETUP		PACKET SIZE/GAP	
IP DATAGRAM LENGTH		75	USER OCTETS
INTER PACKET GAP		17	USER OCTETS
PACKET RATE		2995200	PACKETS/S

STATUS:

PKT
SIZE/GAP

IP
HEADER

IP
ADDRESS

IP
PAYLOAD

MULTIPLE
WINDOW

Note the PACKETS/S rate displayed is what we expected (2995200).

If however you are setting up the transmitter to transmit a different packet rate and the value displayed is not what you expect, you may need to vary the word pattern (IP payload) and/or the IP datagram header bytes until the expected packet rate is displayed.

Continuity Test

Description

A continuity check is a simple and effective way of checking for missing packets or corrupted packets that are dropped. The method used is to transmit a PRBS in the POS payload part of all the IP packets and check that the PRBS arrives at the receiving port error free. A lost or corrupted packet will result in a burst of errors at the OmniBER receiver.

The figure below illustrates a packet stream with a bit pattern running through the packets and shows that when a packet is lost pattern sync loss occurs. Pattern sync loss will result in errors which can be measured in the OmniBER.

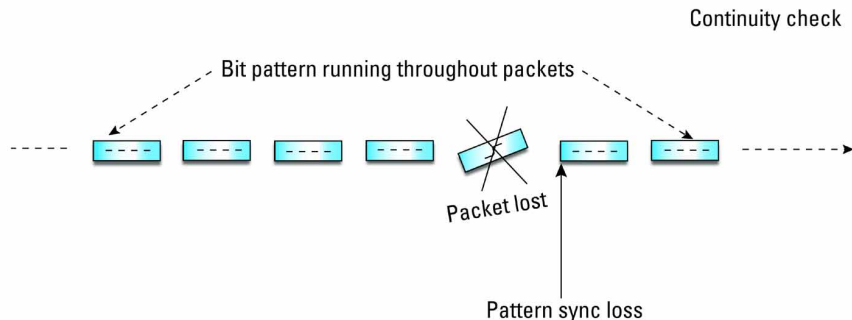

Setting up the OmniBER to perform a Continuity Test

How To

- 1 Set the Transmitter and Receiver to the same interface settings by choosing **OTHER**, **SETTINGS CONTROL**, **COUPLED**.
- 2 Press the **TRANSMIT** key and select **SDH**.
- 3 Select a POS payload on the **MAIN SETTINGS** page, see “Setting up the Transmitter for POS Payloads” page 185

Packet over SDH (POS)

Continuity Test

- 4 Select the **POS SETTINGS** folder.
- 5 Set the SETUP field to **IP PAYLOAD** and select a suitable payload, for this example we have chosen a $2^{23}-1$ PRBS as shown below.

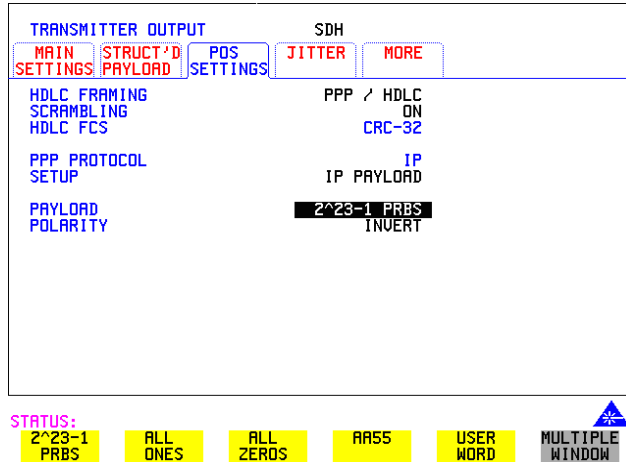

Check continuity by adding POS errors and verifying that the correct alarms and errors are received by the OmniBER.

- 6 Select the **TEST FUNCTION** folder and set up as shown below.

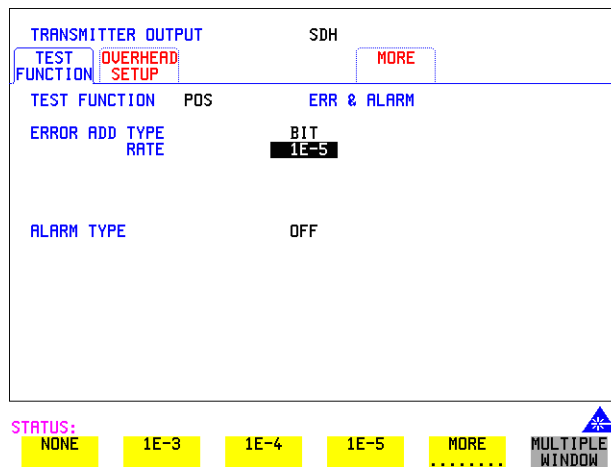

Packet over SDH (POS)

Continuity Test

- 7 Press **RUN/STOP** to start the measurement.
- 8 View the results on the **RESULTS**, **POS PAYLOAD** page. An example is given below.

TRANSMITTER OUTPUT SDH		RECEIVER INPUT SDH	
TEST FUNCTION	OVERHEAD SETUP	MAIN SETTINGS	STRUCT'D PAYLOAD
TEST FUNCTION	POS	POS SETTINGS	JITTER
ERROR ADD TYPE	ERR & ALARM	SIGNAL	
RATE	BIT 1E-5	STM-16 OPT	
ALARM TYPE	OFF	MAPPING	AU-4-16C VC-4-16C POS
		TCM PATH OFF TO SET POS SETTINGS, FIRST SELECT THE 'POS SETTINGS' FOLDER ABOVE	
RESULTS		FUNCTION SETTINGS CONTROL	
HDLG FRAMES	HDLG FCS	IP D/GRAM	IP HEADER
BIT ERRORS		TRANSMITTER AND RECEIVER COUPLED	
COUNT	13119	RECEIVER COUPLED TO TRANSMITTER	
RATIO	1.000E-05		
ELAPSED TIME	00d 00h 00m 10s		

STATUS:



In our example we introduced POS bit errors at 1E-5, this is reflected in the Results page shown in the display above.

POS Service Disruption

Description

A common feature of modern secure networks is the ability to switch the user traffic to a backup path when the main path fails, or under administrative control. This can happen at the SDH layer, or at higher protocol layers (for example MPLS). The switching will usually only disrupt the traffic briefly, and the OmniBER can measure this disruption using the method described below.

Service disruption can be measured on a POS signal on the disrupted path or virtual path.

Measurement method

The measurement is made by sending and receiving a PRBS pattern at the IP layer. The detection of a service disruption is based on the detection of bit errors on the received PRBS. The disruption period is the time from the end of a received error-free packet to the occurrence of the next error-free word (32-bits) after any bit errors have been detected. The measurement is recorded only if 200ms of no bit errors occur after the disruption period.

POS Service Disruption measurement is only available when PRBS is chosen as the payload.

Measurement accuracy

Measurement accuracy is proportional to the packet rate. The packet rate in turn is dependent on 4 factors: packet size, inter-packet gap, stuffing ratio and bandwidth (see “What determines the packet rate?” page 209).

To maximize the accuracy of this measurement, the inter-packet gap should be kept to a minimum and the packets should be kept small. However, the resulting packet rate should not exceed the specification of the system under test. The measurement accuracy is typically $\pm 2 \times (1 \div \text{packet rate})$. For example a packet rate of 10,000 packets/s gives an accuracy of typically ± 0.2 milliseconds, which is accurate enough to measure typical disruptions of many milliseconds

Hence it is only practical to approximate the accuracy. For best results, the smallest possible inter-packet gap should be chosen along with the smallest possible packet size.

Hence it is only practical to approximate the accuracy. For best results, the smallest possible inter-packet gap should be chosen along with the smallest possible packet size.

The figure on the next page illustrates the measurement technique and also shows how the packet size and rate affects the measurement accuracy.

Packet over SDH (POS) POS Service Disruption

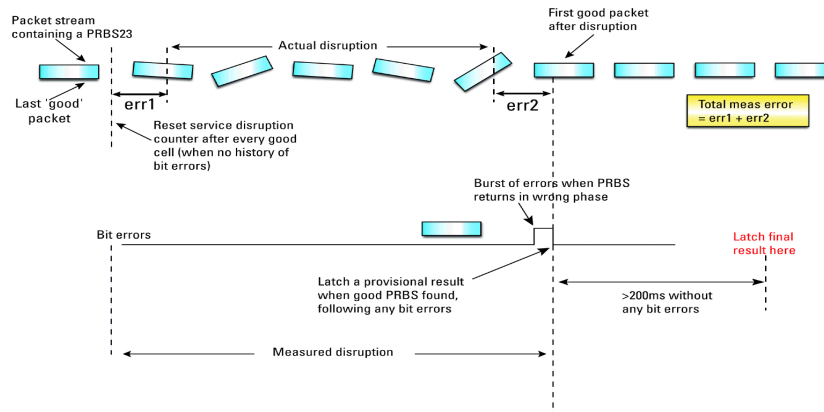

Set up the OmniBer to measure service disruption

How To

- 1 Set the Transmitter and Receiver to the same interface settings by choosing **OTHER** **SETTINGS CONTROL** **COUPLED**.
- 2 Set up the OmniBER to transmit a POS payload (see “Setting up the Transmitter for POS Payloads” page 185).
- 3 Select the **POS SETTINGS** folder.
- 4 Set the SETUP field to **IP PAYLOAD** and select **2²³-1 PRBS**.
- 5 Set the SETUP field to **PACKET SIZE/GAP** and set the IP datagram length and inter packet gap to suit your equipment under test. In the following example (on next page) we have set the datagram length and inter packet gap to give a packet rate of approximately 10,000 packets per second.

Packet over SDH (POS) POS Service Disruption

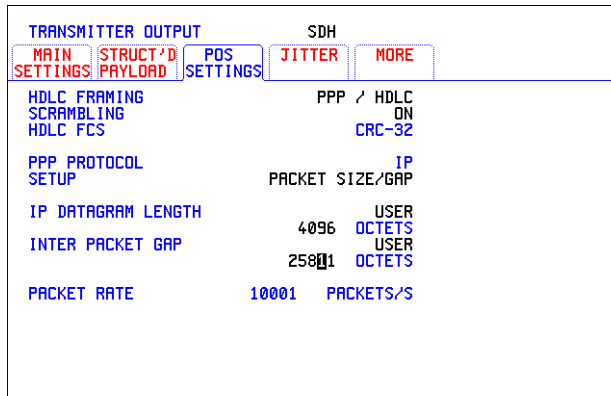

- 6 Press **RUN/STOP** to start the measurement.
- 7 Invoke the protection switch.
- 8 View the results on the **RESULTS**, **SERVICE DISRUPT** display.

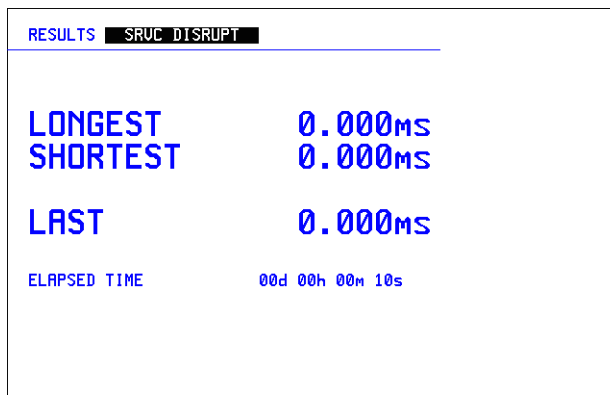

HDLC Frame Stuffing

Description

Each HDLC-like frame begins and ends with a flag sequence, which is the binary sequence 011111110 (hexadecimal 7E).

The IP data is examined on an octet by octet basis for the value 7E. If it occurs an escape sequence is used to replace any 7E octet with 7D-5E.

The 7D character is considered to be the 'escape' character so it needs to be replaced. 7D is converted to 7D-5D. The entire process is reversed at the receiver

Checking HDLC byte stuffing

To fully exercise the HDLC byte stuffing, patterns can be generated which deliberately contain a lot of stuff bytes. The IP payload can be set to a repeating 16-bit or 32-bit word pattern. Any byte of this word can be set to 7E (to emulate the flag sequence) or 7D (to emulate the escape sequence). OmniBer will 'escape' these bytes wherever they occur. For example, setting the user word pattern to 7E FF 7D FF will result in two extra escape bytes being stuffed into every 4-byte sequence during the payload.

A pattern such as 7E 7D 7D 7E will exercise the worst case stuffing rate.

Setting up the OmniBER to exercise HDLC byte stuffing

In the following example we set the PACKET SIZE/GAP to the instrument default settings (40 octet datagram length and 1 octet gap) and then select a User Word to create maximum stuffing, and note the change in Packet Rate due to stuffing.

How To

- 1 Set the Transmitter and Receiver to the same interface settings by choosing **OTHER** **SETTINGS CONTROL** **COUPLED**.
- 2 Set up the OmniBER to transmit a POS payload (see "Setting up the Transmitter for POS Payloads" page 185).
- 3 Select the **POS SETTINGS** folder.
- 4 Set the SETUP field to **IP PAYLOAD** and select **2^23-1 PRBS**.

Packet over SDH (POS)

HDLC Frame Stuffing

- Set the SETUP field to **PACKET SIZE/GAP** and set the IP datagram length and inter packet gap to suit your equipment under test. In the following example we have set the datagram length and inter packet gap to the instrument default settings (see figure below).

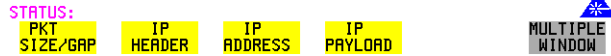
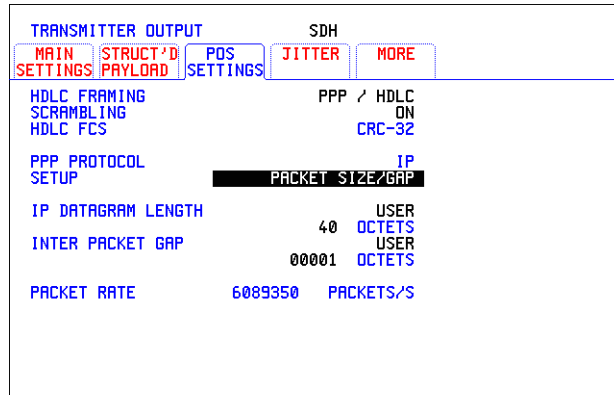

- Set the SETUP field to **IP PAYLOAD** and select **USER WORD**. Set the User Word to 32 BIT (HEX) 7E7D7D7E as shown below.

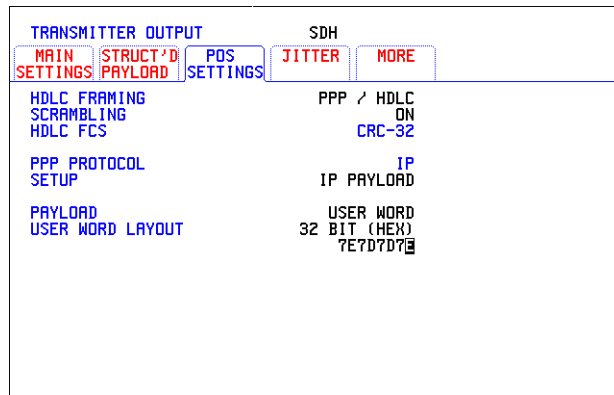

Packet over SDH (POS)

HDLC Frame Stuffing

- 7 Set the SETUP field to **PACKET SIZE/GAP** and note that the PACKET/S rate has dropped due to stuffing caused by the selection of the User Word 7E7D7E7D.

TRANSMITTER OUTPUT		SDH	
MAIN SETTINGS	STRUCT'D PAYLOAD	POS SETTINGS	JITTER MORE
HDLC FRAMING		PPP / HDLC	
SCRAMBLING		ON	
HDLC FCS		CRC-32	
PPP PROTOCOL		IP	
SETUP		PACKET SIZE/GAP	
IP DATAGRAM LENGTH		40	USER OCTETS
INTER PACKET GAP		00001	USER OCTETS
PACKET RATE		4340869	PACKETS/S

STATUS:

PKT
SIZE/GAP

IP
HEADER

IP
ADDRESS

IP
PAYLOAD

MULTIPLE
WINDOW

Jitter Tolerance Testing of POS Equipment

Jitter is present to a certain extent in all telecommunication networks, and can be defined simply as the movement in time of parts of a clock or data stream relative to where we expect to find them. Bit errors or data loss will occur in a digital signal if jitter at the input port of a network element exceeds a threshold value. It is important therefore that the network element be designed to tolerate a sufficient level of jitter, that is, does not introduce errors when certain values of jitter are present. The

ITU-T specifies the lower limit of maximum tolerable input jitter (MTIJ) in the form of an ITU-T jitter tolerance mask. The OmniBER provides a number of ITU-T masks for Jitter Tolerance testing, see “Measuring Jitter Tolerance” page 134.

Use the Jitter generation and measurement features of the OmniBER to verify the jitter tolerance of POS line cards.

Jitter/Wander Generation and Jitter Tolerance and Jitter Transfer tests are available at all SDH rates when a POS payload is selected.

Automatic Jitter Tolerance measurement is only available with a POS payload when the payload selected is 2²³-1PRBS.

Only a Jitter Tolerance example is given here, for information on Jitter Transfer and Wander measurements refer to “Measuring Jitter Transfer” page 138 and “Measuring Wander” page 131.

Jitter Tolerance method

Jitter is generated at a range of frequencies within the mask and an error measurement is made. If no errors occur (PASS), the jitter amplitude at that frequency point is increased until errors occur (FAIL) or the maximum jitter amplitude is reached. The highest jitter amplitude at which PASS occurs is plotted on the graph as the Jitter Tolerance for that jitter frequency.

User-Programmable Masks

There are 5 user programmable masks provided allowing you to create, edit and title up to 5 jitter masks. Please refer to “To Generate a New Jitter Mask” on page 299 and “To change the parameters of a User Defined Jitter Mask” on page 301 for instructions on how to generate or edit a user programmable mask.

Packet over SDH (POS) Jitter Tolerance Testing of POS Equipment

How To

Perform a Jitter Tolerance Measurement

- 1 Set up the transmitter and select a POS payload with a fixed 2²³-1 PRBS (see "Setting up the Transmitter for POS Payloads " page 185) and "Setting IP Payload" page 194.
- 2 Select the **POS SETTINGS** folder as shown below.

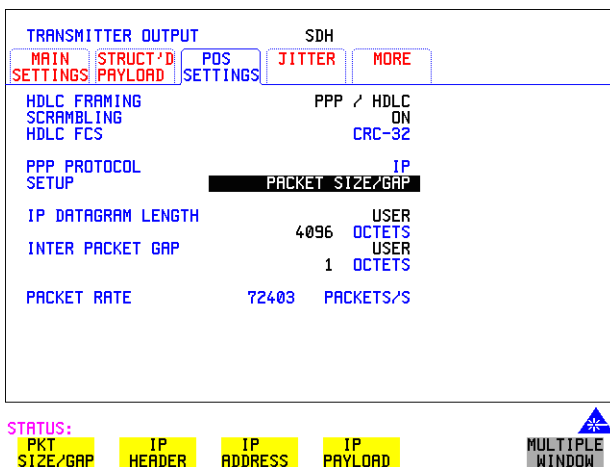

- 3 Set the SETUP field to **PACKET SIZE/GAP** and select a size as large as practical for the system under test (this gives better coverage for error detection). For this example we selected a length of 4096 and a gap of 1.
- 4 Select the IP DATAGRAM LENGTH field as required.
- 5 Set the INTER PACKET GAP as required (the smaller the better, for increased coverage).
- 6 If you are performing jitter tolerance on an SDH Optical signal, check on the **RESULTS** **SDH RESULTS** **OPTICAL POWER** display that the measured optical power level falls within the white portion of the coloured bar. This ensures the accuracy of the Jitter results.
- 7 Set up the receiver for POS operation, see "Setting up the Receiver for POS Operation" page 197 and "Setting up the Receiver POS signal" page 199. Set the receiver payload to 2²³-1PRBS

Packet over SDH (POS)

Jitter Tolerance Testing of POS Equipment

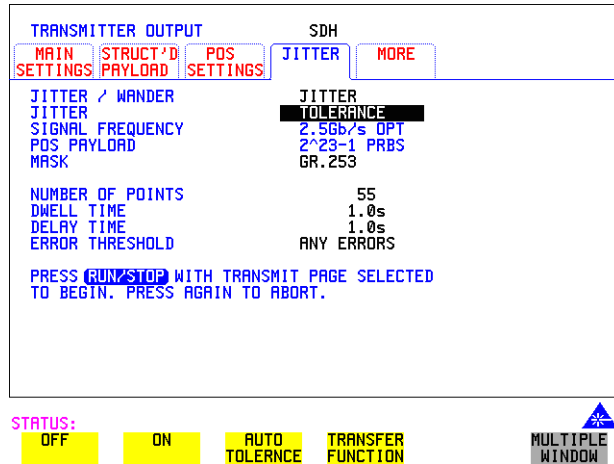

- 8 Select the **JITTER** folder and select AUTO TOLERANCE and a MASK (see display above).
- 9 Choose the NUMBER OF POINTS at which jitter is transmitted (3 to 55)
- 10 Choose the DWELL TIME - the time jitter is generated at each jitter frequency point (0.1 to 99.9 seconds).
- 11 Choose the DELAY TIME - the time delay between the jitter frequency/amplitude being applied and the error measurement being made. This allows the network equipment to settle as jitter frequency is changed. (0.1 to 99.9 seconds).
- 12 Set the ERROR THRESHOLD field to ANY ERRORS. Any BIT, BIP, FCS or header errors will result in a FAIL.
- 13 Press **RUN/STOP** to start the jitter auto tolerance measurement. The measurements progress can be monitored on the **TRANSMIT** display. At the end of the test the results can be viewed on the **TRANSMIT** or **RESULTS** displays. The **TRANSMIT** display is cleared when **TRANSMIT** is pressed but the results remain on the **RESULTS** display until the next jitter tolerance measurement is made.

Jitter Tolerance Testing of POS Equipment

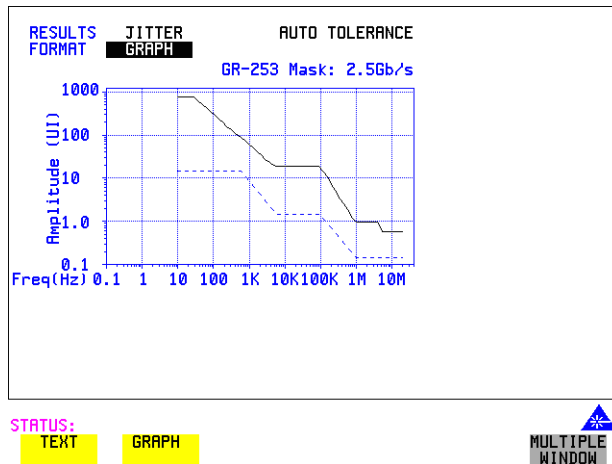

View the Results

14 Choose the results FORMAT.

If **GRAPH** is chosen, a plot of the jitter tolerance results against the ITU-T mask is displayed.

If **TEXT** is chosen, the results from which the graph is constructed are displayed, Point number, Frequency, Mask amplitude, Tolerance, Result.

If applicable, points 13 through 55 can be viewed on pages 2 through 5.

If you wish to log the jitter tolerance results to a printer, See “Logging Jitter Tolerance Results” page 264.

- “Tandem Connection Monitoring (TCM)” page 226
- “Setting up the Transmitter for TCM Operation” page 227
- “Setting up TCM Access Point Identifier (APId) messages” page 228
- “Adding TCM errors” page 230
- “Adding TCM Alarms” page 231
- “Setting up the Receiver for TCM operation” page 232
- “Detecting TCM APId messages” page 233
- “Viewing TCM Errors and Alarms” page 235
- “Tandem Connection Terminating Equipment (TCTE) Testing” page 237

Tandem Connection Monitoring

Tandem Connection Monitoring (TCM)

What is a Tandem Connection?

A tandem connection is a bi-directional connection between two TCTEs (Tandem Connection Terminating Elements) along an SDH path, which is managed as a separate entity. The tandem path is formed from an SDH Virtual Container (VC) with special monitoring signals carried in the path overhead (POH) bytes. These bytes enable monitoring of tandem paths, performance analysis and fault location - the ability to finger point.

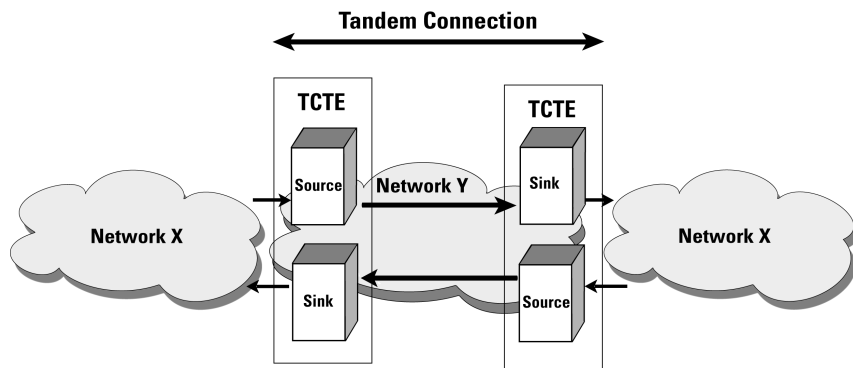

TCM Test Capability in OmniBER

The TCM test functionality in the OmniBER 718 complies with G.707 Annex D and Annex E. Features included are alarm generation and detection, error generation and detection and access point identifier generation and decode.

The functionality covers the requirements for both high order and low order paths.

High Order: VC4 →AU4 and VC3→AU3 use N1 byte.

Low Order: VC3→TU3 use N1 byte.

VC2→TU2, VC11→TU11 and VC→TU12 use N2 byte.

Setting up the Transmitter for TCM Operation

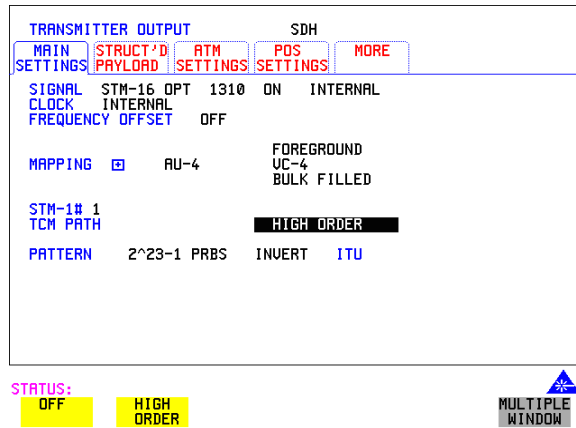

HOW TO

- 1 Press the **TRANSMIT** key and select **SDH**.
- 2 Select the **MAIN SETTINGS** folder.
- 3 Set up the Transmitter as required, see “Setting SDH Transmit Interface” page 29.
- 4 Set the TCM PATH field to **HIGH ORDER** or **LOW ORDER** as required. The LOW ORDER selection is enabled when a TU mapping is selected.

Setting up TCM Access Point Identifier (APId) messages

Description

The OmniBER offers the choice of transmitting in N1 (High Order Path or Low Order Path if TU-3) or N2 (Low Order Path) bytes the following messages:

- **DEFAULT** - A null APId message.
- **TEST** - A fixed test message “<serial number>”
- **USER** - A user definable 15 byte message followed by a one byte CRC.

The CRC is automatically calculated for all three message types.

HOWTO

- 1 Press the **TRANSMIT** key and select **SDH**.
- 2 Select the **MAIN SETTINGS** folder.
- 3 Set the TCM PATH field to **HIGH ORDER** or **LOW ORDER** as required.
- 4 Select the **OVERHEAD SETUP** folder and set up the APId messages using one of the following two methods:

Method 1:

- 5 Select the **SETUP** field and choose **TCM MESSAGE**.
- 6 Set the N1 or N2 field as required from **DEFAULT**, **TEST** or **USER**. If you select **USER**, use the edit keys at the bottom of the screen to set up your message.

Tandem Connection Monitoring Setting up TCM Access Point Identifier (APID) messages

TRANSMITTER OUTPUT			SDH
JITTER	TEST FUNCTION	OVERHEAD SETUP	MORE
SETUP TCM WITHIN STM-1# 1			
N1	APID USER	→	OMNIBER 718 001 (UC-4)

STATUS:

APID DEFAULT	APID TEST	APID USER
-----------------	--------------	--------------

MULTIPLE
WINDOW

Method 2

- Select the SETUP field and choose **POH**.
- Set the N1 or N2 field as required from DEFAULT, TEST or USER. If you select USER, use the edit keys at the bottom of the screen to set up your message.

TRANSMITTER OUTPUT			SDH
JITTER	TEST FUNCTION	OVERHEAD SETUP	MORE
SETUP POH WITHIN STM-1# 1			
		TYPE	UC-4
J1	DEFAULT	→	"XXXXXXXXXXXXXXXXXXXX XXXXXXXXXXXXXXXXXXXX XXXXXXXXXXXXXXXXXXXX XXXXXXXXXXXXXXXXXXXX"
B3	XXXXXXXXXX		
C2	11111110		
G1	00000000		
F2	00000000		
H4	00000000		
F3	00000000		
K3	00000000		
N1	XXXX00XX	→	HP PATH LABEL (C2) : 0.181 BULK FILLED APID USER OMNIBER 718 001

STATUS:

APID DEFAULT	APID TEST	APID USER
-----------------	--------------	--------------



MULTIPLE
WINDOW

Adding TCM errors

Description

The following TCM errors can be generated in the OmniBER:

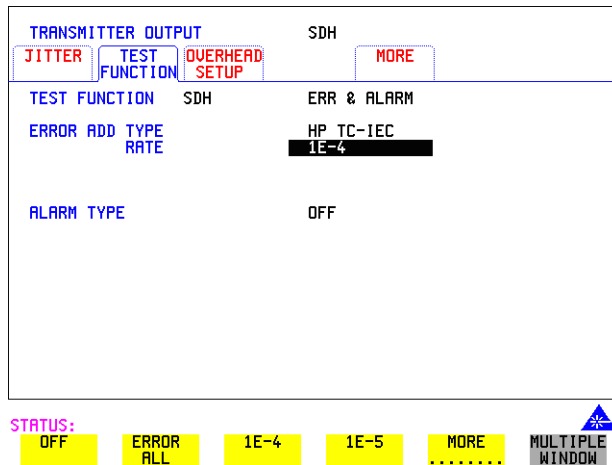
TC-IEC	Incoming Error Count (on N1 only).
TC-REI	Remote Error Indication.
OEI	Outgoing Error Indication.
TC-BIP	TC-BIP Error (on N2 only)



HOWTO

- 1 Press the **TRANSMIT** key and select **SDH**.
- 2 Select the **MAIN SETTINGS** folder.
- 3 Set the TCM PATH field to **HIGH ORDER** or **LOW ORDER** as required.
- 4 Select the **TEST FUNCTION** folder as shown above.
- 5 Set the TEST FUNCTION field to **SDH** and select **ERRORS & ALARMS**.
- 6 Select the ERROR ADD TYPE field and choose an Error Type, also select the Error Rate.

Tandem Connection Monitoring

Adding TCM Alarms

Adding TCM Alarms

Description

There are four alarms that can be generated and detected in the OmniBER, they are:

TC- LOM	Tandem Connection Loss of Multiframe.
TC-RDI	Tandem Connection Remote Defect Indicator.
TC-IAIS	Incoming AIS.
ODI	Outgoing Defect Indicator.

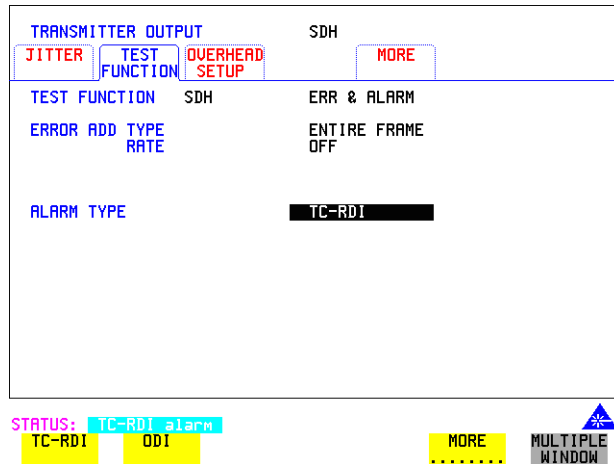

HOWTO

- 1 Press the **TRANSMIT** key and select **SDH**.
- 2 Select the **MAIN SETTINGS** folder.
- 3 Set the TCM PATH field to **HIGH ORDER** or **LOW ORDER** as required.
- 4 Select the **TEST FUNCTION** folder as shown above.
- 5 Set the TEST FUNCTION field to **SDH** and select **ERRORS & ALARMS**.
- 6 Select the ALARM TYPE field and choose an Alarm Type.

Setting up the Receiver for TCM operation

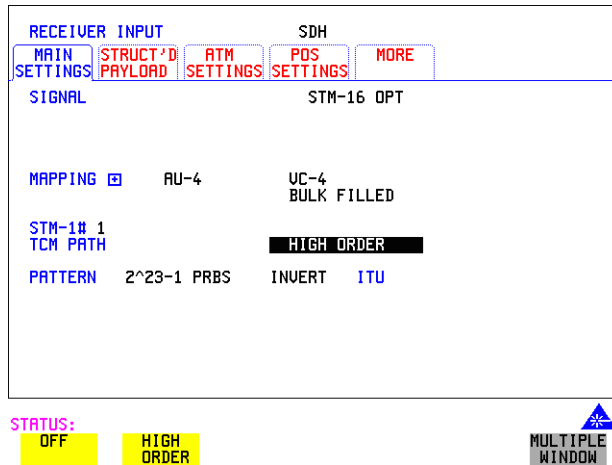

HOWTO

- 1 Press **RECEIVE** and select **SDH**.
- 2 Select the **MAIN SETTINGS** folder.
- 3 Set up the Receiver as required, see “Setting SDH Receive Interface” page 49.
- 4 Set the TCM PATH field to **HIGH ORDER** or **LOW ORDER** as required. The LOW ORDER selection is enabled when a TU mapping is selected.

Detecting TCM APId messages

Description

TCM Access Point Identifier messages are detected and displayed on the Receiver OVERHEAD MONITOR page in two places, as described below.

HOWTO

- 1 Press **RECEIVE** and select **SDH** .
- 2 Select the **MAIN SETTINGS** folder.
- 3 Set the TCM PATH field to **HIGH ORDER** or **LOW ORDER** as required.
- 4 Select the **OVERHEAD MONITOR** folder and set up the APId messages using one of the following two methods:

Method 1

- 5 Select the MONITOR field and choose **TCM MESSAGE**, see following example display.

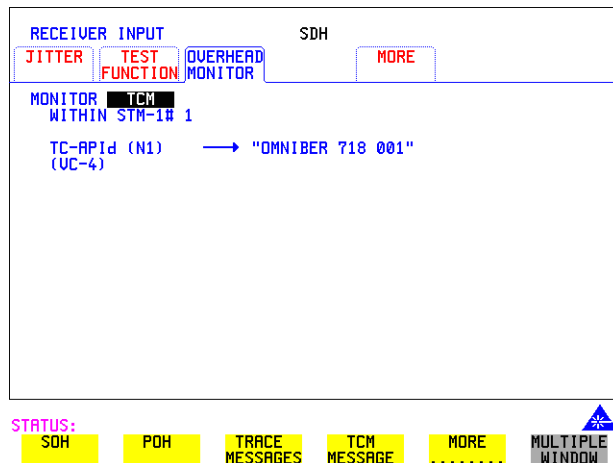

Tandem Connection Monitoring

Detecting TCM APId messages

Method 2

- 6 Select the MONITOR field and choose **POH** .
- 7 To view the the N1 byte message set the TYPE field to **VC-4** or **VC-3** as required.

RECEIVER INPUT SDH

JITTER TEST FUNCTION OVERHEAD MONITOR MORE

MONITOR POH TYPE VC-4

WITHIN STM-1# 1

J1	00000000	→	"0000000000000000"
B3	01010100	→	"0000000000000000"
C2	00000010	→	"0000000000000000"
G1	00000000	→	"0000000000000000"
F2	00000000	→	"0000000000000000"
H4	00000000	→	"0000000000000000"
F3	00000000	→	"0000000000000000"
K3	00000000	→	"0000000000000000"
N1	10010010	→	"0000000000000000"

HP PATH LABEL (C2) :
TUG STRUCTURE
→ "OMNIBER 718 001"

STATUS:
UC-4 UC-3

MULTIPLE WINDOW

- 8 To view the N2 byte message select the TYPE field and set as required.

RECEIVER INPUT SDH

JITTER TEST FUNCTION OVERHEAD MONITOR MORE

MONITOR POH TYPE VC-12

U5	01000100	→	"0000000000000000"
J2	00000000	→	"0000000000000000"
N2	01100011	→	"0000000000000000"
K4	00000000	→	"0000000000000000"

TU SIGNAL LABEL : 010 ASYNCHRONOUS

STATUS:
UC-4 UC-12

MULTIPLE WINDOW

Viewing TCM Errors and Alarms

Description

TCM error and alarm results can be viewed on the RESULTS page.

The screenshot displays the 'ERROR SUMMARY' screen. At the top, 'RESULTS SDH' is shown. Below it, a table lists error types and their counts. The 'COUNTS' column shows values like 55624 for TC-1EC and TC-ERR, and 0 for others. At the bottom, there are status indicators for 'ERROR SUMMARY', 'CUMULATIVE', 'SHORT TERM', 'ERROR ANALYSIS', 'MORE', and 'MULTIPLE WINDOW'. A small blue triangle icon is also visible.

RESULT TYPE	COUNTS
FRAME	0
B1 BIP	0
B2 BIP	0
MS-REI	0
B3 BIP	0
HP-REI	0
BIT	0
AU POINTER	0
TC-1EC	55624
TC-ERR	55624
DEI	0
TC-REI	0
TU BIP	N/A
LP-REI	N/A
TU POINTER	N/A
OPTICAL POWER dBm
ELAPSED TIME	00d 00h 00m 03s

STATUS:
ERROR SUMMARY CUMULATIVE SHORT TERM ERROR ANALYSIS MORE MULTIPLE WINDOW

HOWTO

- 1 Press the **RESULTS** key.
- 2 Select **SDH RESULTS** in the RESULTS field.
- 3 **ERROR SUMMARY** gives a summary of all possible SDH/TCM measurements and errors/counts and can be set up to be read as counts (total in measurement interval) or ratios/rates.
- 4 **CUMULATIVE** errors give the number of errors and counts which have occurred in total since the last time **RUN/STOP** was pressed.
- 5 **SHORT TERM** errors give the number of errors and counts which have occurred in the last measurement interval. This measurement interval is set up on the results page when **TIMING CONTROL** has been selected in the RESULTS field.

See next page for an example of the Alarms Results page

Tandem Connection Monitoring

Viewing TCM Errors and Alarms

- 6 Select **ALARM SECONDS** to view alarms (see below).

RESULTS SDH		ALARM SECONDS	
POWER LOSS	0	HP-RDI	0
LDS	0	H4 LOM	N/A
LDF	0	TC-LOM	0
ODF	0	TC-IRIS	0
AU-LOP	0	TC-RDI	13
MS-RIS	0	ODI	0
AU-RIS	0	TU-LOP	N/A
K1/K2 CHANGE	0	TU-RIS	N/A
MS-RDI	0	PIPO LOM	N/A
		LP-RDI	N/A
ELAPSED TIME		00d 00h 00m 13s	

STATUS: TC-RDI alarm

ALARM SECONDS	FREQ- UENCY	POINTER VALUES	POINTER GRAPH	MORE	MULTIPLE WINDOW
---------------	-------------	----------------	---------------	------------	-----------------

Tandem Connection Terminating Equipment (TCTE) Testing

TCTE Source Testing

Description

Verify that the system responds correctly when a valid SDH signal is sent, and then add errors and alarms and check again that the system responds correctly to this new stimulus. The following figure illustrates the test setup for TCTE Source testing.

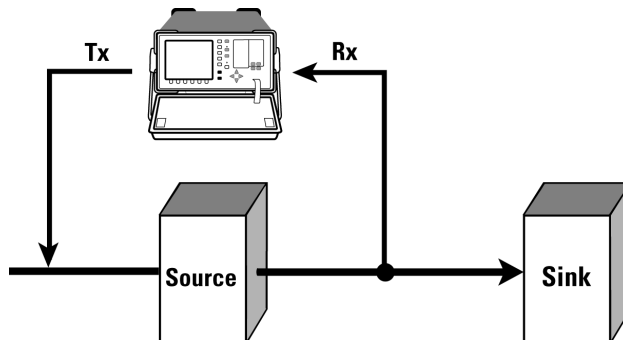

Introduction

The following procedure gives an example of testing a TCTE source which originates a VC-4 link over STM-1. In the procedure a valid SDH signal is sent from the OmniBER to the TCTE Source and the output of the Source is monitored in the OmniBER Receiver for correct TC-APId (access point identifier) and absence of alarms.

HOWTO

- 1 Connect the System under test to the OmniBER as shown above.
- 2 Press the **TRANSMIT** key and select **SDH**.
- 3 Select the **MAIN SETTINGS** folder.

Tandem Connection Monitoring

Tandem Connection Terminating Equipment (TCTE) Testing

- 4 Configure the OmniBER to send a valid VC-n to the TCTE Source. For this example we have selected VC-4 mapping over STM-1.

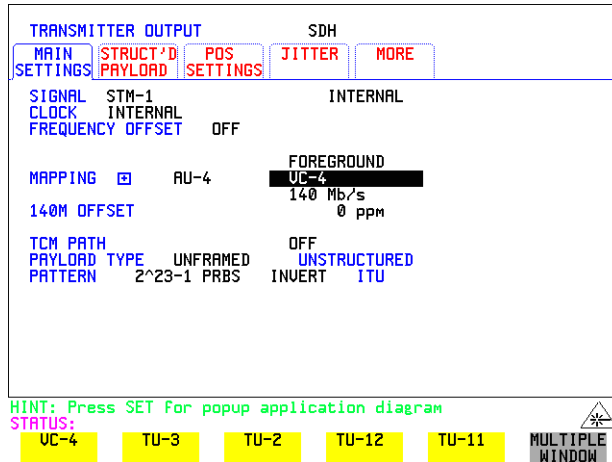

- 5 Check that there are no alarms indicated on the OmniBER front panel. If TCM is not enabled on the TCTE then the instrument STATUS line (at bottom of the display) will indicate “TCM Loss of Multiframe (TC-LOM)”, and the Alarm Seconds results on the Results page will indicate TC-LOM alarms . The absence of errors confirms that TCM is configured correctly.
- 6 Check for correct TC-APId (access point identifier) as follows:
- 7 Press **RECEIVE** and select **SDH** .
- 8 Select the **MAIN SETTINGS** folder.
- 9 Set the Receiver settings to match those of your system.
- 10 Set the TCM PATH field to **HIGH ORDER** or **LOW ORDER** . The LOW ORDER selection is enabled when a TU mapping is selected.
- 11 Select the **OVERHEAD MONITOR** folder.
- 12 Select the MONITOR field and choose **TCM MESSAGE** , check on the display that the TC-APId matches the APId as expected from the TCTE, an example is given on the following page.

Tandem Connection Monitoring

Tandem Connection Terminating Equipment (TCTE) Testing

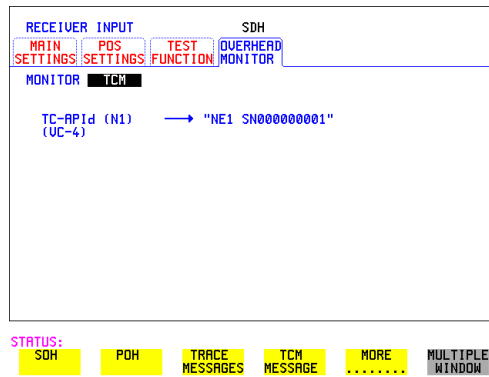

Error Monitoring Testing

Method: Use the OmniBER Transmitter to generate errors in the system under test and verify on the Receiver that the correct error result is obtained.

- 13 Press the **TRANSMIT** key and select **SDH**.
- 14 Select the **TEST FUNCTION** folder.
- 15 Set the TEST FUNCTION field to **SDH** and select **ERRORS & ALARMS**.
- 16 Select an ERROR ADD TYPE and RATE, for this example we have chosen to add B3 BIP errors at a rate of 1E-5, as shown below.

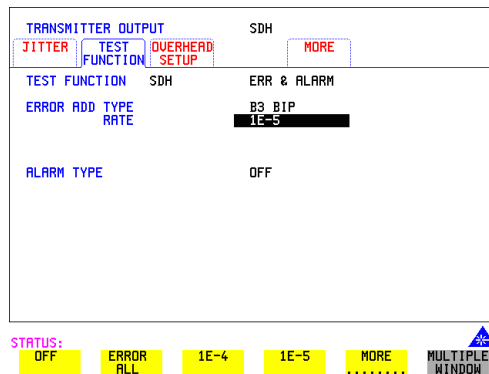

- 17 Press **RUN/STOP** to start the test. See “Test Timing” page 111 for advice on setting test periods.

Tandem Connection Monitoring

Tandem Connection Terminating Equipment (TCTE) Testing

- 18** Check that the OmniBER Receiver detects and displays a B3 BIP and TC-IEC error ratio of 1.000E-05 (for this example), see figure below.
This verifies that the Network Element has correctly copied the B3 count into bits 1-4 of the N1 byte and that B3 is correctly compensated.
- 19** To view results select **RESULTS** **SDH RESULTS** and **ERROR SUMMARY** .
- 20** Set the RESULT TYPE field to **RATIOS** .

RESULTS	SDH	ERROR SUMMARY
RESULT TYPE		RATIOS
FRAME	0	TC-IEC 1.000E-05
B1 BIP	0	TC-ERR 0
B2 BIP	0	DEI 0
MS-REI	0	TC-REI 0
B3 BIP	1.000E-05	TU BIP N/A
HP-REI	0	LP-REI N/A
BIT	N/A	
AU POINTER	0	TU POINTER N/A
OPTICAL POWER	 dBm
ELAPSED TIME		00d 00h 11m 23s

STATUS: COUNTS RATIOS

MULTIPLE WINDOW

Alarms Testing

Method: Send an invalid VC-4 to the TCTE under test and check that the OmniBER Receiver registers an TC-IAIS alarm.

- 21** Press the **TRANSMIT** key and select **SDH** .
- 22** To generate an invalid VC-n in the OmniBER select the Transmitter TEST FUNCTION folder as shown below and select a AU-LOP, LOF or MS_AIS Alarm.

TRANSMITTER OUTPUT	SDH
TEST FUNCTION OVERHEAD SETUP	MORE
TEST FUNCTION	ERR & ALARM
ERROR ADD TYPE RATE	ENTIRE FRAME OFF
ALARM TYPE	AU-LOP

STATUS: MS-AIS MS-RDI AU-LOP AU-RIS MORE

MULTIPLE WINDOW

Tandem Connection Monitoring Tandem Connection Terminating Equipment (TCTE) Testing

23 View alarms on the RESULTS folder, an example is given below:

RESULTS SDH ALARM SECONDS

POWER LOSS	0	HP-RDI	0
LDS	0	H4-LOM	N/A
LDF	0	TC-LOM	0
ODF	0	TC-IAIS	96
AU-LOP	0	TC-RDI	0
MS-AIS	0	ODI	0
AU-AIS	0	TU-LOP	N/A
K1/K2 CHANGE	0	TU-AIS	N/A
MS-RDI	0	P1P0 LOM	N/A
		LP-RDI	N/A

ELAPSED TIME 00d 00h 01m 36s

STATUS: TC-IAIS alarm

ERROR SUMMARY
CUMULATIVE
SHORT TERM
ERROR ANALYSIS
MORE
MULTIPLE WINDOW

24 Verify that the signal label (in C2 or V5) is set to all-ones, which indicates a VC-AIS.

RECEIVER INPUT SDH

TEST FUNCTION
OVERHEAD MONITOR
MORE

MONITOR POH TYPE UC-4

J1	11111111	→	"
B3	10100000		
C2	11111111		
G1	11111111		"
F2	11111111		
H4	11111111		
F3	11111111		
K3	11111111		
N1	11100000		

HP PATH LABEL (C2) :
UC-AIS (TCM)

STATUS:

SDH
POH
TRACE MESSAGES
LABELS
APS MESSAGES
MULTIPLE WINDOW

25 Press **RUN/STOP** to end the test.

Tandem Connection Monitoring
Tandem Connection Terminating Equipment (TCTE) Testing

TCTE Sink/Source Testing

Description

Connect the OmniBER to the system under test as shown below, stress the system by adding alarms and errors, and check for the correct response from the network element.

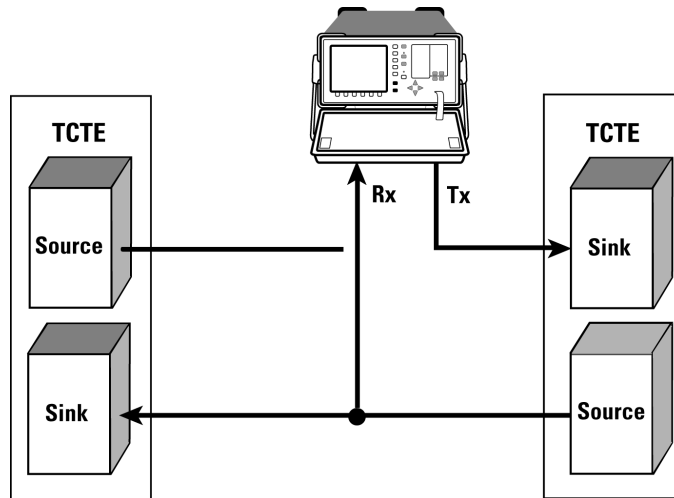

HOWTO

- 1 Add the following alarms/errors to the signal input to the TCTE Sink input and check on the OmniBER RESULTS page for the correct response.

Alarm/Errors Transmitted	Response on OmniBER Rx
No signal, loss of frame, loss of pointer.	TC-RDI and ODI alarms.
TC-APIId mismatch.	TC-RDI and ODI alarms.
TC-IAIS	ODI alarm.
BIP errors at 1E-5	OEI errors at 1E-5
BIP or IEC errors at 1E-5	TC-REI errors at 1E-5*

*Sending BIP errors without IEC errors, or IEC errors without BIP errors, gives rise to a non-zero result when the TCTE calculates B3-IEC. These errors are counted as TC errors (that is errors occurring on the TCM link) which in turn are reported on TC-REI.

- “Saving Graphics Results to Instrument Store” page 244
- “Recalling Stored Graph Results” page 245
- “Viewing the Bar Graph Display” page 247
- “Viewing the Graphics Error and Alarm Summaries” page 249
- “Logging Graph Displays” page 251
- “Logging Results” page 253
- “Logging on Demand” page 261
- “Logging Jitter Tolerance Results” page 264
- “Logging Jitter Transfer Results” page 266
- “Logging Results to Parallel (Centronics) Printer” page 267
- “Logging Results to GP-IB Printer” page 268
- “Logging Results to Internal Printer” page 269
- “Logging Results to RS-232-C Printer” page 270
- “Printing Results from Disk” page 271
- “Connecting a Printer to a Parallel Port” page 272
- “Changing Internal Printer Paper” page 273
- “Cleaning Internal Printer Print Head” page 276

Storing, Logging and Printing

Saving Graphics Results to Instrument Store

Description

Graphical representation of measurement results is very useful particularly during a long measurement period. It provides an overview of the results and can be printed for record keeping.

Graphics results can be stored in instrument graph storage or on floppy disk.

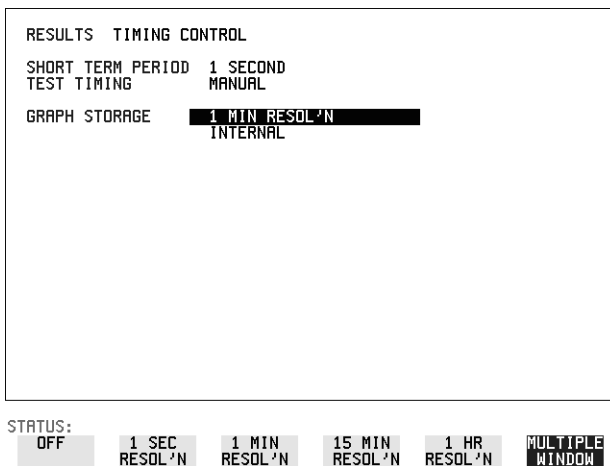

HOW TO:

- 1 Before starting your measurement, choose the GRAPH STORAGE resolution and location.
The resolution chosen affects the ZOOM capability when viewing the bar graphs. If 1 MIN is selected, 1 MIN/BAR, 15 MINS/BAR and 60 MINS/BAR are available. If 15 MINS is selected, 15 MINS/BAR and 60 MINS/BAR are available. If 1 HOUR is selected, 60 MINS/BAR is available.
The graphics results can be stored in the instrument - INTERNAL or stored on DISK. Storage to disk will use a default file name unless a file name is specified on the **OTHER FLOPPY DISK** display. See "Saving Graphical Results to Disk" page 290.
- 2 Press **RUN/STOP** to start the measurement. Graphical results will be stored in the chosen location.

Recalling Stored Graph Results

Description

Results stored from a previous measurement can be recalled to the graphics displays for viewing and printing.

STORE	START	START	TEST	STORE
	DATE	TIME	DURATION	USE
DISK				
-9				
-8				
-7				
-6				
-5				
-4				
-3				
-2	10-JUL-1997	15:20	16h 28m 34s	2%
-1	11-JUL-1997	07:50	00h 01m 04s	<1%
LAST	12-JUL-1997	07:51	00h 01m 19s	N11
STORAGE 1 SEC			TOTAL USED	2%
RESOL'N COMPRESSED			RAM FREE	98%
FREE STORE 19626 EVENTS				

STATUS:
GRAPH RESULTS **TEXT RESULTS** **DELETE STORE** **DELETE ALL** **MULTIPLE WINDOW**



HOW TO:

- 1 Press **GRAPH** to view the bar graph display.
- 2 If currently viewing the bar graph display, select **TEXT RESULTS** then **STORE STATUS**. If currently viewing the error or alarm summary, select **STORE STATUS**.
- 3 Using **↑** and **↓**, move the highlighted cursor to the store location which contains the required results.
If the required results are stored on Disk, move the highlighted cursor to DISK and choose RECALL GRAPHICS on the FLOPPY DISK display. See "Recalling Graphics Results from Disk" page 297.
- 4 Choose **GRAPH RESULTS** if you wish to view the bar graphs.
The display will change to the bar graph display of the highlighted results.
- 5 Choose **TEXT RESULTS** if you wish to view the error and alarm Summaries.
The display will change to the text results display of the highlighted results.
DELETE STORE deletes the results in the highlighted store.
If **DELETE ALL** is chosen, a **CONFIRM DELETE**; **ABORT DELETE** choice prevents accidental deletion of all the stored results.

Storing, Logging and Printing

Recalling Stored Graph Results

The top row of the display comprises five fields:

Store	Memory location in which the displayed bar graph data is stored. Move the highlighted cursor, to the STORE location desired, using  and  .
Start Date	The start date of the test, which produced the stored results.
Start Time	The start time of the test, which produced the stored results.
Test Duration	The duration of the test, which produced the stored results.
Store Use	The percentage (%) of the overall storage capacity occupied by each set of stored results. The TOTAL percentage used and the percentage still FREE is provided at the bottom of the STORE USE column.

Viewing the Bar Graph Display

Description

All the graphic results obtained during the measurement are available for viewing. Identify a period of interest and zoom in for more detailed examination.

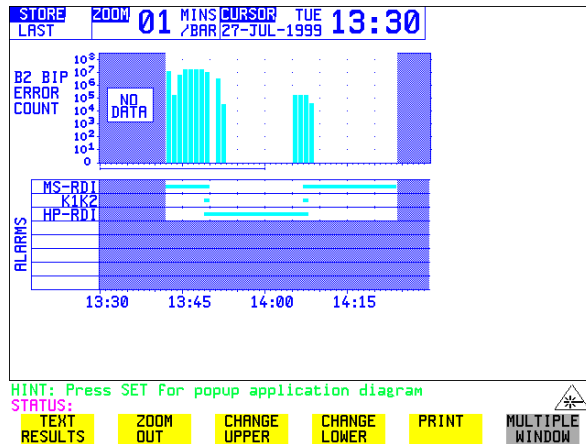

HOW TO:



- 1 To view the current bar graphs, press **GRAPH** and use **CHANGE UPPER** and **CHANGE LOWER** to obtain the bar graphs required.
- 2 To view previously stored graphs, see "Recalling Stored Graph Results " page 245.
- 3 For more detailed inspection of the bar graph, position the cursor centrally within the area of interest using **→**, **←** and select **ZOOM IN** to reduce the time axis to 15 MINS/BAR. This is only possible if the graphics results were stored with a STORAGE resolution of 1 SEC,1 MINS or 15 MINS.
For further reduction of the time axis to 01 MINS/BAR or 01 SECS/BAR, position the cursor centrally within the area of interest and select **ZOOM IN** until the required time axis is obtained.

The top row of the display comprises three fields:

- Store** Memory location in which the displayed bar graph data is stored. Store can only be changed when the status of stored results is displayed. See "Recalling Stored Graph Results " page 245.
- Zoom** The width, in minutes, of each "bar" in the bar graph, controlled by **ZOOM IN** / **ZOOM OUT** .

Storing, Logging and Printing
Viewing the Bar Graph Display

Cursor

The cursor position in terms of time and date, controlled by  and . The cursor position changes in steps of 1 second, 1 minute, 15 minutes or 60 minutes dependent upon the ZOOM setting. The cursor is physically located between the two graphs.

Viewing the Graphics Error and Alarm Summaries

Description

The error and alarm summaries of the measurement chosen are displayed on the **TEXT RESULTS** display. The error summary or alarm summary can be viewed at any time.

STORE	START	14:28	STOP	14:48
-1	TUE 8-SEP-1998		TUE 8-SEP-1998	
DSn ERROR SUMMARY				
	COUNT		RATIO	
BIT	261865		1.423E-04	
BPU	202187		3.715E-06	
DS3 FRAME	838		2.369E-06	
DS1 FRAME	12		1.877E-06	
P-BIT	224151		4.197E-06	
C-BIT	50271		9.424E-07	
FEBE	16981		3.202E-07	
CRC	N/A		N/A	

STATUS:

STORE STATUS	GRAPH RESULTS	PRINT	NEXT SUMMARY	ALARM SUMMARY	MULTIPLE WINDOW
--------------	---------------	-------	--------------	---------------	-----------------

HOW TO:

- 1 To view the error or alarm summary associated with the current bar graphs, press **GRAPH** then **TEXT RESULTS**.
- 2 To view the error or alarm summary associated with previously stored bar graphs, see "Recalling Stored Graph Results " page 245.
- 3 To view the Alarms which have occurred during the measurement, select **ALARM SUMMARY**. Use **NEXT SUMMARY** to view the PDH/DSn; and SDH Alarm Summaries in turn if applicable.
- 4 To view the Errors which have occurred during the measurement select **ERROR SUMMARY**. Use **NEXT SUMMARY** to view the PDH/DSn; and SDH Error Summaries in turn if applicable.

The top row of the display comprises three fields:

Store Memory location in which the bar graphs, error summary and alarm summary are stored.
Store can only be changed when the status of stored results is displayed. See "Recalling Stored Graph Results " page 245.

Viewing the Graphics Error and Alarm Summaries

Start	The start time and date of the test, that produced the displayed results.
Stop	The stop time and date of the test, that produced the displayed results.

Logging Graph Displays

Description

The bar graphs and error and alarm summaries can be logged to the disk for printing at a later date or logged to an internal printer if Option 602 is fitted.

If Option 601, Remote Control, is fitted, the bar graphs and error and alarm summary can be logged to an external Printer at the end of the test period. If a Printer is not immediately available, the graphics results remain in memory and can be logged at a later time when a Printer becomes available. Suitable HP Printers are the HP 660, HP 690C, HP 500 or HP 400.

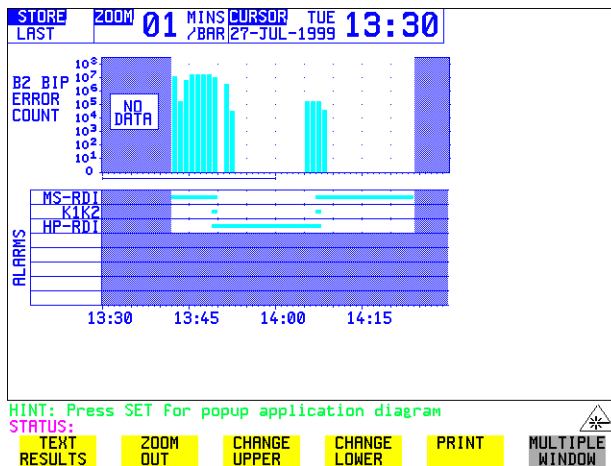

HOW TO:

Log to a Printer

- 1 Choose the logging DEVICE.

The logging device can be selected on the **OTHER LOGGING** display when SETUP is set to **LOGGING DEVICE**. For more details on the choice of devices and how to setup the instrument to interface with them please refer to the following sections:

- RS232: “Logging Results to RS-232-C Printer” page 270.
- GPIB: “Logging Results to GP-IB Printer” page 268
- PARALLEL: “Logging Results to Parallel (Centronics) Printer” page 267.
- INTERNAL (only if Option 602, Internal Printer, is fitted): “Logging Results to Internal Printer” page 269.

Storing, Logging and Printing

Logging Graph Displays

- 2 Press **GRAPH** to view the bar graph display. To log the Error and Alarm summaries, the displayed Bar graphs and the Alarm graph to the printer, choose **PRINT** on the bar graph display.
- 3 Choose to confirm or abort the print.
To confirm the print and only print the portion of the graph displayed and the summaries choose **THIS SCREEN**.
To confirm the print and print the graph for the whole measurement period and the summaries choose **CURSOR TO END**.
To abort the print choose **ABORT**.
- 4 To log the selected Error and Alarm summaries to the printer, choose **PRINT** on the Text Results display.

HOW TO:

Log to the Internal Disk Drive

- 1 Insert a floppy disk in the disk drive.
- 2 Choose LOGGING PORT **DISK** on the **OTHER LOGGING** display.
Enter a filename on the **OTHER FLOPPY DISK** display. See "Saving Data Logging to Disk " page 294.
- 3 Press **GRAPH** to view the bar graph display. To log the Error and Alarm summaries, the displayed Bar graphs and the Alarm graph to the disk, choose **PRINT** on the bar graph display.
- 4 Choose to confirm or abort the print.
To confirm the print and only print the portion of the graph displayed and the summaries choose **THIS SCREEN**.
To confirm the print and print the graph for the whole measurement period and the summaries choose **CURSOR TO END**.
To abort the print choose **ABORT**.
- 5 To log the selected Error and Alarm summaries to the disk, choose **PRINT** on the Text Results display.

Logging Results

Description

Test Period Logging

If degradations in system performance can be observed at an early stage, then the appropriate remedial action can be taken to maximize circuit availability and avoid system crashes.

Test period logging allows you to monitor the error performance of your circuit over a user defined test period. If required, results can be logged at regular intervals during this test period but, regardless of whether or not Periodic Logging is selected, the results will be logged at the end of the test period. An instant summary of the results can also be demanded by pressing **PRINT NOW**. This will not affect any test period in progress.

The user can choose to log all available results or else a subset of the available results (eg Errors, Jitter, G.826, M.2100 etc). This means the logging output can be tailored to contain only the results that are of particular interest.

Error Event Logging

Manual tracing of intermittent faults is time consuming. Error event logging allows you to carry out unattended long term monitoring of the circuit. Each occurrence of an error event is logged.

Any Alarm occurrence results in a timed and dated message being logged.

Logging Output

The results can be logged to the following devices:

- Optional Internal printer fitted into the instrument front cover (Option 602)
- External GP-IB printer (option 601)
- External RS-232-C printer (option 601)
- External Parallel Port printer (option 601)
- Internal Disk Drive

HOW TO:

Selecting Logging Device

The logging device can be selected on the **OTHER LOGGING** display when SETUP is set to **LOGGING DEVICE**. For more details on the choice of devices

Storing, Logging and Printing

Logging Results

and how to setup the instrument to interface with them please refer to the following sections:

- RS232: “Logging Results to RS-232-C Printer” page 270.
- GPIB: “Logging Results to GP-IB Printer” page 268
- PARALLEL: “Logging Results to Parallel (Centronics) Printer” page 267.
- DISK: “Saving Data Logging to Disk” page 294.
- INTERNAL (only if Option 602, Internal Printer, is fitted): “Logging Results to Internal Printer” page 269.

Enabling Test Period Logging

To enable Test Period Logging first select the **OTHER LOGGING** display and then set TEST PERIOD LOGGING to be **ON**. For more information on setting up the actual Test Period (ie Gating Period) please refer to the “Test Timing” page 111 Section.

FUNCTION	LOGGING
TEST PERIOD LOGGING	ON
SETUP	CONTENT
LOG ERROR RESULTS	ON
LOG JITTER RESULTS	ON
LOG G.821 RESULTS	ON
LOG G.826 RESULTS	ON
LOG M.2100 RESULTS	ON
LOG M.2101 RESULTS	ON
LOG M.2110 RESULTS	ON
LOG M.2120 RESULTS	ON
LOG ERROR SECONDS	OFF

STATUS: LOGGING DEVICE LOGGING CONTENT LOGGING PERIOD LOG ON DEMAND MULTIPLE WINDOW

Selecting Logging Content

The SETUP **LOGGING CONTENT** selection on the **OTHER LOGGING** display allows the user to choose which type of results they wish to log. For example if they only wished to log the G.821 and G.826 Analysis Results then they would simply set LOG G.821 RESULTS and LOG G.826 RESULTS to be **ON** while setting all the other selections to be **OFF**. There is no restriction as to what

Storing, Logging and Printing

Logging Results

result selection is made but please note that the selections all default to be **ON** so that all results are logged by default.

When TEST PERIOD LOGGING is set to **ON** then there is a LOG ERROR SECONDS selection on the SETUP **LOGGING CONTENT** display. Setting LOG ERROR SECONDS to be **ON** means that, if errors are detected during the Test Period, then a timed and dated message is logged each time an error second occurs. The message will contain the type of error detected and the number of errors of that type which were received in the error second. Note that if there are excessive occurrences of error seconds during a Test Period then having this selection switched **ON** will result in heavy use of printer paper.

Selecting Logging Period

FUNCTION	LOGGING
TEST PERIOD LOGGING SETUP	ON PERIOD
LOGGING PERIOD	OFF

STATUS: OFF 10 MINS 1 HOUR 24 HOURS USER PROGRAM MULTIPLE WINDOW

As well as logging results at the end of the Test Period, the user can also select a logging period. The logging period is setup via SETUP **LOGGING PERIOD** on the **OTHER LOGGING** display. At the end of each of these logging periods results will be logged. Note that this selection is only offered when TEST PERIOD LOGGING is set to **ON**.

The length of the logging period is setup using the LOGGING PERIOD selection. This offers a number of preset intervals along with a USER PROGRAM choice which provides a choice of 10 minutes to 99 hours. The actual logging period chosen by the user should be of a shorter duration than the test period in order that results can be logged periodically within the test period.

Storing, Logging and Printing

Logging Results

When a logging period is selected, then the user can choose whether **ALL** results are to be logged at the end of each period or a **SELECTED** subset. Note that this selection is in addition to that already made on the SETUP **LOGGING CONTENT** page.

The WHEN selection allows the user to have results logged **ALWAYS** at the end of each logging period or only when the error count for the logging period is greater than 0 ie **PERIOD EC>0** . If the error count is 0 then the message NO BIT ERRORS is displayed.

The TYPE selection allows the user to choose whether the results logged at the end of each period are the Cumulative Results, Period Results or both. The definitions for these two result types are as follows:

Period Results: The Results obtained over a set period of time during the test ie the logging period.

Cumulative Results: The results obtained over the elapsed time since the start of the test period.

Logging Results Examples

There are four phases of results logging:

- Start of measurement - Header is logged
- During the measurement - Alarm events and if enabled error events
- End of logging period - Complete set of period and cumulative results
- End of measurement - Complete set of cumulative results.

Logging Header

When the measurement is started the logging header provides a record of the instrument configuration that produced the results.

```
-----  
|                               OmniBER 37718                               |  
|                               Instrument Configuration                       |  
|-----  
| Receive Signal   : STM-16 OPTICAL      STM-1 under test   : 1  
| Mapping         : AU-4      TU-12     ASYNC 2Mb/s  
| Selected TU     : TUG3[1] TUG2[1] TU[1]  
| TCM Path       : OFF  
| Payload (Struct) : PCM30CRC  
| Test Signal    : 64kb/s  
| Tributaries    :                               64kb [ 1 ]  
| Pattern        : 2^11-1      Polarity      : NORMAL  
| MEASUREMENT STARTED 14 Jul 00 12:39:49      Print Period OFF  
|-----
```

Storing, Logging and Printing

Logging Results

Logging During Measurement

During the measurement a timed and dated message is logged each time an alarm occurs, and if LOG ERROR SECONDS [ON] is chosen a timed and dated message is logged each time an error second occurs (excessive occurrences of error seconds during the logging period will result in heavy use of printer paper).

```
| 12:41:38 B1 BIP          32252      |
| 12:41:38 B2 BIP          673688     |
| 12:41:38 B3 BIP          17419     |
| 12:41:38 HP-REI           77         |
| 12:41:38 TU BIP           820         |
| 12:41:38 LP-REI           2          |
| 12:41:38 ALA2 FRAME      3445         |
| 12:41:38 MS-REI          1095         |
| 12:41:38 BIT              36         |
| 12:41:38 FAS 2M           16         |
| 12:41:38 CRC              490         |
| 12:41:57 LOF              SET        |
| 12:41:57 OOF              SET        |
| 12:41:57 AU-LOP           SET        |
| 12:41:57 H4 LOM           SET        |
| 12:41:57 TU-LOP           SET        |
| 12:41:57 Loss of Frame 2M SET        |
| 12:41:57 MultiFrame Loss  SET        |
| 12:41:57 Pattern Loss     SET        |
| 12:42:06 LOF              CLEAR      |
| 12:42:06 OOF              CLEAR      |
| 12:42:06 AU-LOP           CLEAR      |
| 12:42:06 H4 LOM           CLEAR      |
| 12:42:06 TU-LOP           CLEAR      |
| 12:42:06 Loss of Frame 2M CLEAR      |
| 12:42:06 Pattern Loss     CLEAR      |
| 12:42:06 MultiFrame Loss  CLEAR      |
| 12:42:07                  ALL ALARMS CLEAR
```

Logging at the End of Measurement

At the end of the measurement a complete set of cumulative results are logged. At the end of each LOGGING PERIOD a complete set of Period results and a full set of cumulative results are logged.

Storing, Logging and Printing

Logging Results

```

=====
| MEASUREMENT COMPLETE 14 Jul 00 12:44:41 Elapsed Time 00d 00h 03m 34s |
=====
|
| Cumulative Results
|
| Error Results :
|
| AIA2 FRAME      B1 BIP      B2 BIP      MS-REI      B3 BIP
| Error Count      16908      320131     3.305E+06    5769      85340
| Error Ratio      1.053E-02    6.410E-07    6.691E-06    1.168E-08  2.828E-06
|
| HP-REI         TC-IEC         TC-ERR         OEI         TC-REI
| Error Count           361           N/A           N/A           N/A           N/A
| Error Ratio          1.196E-08          N/A           N/A           N/A           N/A
|
| TU BIP         LP-REI
| Error Count           4040           7
| Error Ratio          8.986E-06          1.557E-08
|
|
| FAS 140M      FAS 34M      FAS 8M      FAS 2M
| Error Count           N/A           N/A           N/A           79
| Error Ratio           N/A           N/A           N/A          1.406E-05
|
| BIT          CODE          CRC          REBE
| Error Count           187           N/A          2411           1
| Error Ratio          1.456E-05          N/A          1.201E-02     4.983E-06
|
| Analysis Results :
|
| G.826 ANALYSIS
|
| B1 BIP      B2 BIP      MS-REI      B3 BIP
| Errored Blocks      74564      22502      186      22398
| Errored Seconds      18          10          4          10
| Severely Errored Seconds      16          9          0          9
| Unavailable Seconds      10          10          0          10
| Path Unavailable Seconds      N/A          10          10          10
| Background Block Errors      3017      1914      186      1898
| Errored Second Ratio      8.824E-02    4.902E-02    2.020E-02    4.902E-02
| Severely Errored Sec Ratio      7.843E-02    4.412E-02    0          4.412E-02
| Background Block Err Ratio      2.006E-03    1.227E-03    1.174E-04    1.217E-03
|
| HP-REI      TC-IEC      TC-ERR      OEI
| Errored Blocks      98          N/A          N/A          N/A
| Errored Seconds      4          N/A          N/A          N/A
| Severely Errored Seconds      0          N/A          N/A          N/A
| Unavailable Seconds      0          N/A          N/A          N/A
| Path Unavailable Seconds      10          N/A          N/A          N/A
| Background Block Errors      98          N/A          N/A          N/A
| Errored Second Ratio      2.020E-02    N/A          N/A          N/A
| Severely Errored Sec Ratio      0          N/A          N/A          N/A
| Background Block Err Ratio      6.187E-05    N/A          N/A          N/A

```

Storing, Logging and Printing Logging Results

	TC-REI	TU-BIP	LP-REI		
Errored Blocks	N/A	3341	7		
Errored Seconds	N/A	10	2		
Severely Errored Seconds	N/A	9	0		
Unavailable Seconds	N/A	10	0		
Path Unavailable Seconds	N/A	10	10		
Background Block Errors	N/A	282	7		
Errored Second Ratio	N/A	4.902E-02	1.010E-02		
Severely Errored Sec Ratio	N/A	4.412E-02	0		
Background Block Err Ratio	N/A	7.231E-04	1.768E-05		
M.2101 ANALYSIS					
	Section		High Order Path		
	Rx	Tx	Rx	Tx	
Errored Seconds	10	4	10	4	
Severely Errored Seconds	10	0	10	0	
Unavailable Seconds	10	0	10	0	
	Low Order Path				
	Rx	Tx			
Errored Seconds	10	2			
Severely Errored Seconds	9	0			
Unavailable Seconds	10	0			
G.821 ANALYSIS					
	BIT	FAS 140M	FAS 34M	FAS 8M	FAS 2M
Errored Sec	10	N/A	N/A	N/A	10
%Errored Sec	4.90196	N/A	N/A	N/A	4.90196
%ES (Annex D)	1.96078	N/A	N/A	N/A	N/A
Error Free Sec	194	N/A	N/A	N/A	194
%Error Free Sec	95.09804	N/A	N/A	N/A	95.09804
Severely Err Sec	8	N/A	N/A	N/A	7
%Severely Err Sec	3.92157	N/A	N/A	N/A	3.43137
Degraded Minutes	1	N/A	N/A	N/A	1
%Degraded Minutes	25.00000	N/A	N/A	N/A	25.00000
Unavailable Sec	10	N/A	N/A	N/A	10
%Unavailable Sec	4.67290	N/A	N/A	N/A	4.67290
			CODE	CRC4	REBE
Errored Sec			N/A	10	4
%Errored Sec			N/A	4.90196	2.02020
Error Free Sec			N/A	194	194
%Error Free Sec			N/A	95.09804	97.97980
Severely Err Sec			N/A	8	4
%Severely Err Sec			N/A	3.92157	2.02020
Degraded Minutes			N/A	1	0
%Degraded Minutes			N/A	25.00000	0.00000
Unavailable Sec			N/A	10	0
%Unavailable Sec			N/A	4.67290	0.00000

Storing, Logging and Printing Logging Results

G.826 ANALYSIS						
	Near	8Mb/s	Far	Near	2Mb/s	Far
Errored Blocks	N/A		N/A	2411		1
Errored Seconds	N/A		N/A	10		4
Severely Errored Seconds	N/A		N/A	8		4
Unavailable Seconds	N/A		N/A	10		0
Path Unavailable Seconds	N/A		N/A	10		10
Background Block Errors	N/A		N/A	694		0
Errored Second Ratio	N/A		N/A	4.902E-02	2.020E-02	
Severely Errored Sec Ratio	N/A		N/A	3.922E-02	2.020E-02	
Background Block Err Ratio	N/A		N/A	3.541E-03		0
BIT Errors						
Errored Blocks		187				
Errored Seconds		10				
Severely Errored Seconds		6				
Unavailable Seconds		10				
Background Block Errors		187				
Errored Second Ratio		4.902E-02				
Severely Errored Sec Ratio		2.941E-02				
Background Block Err Ratio		1.181E-04				
M.2100 ANALYSIS						
	Rx	8Mb/s	Tx	Rx	2Mb/s	Tx
Errored Seconds	N/A		N/A	10		4
Severely Errored Seconds	N/A		N/A	7		4
Unavailable Seconds	N/A		N/A	10		0
64k Rx						
Errored Seconds		10				
Severely Errored Seconds		8				
Unavailable Seconds		10				
M.2110 ANALYSIS						
	15-min	1-hr	2-hr	24-hr	7-day	
BIS Results	WAIT	WAIT	WAIT	WAIT	WAIT	
Frequency : 2488320.0 kHz Offset : +0.0 kHz Offset : +0.0ppm						
Power Level : -13.0 dBm STM-16o OPTICAL						
Pointer Results :						
	AU POINTER			TU POINTER		
	Count	Seconds		Count	Seconds	
NDF			0			0
Missing NDF			0			0
+ve Pointer Adjustments	0	0		0	0	
-ve Pointer Adjustments	0	0		0	0	
Implied VC Offset		0.0			0.0	
Pointer Value		0			0	

Logging on Demand

Description

When **PRINT NOW** is pressed the chosen results are logged to the chosen logging device. The choice of results for logging is:

- RESULTS SNAPSHOT - last recorded measurement results
- OVERHEAD SNAPSHOT - last recorded overhead values of the chosen STM-N
- OVERHEAD CAPTURE - Overhead Capture display
- POINTER GRAPH - Pointer Graph display
- SDH TRIBUTARY SCAN - SDH Tributary Scan display
- SDH ALARM SCAN - SDH Alarm Scan display
- SCREEN DUMP - allows logging of the chosen display

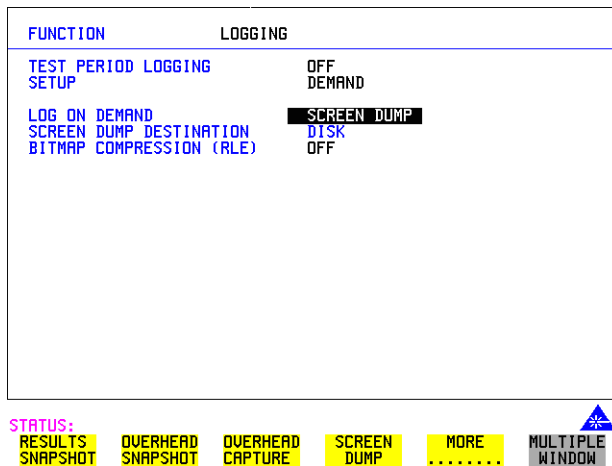

HOW TO:

- 1 Choose LOG ON DEMAND to determine results to be logged when **PRINT NOW** is pressed.
SCREEN DUMP allows you to log the selected display when **PRINT NOW** is pressed. (Logging or Disk displays cannot be logged using this feature).
- 2 Choose the logging DEVICE.
The logging device can be selected on the **OTHER LOGGING** display when SETUP is set to **LOGGING DEVICE**. For more details on the choice of devices and how to setup the instrument to interface with them please refer to the following sections:
 - RS232: “Logging Results to RS-232-C Printer” page 270.

Storing, Logging and Printing

Logging on Demand

- GPIB: “Logging Results to GP-IB Printer” page 268.
- PARALLEL: “Logging Results to Parallel (Centronics) Printer” page 267.
- DISK: “Saving Data Logging to Disk” page 294. If SCREEN DUMP is chosen then please refer to “Saving a Screen Dump to Disk” page 292.
- INTERNAL (only if Option 602, Internal Printer, is fitted): “Logging Results to Internal Printer” page 269.

Log on Demand Examples

Overhead Capture, Pointer Graph, SDH Tributary Scan and SDH Alarm Scan logging are copies of the relevant display. Screen Dump logs a copy of the selected display (not Logging or Disk displays).

Overhead Snapshot

Overhead Snapshot provides the value of each byte of overhead in the STM-1 chosen for test.

```

=====
| 12:46:00 PRINT DEMANDED- O/H SNAPSHOT           Elapsed Time  00d 00h 03m 34s|
=====
|           | Setup : STM-16 OPTICAL                |
-----
|           | SOH (STM-1 #1 )                                |
-----+-----+-----+-----+-----+-----+-----+
| A1 | F6  F6  F6  | A2 | 28  28  28  | J0 | 01  AA  AA  | J0 Path Trace: |
| B1 | A2  00  00  | E1 | 00  00  00  | F1 | 00  00  00  | "              |
| D1 | 00  00  00  | D2 | 00  00  00  | D3 | 00  00  00  | E.164 CRC NOT FOUND |
| H1 | 68  93  93  | H2 | 00  FF  FF  | H3 | 00  00  00  | S1 Sync Status: |
| B2 | 00  E0  3E  | K1 | 00  00  00  | K2 | 00  00  00  | QUALITY UNKNOWN  |
| D4 | 00  00  00  | D5 | 00  00  00  | D6 | 00  00  00  |                 |
| D7 | 00  00  00  | D8 | 00  00  00  | D9 | 00  00  00  |                 |
| D10| 00  00  00  | D11| 00  00  00  | D12| 00  00  00  |                 |
| S1 | 00  00  00  | Z2 | 00  00  00  | E2 | 00  00  00  |                 |
-----+-----+-----+-----+-----+-----+
| High Order POH      TYPE VC-4 | Low Order POH      TYPE VC-12 |
| WITHIN STM-1 #1     |                               |
-----+-----+-----+-----+-----+
|           | HP Path Label (C2):                | LP Path Label (V5):                | | |
| J1 | 00  "TUG STRUCTURE          | V5 | 04  "010 ASYNCHRONOUS          |
| B3 | 07  "                        | J2 | 00  "                        |
| C2 | 02  J1 Path Trace:          | N2 | 00  J2 Path Trace:          |
| G1 | 00  "~~~~~"                | K4 | 00  "~~~~~"                |
| F2 | 00  "                        |   |   |                               |
| H4 | 25  "                        |   |   |                               |
| F3 | 00  "                        |   |   |                               |
| K3 | 00  "                        |   |   |                               |
| N1 | 00  "                        |   |   |                               |

```

Storing, Logging and Printing Logging on Demand

Results Snapshot

Results Snapshot provides a Header listing the instrument settings that produced the results and the last recorded, complete set of cumulative measurement results.

```

=====
12:48:02 PRINT DEMANDED- RESULTS SNAPSHOT Elapsed Time 00d 00h 03m 34s
=====
                          Cumulative Results
=====
Error Results :
      A1A2 FRAME      B1 BIP      B2 BIP      MS-REI      B3 BIP
Error Count      16908      320131      3.305E+06      5769      85340
Error Ratio      1.053E-02      6.410E-07      6.691E-06      1.168E-08      2.828E-06

      HP-REI      TC-IEC      TC-ERR      OEI      TC-REI
Error Count      361      N/A      N/A      N/A      N/A
Error Ratio      1.196E-08      N/A      N/A      N/A      N/A

      TU BIP      LP-REI
Error Count      4040      7
Error Ratio      8.986E-06      1.557E-08

      FAS 140M      FAS 34M      FAS 8M      FAS 2M
Error Count      N/A      N/A      N/A      79
Error Ratio      N/A      N/A      N/A      1.406E-05

      BIT      CODE      CRC      REBE
Error Count      187      N/A      2411      1
Error Ratio      1.456E-05      N/A      1.201E-02      4.983E-06

Frequency : 2488320.0 kHz      Offset : +0.0 kHz      Offset : +0.0ppm
Power Level : -12.9 dBm      STM-16o OPTICAL

Pointer Results :
      AU POINTER      TU POINTER
      Count      Seconds      Count      Seconds
NDF      0      0      0      0
Missing NDF      0      0      0      0
+ve Pointer Adjustments      0      0      0      0
-ve Pointer Adjustments      0      0      0      0
Implied VC Offset      0.0      0.0
Pointer Value      0      0
=====

```

Logging Jitter Tolerance Results

Description

The jitter auto tolerance feature provides jitter tolerance measurements within the relevant ITU-T mask, G.823 for PDH, G.958 and G.825 for SDH.

You can log the jitter auto tolerance results to a printer for record keeping purposes. The **GRAPH** version and the **TEXT** version of the jitter tolerance results can be logged to a printer

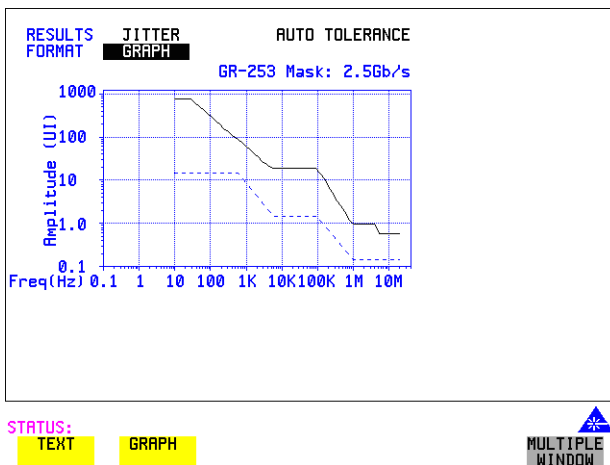

HOW TO:

- 1 Choose the logging DEVICE.
The logging device can be selected on the **OTHER LOGGING** display when SETUP is set to **LOGGING DEVICE**. For more details on the choice of devices and how to setup the instrument to interface with them please refer to the following sections:
 - RS232: “Logging Results to RS-232-C Printer” page 270.
 - GPIB: “Logging Results to GP-IB Printer” page 268
 - PARALLEL: “Logging Results to Parallel (Centronics) Printer” page 267.
 - INTERNAL (only if Option 602, Internal Printer, is fitted): “Logging Results to Internal Printer” page 269.

Storing, Logging and Printing

Logging Jitter Tolerance Results

- 2 Choose **GRAPH** on the **RESULTS** **AUTO TOLER** display or choose **TEXT** on the **RESULTS** **AUTO TOLER** display, if you wish to log the graph and text results to the printer.
- 3 Press **PRINT NOW** to log the chosen results to the printer.

Logging Jitter Transfer Results

Description

The jitter transfer feature provides jitter transfer measurements within the relevant ITU-T mask, G.823 for PDH and G.958 for SDH.

You can log the jitter transfer results to a printer for record keeping purposes. The **GRAPH** version or the **TEXT** version of the jitter transfer results can be logged to a printer.

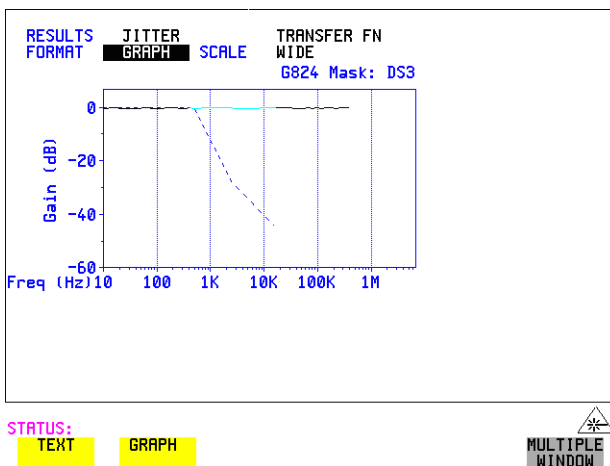

HOW TO:

- 1 Choose the logging **DEVICE**.
The logging device can be selected on the **OTHER LOGGING** display when **SETUP** is set to **LOGGING DEVICE**. For more details on the choice of devices and how to setup the instrument to interface with them please refer to the following sections:
 - RS232: "Logging Results to RS-232-C Printer" page 270.
 - GPIB: "Logging Results to GP-IB Printer" page 268
 - PARALLEL: "Logging Results to Parallel (Centronics) Printer" page 267.
 - INTERNAL (only if Option 602, Internal Printer, is fitted): "Logging Results to Internal Printer" page 269.
- 2 Choose **GRAPH** on the **RESULTS JITTER TN FUNCTION** display or choose **TEXT** on the **RESULTS JITTER TN FUNCTION** display if you wish to log the graph and text results to the printer.
- 3 Press **PRINT NOW** to log the chosen results to the printer.

Storing, Logging and Printing

Logging Results to Parallel (Centronics) Printer

Logging Results to Parallel (Centronics) Printer

Description

If Option 601, Remote Control Interface, is fitted, you can log the results and alarms to an external Parallel printer connected to the PARALLEL port. The Parallel port provides a standard IEEE 1284-A compatible interface.

FUNCTION	LOGGING
TEST PERIOD LOGGING SETUP	OFF DEVICE
LOGGING PORT	PARALLEL
REMOTE CONTROL PORT	GP1B
PRINTER TYPE	HP PRINTER

STATUS: **RS232** **GP1B** **DISK** **PARALLEL**  **MULTIPLE WINDOW**

CAUTION

Damage to the instrument may result if a serial connection is made to this port.

HOW TO:

- 1 Connect the Parallel printer to the PARALLEL port. See "Connecting a Printer to a Parallel Port " page 272.
- 2 If a non HP printer is connected then set PRINTER TYPE to be **ALT. PRINTER** . Set MODE to be **NORMAL** (80 character column width) or **COMPRESS** (40 character column width) according to the capabilities of your printer.
- 3 See "Logging Results " page 253 or "Logging on Demand " page 261 for more details on selecting the type of Results you wish to log.

Storing, Logging and Printing Logging Results to GP-IB Printer

Logging Results to GP-IB Printer

Description

If Option 601, Remote Control Interface, is fitted, you can log the results and alarms to an external GP-IB printer connected to the GP-IB port.

FUNCTION	LOGGING
TEST PERIOD LOGGING SETUP	OFF DEVICE
LOGGING PORT	GP-IB
REMOTE CONTROL PORT	RS232

STATUS: RS232 GP-IB DISK PARALLEL

MULTIPLE WINDOW 

HOW TO:

- 1 Connect an GP-IB printer to the GPIB port.

NOTE

Choosing GP-IB external printer for logging prevents the use of GP-IB remote control.

- 2 See "Logging Results " page 225 or "Logging on Demand " page 233 for more details on selecting the type of Results you wish to log.

Storing, Logging and Printing Logging Results to Internal Printer

Logging Results to Internal Printer

Description

If Option 602, Internal Printer is fitted, you can log the results and alarms to the in-
lid printer.

FUNCTION	LOGGING
TEST PERIOD LOGGING SETUP	ON DEVICE
LOGGING PORT REMOTE CONTROL PORT	INTERNAL GP1B

STATUS:

INTERNAL **RS232** **GP1B** **DISK** **PARALLEL** **MULTIPLE
WINDOW**

HOW TO:

- 1 See "Logging Results " page 225 or "Logging on Demand " page 233 for more details on selecting the type of Results you wish to log.

Storing, Logging and Printing

Logging Results to RS-232-C Printer

Logging Results to RS-232-C Printer

Description

If Option 601, Remote Control Interface, is fitted, you can log the results and alarms to an external RS-232-C printer connected to the RS-232-C port.

FUNCTION	LOGGING
TEST PERIOD LOGGING SETUP	OFF DEVICE
LOGGING PORT	RS232
REMOTE CONTROL PORT	LAN
PRINTER TYPE	HP PRINTER
SPEED	9600 BAUD
PROTOCOL	XON/XOFF

STATUS:

RS232

GP1B

DISK

PARALLEL

MULTIPLE
WINDOW

HOW TO:

- 1 Connect an RS-232-C printer to the RS-232-C port.

NOTE

Choosing RS232 external printer for logging prevents the use of RS-232-C remote control.

- 2 If a non HP printer is connected then set PRINTER TYPE to be **ALT. PRINTER**. Set MODE to be **NORMAL** (80 character column width) or **COMPRESS** (40 character column width) according to the capabilities of your printer.
- 3 Set SPEED to match the Baud Rate chosen on your printer.
- 4 Set PROTOCOL to match that required by your printer.
- 5 See "Logging Results " page 225 or "Logging on Demand " page 233 for more details on selecting the type of Results you wish to log.

Printing Results from Disk

Description

If you have inserted a disk into the internal disk drive and saved data to disk, you can print the contents of the disk using a PC and Printer as follows:

Remove the Disk from the OmniBER 718 and insert it into a personal computer (PC).

PC Instructions

HOW TO:

Print from DOS Prompt

copy/b a:\<filename> <printer name>

HOW TO:

Print from Windows

- 1** Choose the required file from Filemanager.
- 2** Choose FILE - COPY FILE TO
<printer name>

Connecting a Printer to a Parallel Port

Description

If Remote Control Option, 601, is fitted, the OmniBER 718 has the capability of interfacing with a Printer, via the PARALLEL port.

CAUTION

Do not connect a serial printer e.g. RS-232-C or GPIB to the HP 37718A Parallel port as this will damage the interface.

HOW TO:

- 1 Connect the OmniBER 718 Parallel port to your Printer Parallel port using printer cable HP 24542D.

Changing Internal Printer Paper

*Description Option
602 is required*

The printer accepts rolls of thermal paper with the following dimensions: :

Width: 216 mm (8.5 in) or 210 mm (8.27 in) (A4)
tolerance +2.0 mm - 1.0 mm

Maximum Outside Diameter: 40 mm

Inside Core Diameter: Between 12.5 mm and 13.2 mm

Suitable rolls of paper are available from Hewlett Packard, Part Number 9270-1360.

WARNING

The paper tear-off edge is **SHARP**. This edge is exposed when the printer cover is raised. Note the  **CAUTION SHARP EDGE** label on the cover.

HOW TO:

- 1 Raise the two locking tabs on the sides of the printer cover and then raise the cover.
- 2 Raise the printer mechanism front cover. This releases the paper drive. Remove any remaining paper from the front (in the normal direction of operation).

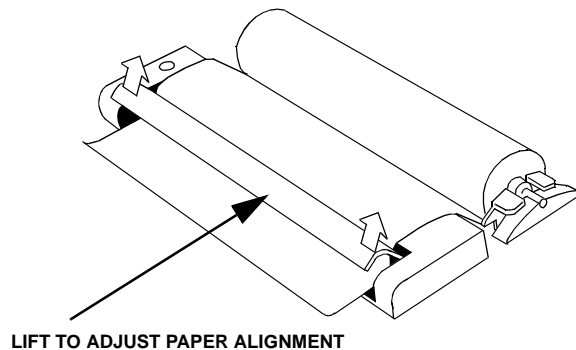

- 3 Lift out the spindle. Adjust the paper width adaptor to the width of the paper being used.

Storing, Logging and Printing

Changing Internal Printer Paper

- Put the paper roll on the spindle such that the sensitive side (slightly shiny) will be on the underside of the print mechanism. Ensure that the relocation of the spindle locks the blue width adaptor in position.

NOTE

The paper must be installed such that when it is in the print mechanism, the sensitive side (slightly shiny) is the underside.

The illustrations here show the correct fitting for HP 9270-1360 paper which has the sensitive side on the outside of the roll.

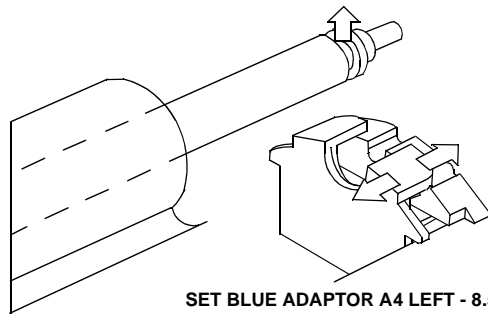

- Feed the paper into the upper entry of the print mechanism. When the front cover of the print mechanism is closed, the printer should automatically feed the paper through until there is approximately 2.5 cm (1 in) clear at the front of the print mechanism.

Align paper with the leftmost edge of the printer mechanism slot

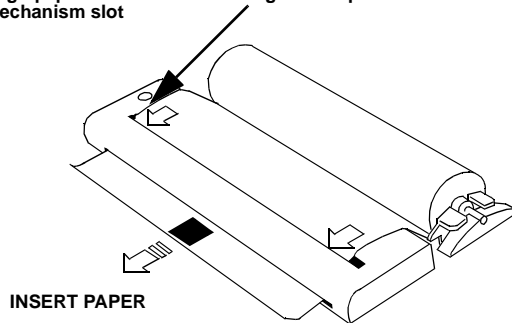

CAUTION

Do not close the outer cover until the automatic paper feed is complete.

Storing, Logging and Printing

Changing Internal Printer Paper

- 6 If the printer paper is incorrectly aligned, raise the printer mechanism front cover to releases the paper drive and realign the paper.

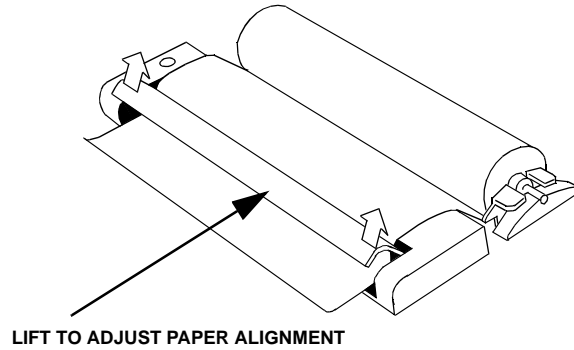

Cleaning Internal Printer Print Head

Description

The print head should be cleaned when broken or light characters occur in a vertical line on the page. To maintain a high quality print, clean the print head after 200 to 300 prints.

The print head is cleaned with a special cleaning paper which is supplied with the instrument.

WARNING

The paper tear-off edge is SHARP. This edge is exposed when the printer cover is raised. Note the  CAUTION SHARP EDGE label on the cover.

HOW TO:

- 1** Open the printer as for changing the paper see "Changing Internal Printer Paper" page 273.
If printer paper is fitted, remove it from the printer.
- 2** Feed the cleaning paper into the top entry of the print mechanism with the rough black side, which contains the cleaning material, towards the rear of the printer.
- 3** When the automatic feed is complete and the paper stops moving use the instrument front panel key **PAPER FEED** to move the cleaning paper through the print mechanism.
- 4** Remove the cleaning paper and replace the normal printer paper. See "Changing Internal Printer Paper " page 273.

NOTE

Retain the cleaning paper. It is designed to last for the life of the printer.

- “Storing Configurations in Instrument Store” page 278
- “Titling Configuration in Instrument Store” page 279
- “Recalling Configurations from Instrument Store” page 280
- “Formatting a Disk” page 281
- “Labeling a Disk” page 282
- “Managing Files and Directories on Disk” page 283
- “Accessing Directories and Files” page 284
- “Renaming a File on Disk” page 286
- “Deleting a File on Disk” page 287
- “Adding Descriptors to Disk Files” page 289
- “Deleting a Directory on Disk” page 288 “Deleting a File on Disk” page 287
- “Saving Graphical Results to Disk” page 290
- “Saving a Screen Dump to Disk” page 292
- “Saving Data Logging to Disk” page 294
- “Saving Configurations to Disk” page 295
- “Recalling Configuration from Disk” page 296
- “Recalling Graphics Results from Disk” page 297
- “Copying Configuration from Instrument Store to Disk” page 298
- “Copying Configuration from Disk to Instrument Store” page 300
- “Copying Graphics Results from Instrument Store to Disk” page 302

Using Instrument and Disk Storage

Storing Configurations in Instrument Store

Description

You can store measurement settings which are used regularly and recall them with a single operation.

One preset store is provided which cannot be overwritten, STORED SETTING NUMBER [0]. This store is used to set the instrument to a known state, the FACTORY DEFAULT SETTINGS.

FUNCTION		STORED SETTINGS	
STORED SETTING	NUMBER	1	
	LOCK	OFF	
	ACTION	OFF	
SETTING			
0	FACTORY DEFAULT SETTINGS		
1		
2		
3		
4		

STATUS: OFF RECALL SAVE MULTIPLE WINDOW

HOW TO:

- 1 Set the OmniBER 718 to the configuration you wish to store.
- 2 Choose the STORED SETTING NUMBER to receive the configuration.
- 3 Choose LOCK **OFF**.
- 4 Choose ACTION **SAVE** to store the configuration in the chosen store.
- 5 To add a descriptive title see "Titrating Configuration in Instrument Store" page 279.

Titling Configuration in Instrument Store

Description

When storing configurations, you can give them an easily remembered title for identification at a later date.

FUNCTION		STORED SETTINGS	
STORED SETTING	NUMBER		1
	LOCK		OFF
	ACTION		OFF
SETTING			
0	FACTORY DEFAULT SETTINGS		
1	PAYLOAD.MAPPING.....		
2	SDH.ANALYSIS.....		
3		
4		

STATUS:
JUMP **PREVIOUS CHAR** **NEXT CHAR** **←** **→** **MULTIPLE WINDOW**

HOW TO:

- 1 Choose the STORED SETTING NUMBER which contains the stored configuration.
- 2 Choose LOCK **OFF**.
- 3 Use **JUMP**; **NEXT CHAR**; **PREVIOUS CHAR**; **→** and **←** to title the settings.

Recalling Configurations from Instrument Store

Description

Having stored a configuration for future use, you must be able to recall that configuration in the future.

FUNCTION		STORED SETTINGS	
STORED SETTING NUMBER		2	
LOCK		OFF	
ACTION		OFF	
SETTING			
0	FACTORY DEFAULT SETTINGS		
1	PAYLOAD.MAPPING.....		
2	SDH.ANALYSIS.....		
3		
4		

STATUS:
OFF RECALL SAVE **MULTIPLE WINDOW**

HOW TO:

- 1 Choose the STORED SETTING NUMBER which contains the stored configuration.
- 2 Choose ACTION **RECALL** to recall the stored configuration.
The recall operation can be verified by checking the relevant display settings.

Formatting a Disk

Description

Only 1.44M, MS-DOS compatible disks can be used in the OmniBER 718. Any other format or capacity will result in a disk access error being displayed.

FUNCTION	FLOPPY DISK
DISK OPERATION	DISK FORMAT
Insert Disk Select OK to perform operation <input type="checkbox"/> OFF	
A:\ LABEL: no label	FREE: unknown Bytes

STATUS:
 OFF OK

MULTIPLE WINDOW

NOTE

Disks can be formatted in an IBM compatible PC but it is recommended that the disk is formatted in the OmniBER 718 as this will ensure full compatibility with the Floppy Disk power fail recovery included in the OmniBER 718.

HOW TO:

- 1 Choose DISK OPERATION **DISK FORMAT**.
- 2 Insert the Disk into the Disk drive.
- 3 Choose **OK** to Format the disk.

A warning that this operation will erase all data is displayed and asks "do you wish to continue".

If YES is selected, all the data on the Disk will be erased and the disk will be formatted.

If NO is selected, the operation is aborted. This allows you to view the data on the Disk and verify that it is no longer needed.

Labeling a Disk

Labeling a Disk*Description*

You can label your disks for ease of identification.

FUNCTION	FLOPPY DISK
DISK OPERATION LABEL	DISK LABEL MY DISK
Select OK to perform operation	<input type="checkbox"/> OFF
A:\ LABEL: MY DISK	FREE: Bytes

STATUS:

 OFF OKMULTIPLE
WINDOW*HOW TO:*

- 1 Choose DISK OPERATION **DISK LABEL**.
- 2 Label the Disk using **PREVIOUS CHAR** **NEXT CHAR** **→** **←** or press **SET** and use the pop-up keypad.
- 3 Choose **OK** to confirm the label is correct.
The label is displayed at the bottom of the display to confirm the operation has taken place.

Managing Files and Directories on Disk

Description

File and Directory structures can be important in speeding up the transfer of data between the instrument and the disk drive.

It is recommended that you create a directory structure as an aid to efficient file management particularly when the disk is moved to a PC.

Creating a Directory on Disk

FUNCTION	FLOPPY DISK
DISK OPERATION	FILE CREATE DIRECTORY
NAME	SDH
Select OK to perform operation	OFF
A:\ LABEL:	FREE: Bytes

STATUS:

OFF

OK

MULTIPLE
WINDOW

HOW TO:

- 1 Choose DISK OPERATION **FILE CREATE DIRECTORY** on the **OTHER FLOPPY DISK** display.
- 2 Enter the directory name using **PREVIOUS CHAR** **NEXT CHAR** **→** **←** or press **SET** and use the pop-up keypad.
The directory name can contain up to 8 alphanumeric characters.
- 3 To create the directory choose **OK**.
This will create a sub directory of the directory displayed at the bottom of the display. In this example A:\SDH will be created.

Using Instrument and Disk Storage

Managing Files and Directories on Disk

Accessing Directories and Files

- 1 Choose DISK OPERATION **SAVE**.
- 2 Choose FILE TYPE you wish to view.
This acts as a filter on the filename extension:
CONFIGURATION - .CNF filter, **GRAPHICS** - .SMG filter,
DATA LOGGING - .PRN filter, **SCREEN DUMP** - .BMP filter.
- 3 Move the highlighted cursor to the NAME field and press **SET**.

NOTE

- . <DIR> - Current Directory.
 - .. <DIR> - Parent directory. Move highlighted cursor to this line and press **SET** to move to parent directory.
- 4 Move the highlighted cursor to
.. <DIR> and press **SET** to move to parent directory.
 - 5 Move the highlighted cursor to the directory required and press **SET** to move to that directory. (The directory name will appear on the display).
Only the files with the file extension chosen in FILE TYPE will be displayed.

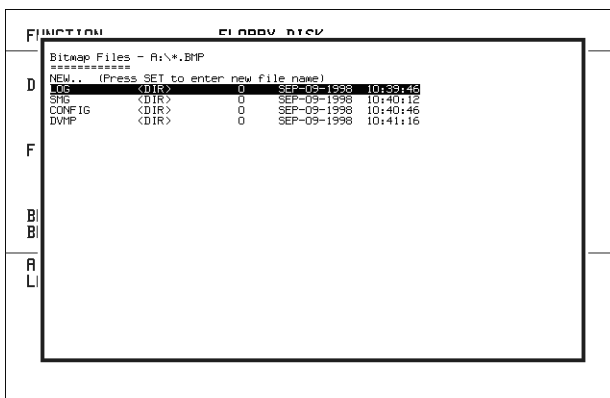

STATUS:

**MULTIPLE
WINDOW**

- 6 Move the highlighted cursor up and down the display using **↑** and **↓**.

Using Instrument and Disk Storage

Managing Files and Directories on Disk

NOTE

Title Bar - File types displayed and current directory. (cannot be highlighted).

. <**DIR**> - Current Directory.

.. <**DIR**> - Parent directory. Move highlighted cursor to this line and press **SET** to move to parent directory.

SDH1.PRN - File (with named extension) in current directory. Move highlighted cursor to this line and press **SET** to select the file. The display will return to the **SAVE** display and the selected file name will appear in the FILE NAME field.

NEXT - Move highlighted cursor to this line and press **SET** to access the next page of file names.

PREV - Move highlighted cursor to this line and press **SET** to access the previous page of file names.

FUNCTION		C floppy disk		
Data Logging Files - A:\LOG*.PRN				

NEW.. (Press SET to enter new file name)				
D	.	<DIR>	0	SEP-09-1998 10:39:46
	.	<DIR>	0	SEP-09-1998 10:39:46
	SDH1.PRN		8452	SEP-09-1998 11:05:16
	DS3.PRN		8616	SEP-09-1998 10:45:22
	SDH4.PRN		11158	SEP-09-1998 11:11:20
	SHG1.PRN		16888	SEP-09-1998 13:12:10
F	34HB.PRN		10584	SEP-09-1998 12:34:54
	LINK1.PRN		5156	SEP-09-1998 12:52:14
	LINK3.PRN		7878	SEP-09-1998 12:55:36
	SDH2.PRN		8862	SEP-09-1998 12:59:18
	SDH3.PRN		11076	SEP-09-1998 13:11:50
L	DS1.PRN		5254	SEP-09-1998 13:04:18
L	PIH1.PRN		2135	SEP-09-1998 13:09:12
L	PIH2.PRN		7632	SEP-09-1998 13:10:28
L	LINK2.PRN		2135	SEP-09-1998 13:18:34
	LINK4.PRN		8090	SEP-09-1998 13:19:54
	LINK4.PRN		2135	SEP-09-1998 13:20:36
A	LOCAL.PRN		8101	SEP-09-1998 13:21:48
L	LONG1.PRN		2135	SEP-09-1998 13:22:22
	SDH7.PRN		8101	SEP-09-1998 13:24:26
	SDH8.PRN		2135	SEP-09-1998 13:24:48
	SDH9.PRN		6871	SEP-09-1998 13:25:32
	PIH3.PRN		2135	SEP-09-1998 13:26:10
	PIH4.PRN		6871	SEP-09-1998 13:26:32
	NEXT PAGE ->			

STATUS:

**MULTIPLE
WINDOW**

7 **NEW**. - Allows entry of new file name using pop-up keypad. Press **SET** to obtain the pop-up keypad display. Enter the new filename, Choose **END** and press **SET** to return to the file manager display.

8 Press **CANCEL** to return to the **SAVE** display.

The filename entered via the keypad appears on the **SAVE** display.

The file extension is added automatically.

The Directory name and the disk Label appear at the bottom of the display.

Using Instrument and Disk Storage

Managing Files and Directories on Disk

Renaming a File on Disk

Description

Files can be renamed as an aid to efficient file management.

FUNCTION	FLOPPY DISK
DISK OPERATION	FILE RENAME
FROM: NAME	FILENAME.CNF
TO: DIRECTORY NAME	A:\ FILENAME.CNF
Select OK to perform operation	<input type="checkbox"/> OFF
A:\ LABEL:	FREE: Bytes

STATUS:

OFF

OK

MULTIPLE
WINDOW

HOW TO:

- 1 Choose DISK OPERATION **FILE RENAME**.
- 2 Enter the FROM filename using **PREVIOUS CHAR** **NEXT CHAR** **→** **←** or Choose the directory which contains the file to be renamed. See "Accessing Directories and Files " page 284. Move the highlighted cursor to the file to be renamed and press **SET** to return to the **FILE RENAME** display. The filename, with extension, can contain up to 12 alphanumeric characters.
- 3 Choose the directory in which to locate the renamed file (it will appear on the display). See "Accessing Directories and Files " page 284.
- 4 Enter the TO filename using **PREVIOUS CHAR** **NEXT CHAR** **→** **←** or press **SET** twice and use the pop-up keypad. The filename can contain up to 8 alphanumeric characters. The file extension is fixed to the FROM filename extension.
- 5 To rename the file choose **OK**.
If you have entered a filename which already exists, a warning "File exists - are you sure" you wish to continue is displayed.
If YES is selected, the data in the file will be overwritten. If NO is selected, the operation is aborted.
This allows you the opportunity to verify before renaming.

Using Instrument and Disk Storage

Managing Files and Directories on Disk

Deleting a File on Disk

Description

Obsolete files can be deleted as an aid to efficient file management.

FUNCTION	FLOPPY DISK	
DISK OPERATION	FILE DELETE DELETE FILE	
NAME	FILENAME.EXT	
Select OK to perform operation	<input type="checkbox"/> OFF	
A:\ LABEL:	FREE:	Bytes

STATUS:

OFF

OK

MULTIPLE
WINDOW

HOW TO:

- 1 Choose DISK OPERATION **FILE** **DELETE** **DELETE FILE**.
- 2 Choose the directory containing the file to be deleted. See "Accessing Directories and Files " page 284.
- 3 Enter the filename to be deleted using **PREVIOUS CHAR** **NEXT CHAR** **←** **→** or press **SET**, highlight the file to be deleted on the file manager display, and press **SET**.
The file name can contain up to 12 alphanumeric characters, including the filename extension.
- 4 To delete the file choose **OK**.
A warning "Are you sure you wish to continue" is displayed.
If YES is selected, the file is deleted.
If NO is selected, the operation is aborted.
This prevents accidental deletion of a wanted file.

Using Instrument and Disk Storage

Managing Files and Directories on Disk

Deleting a Directory on Disk

Description

Obsolete directories should be deleted as an aid to efficient file management.

FUNCTION	FLOPPY DISK	
DISK OPERATION	FILE DELETE	DELETE DIRECTORY
Select OK to perform operation	<input type="checkbox"/> OFF	
A:\ LABEL:	FREE:	Bytes

STATUS:
 OFF OK

MULTIPLE WINDOW

NOTE

A directory cannot be deleted until all the files within the directory have been deleted. See "Deleting a File on Disk " page 287.

HOW TO:

- 1 Choose the directory you wish to delete (it will appear on the display). See "Accessing Directories and Files " page 284.
- 2 Choose DISK OPERATION FILE DELETE DELETE DIRECTORY.
- 3 To delete the directory choose OK.
A warning "Are you sure you wish to continue" is displayed.
If YES is selected, the directory is deleted.
If NO is selected, the operation is aborted.
This prevents accidental deletion of a wanted directory.
If the directory is not empty the messages "delete directory failed" "directory is not empty" are displayed.
- 4 If files need to be deleted to prepare the directory for deletion. See "Deleting a File on Disk " page 287.

Using Instrument and Disk Storage

Managing Files and Directories on Disk

Adding Descriptors to Disk Files

Description

When storing configurations or graphics on disk, you can give them an easily remembered descriptor for identification at a later date.

Descriptors can be added to .CNF and .SMG files.

FUNCTION	FLOPPY DISK
DISK OPERATION	FILE PROPERTIES
DISPLAY OPTION	FILE DESCRIPTOR
FILE NAME DESCRIPTOR	FILENAME.CNF
Press SET to select filename popup	
Select OK to perform operation	OFF
A:\ LABEL:	FREE: Bytes

STATUS:

TIME & DATE

FILE DESC

MULTIPLE WINDOW

HOW TO:

- 1 Choose the directory containing the file you wish to add the descriptor to. See "Accessing Directories and Files " page 284.
- 2 Choose DISK OPERATION **FILE PROPERTIES** and DISPLAY OPTION **FILE DESCRIPTOR**.
- 3 Move the highlighted cursor to the FILE NAME DESCRIPTOR field. Enter the file descriptor using **PREVIOUS CHAR** **NEXT CHAR** **→** **←** or press **SET**, highlight the file required on the file manager display, and press **SET**.
- 4 Move the highlighted cursor to Select OK to perform operation and choose OK. The File List will show the descriptor instead of the TIME and DATE information as long as FILE DESCRIPTOR is selected.

NOTE

This slows down the updating of the display.

Saving Graphical Results to Disk

Description

Graphical results can be saved to a file on disk. Two methods of naming the file, which is created when the measurement is started, are available:

- Automatic** A filename in the form meas001 is created automatically without any action from you.
- Your Choice** You can input a filename of your choice which will override the automatically generated filename. This must be entered before the measurement is started. If the filename you enter already exists, graphics results will be saved to the automatically generated filename. This prevents existing files from being overwritten each time the measurement is started.

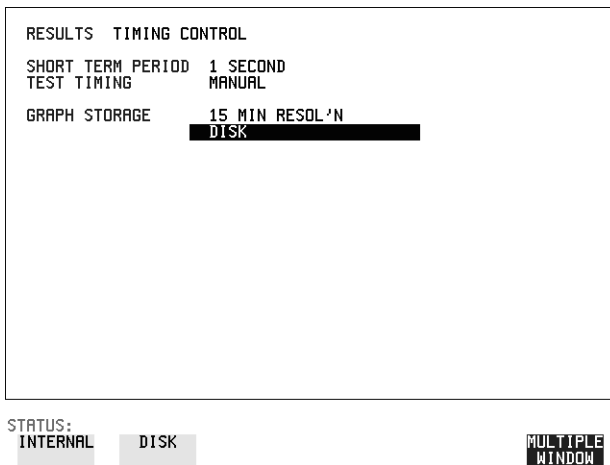

HOW TO:

- 1 Choose GRAPH STORAGE **DISK** and the Graph Storage resolution required on the **RESULTS** display. See “Saving Graphics Results to Instrument Store” page 244.
If you wish to use the automatically generated filename no further action is required and the graphics results will be saved on Disk when the measurement is completed.

Using Instrument and Disk Storage

Saving Graphical Results to Disk

FUNCTION	FLOPPY DISK	
DISK OPERATION	SAVE	
FILE TYPE	GRAPHICS	
NAME	FILENAME.SMG	
A:\ LABEL:	FREE:	Bytes

STATUS:

CONFIG-
URATION

GRAPHICS

DATA
LOGGING

MULTIPLE
WINDOW

- 2 Choose the directory in which to save the graphics results. See "Accessing Directories and Files " page 284.
- 3 If you wish to enter your own choice of filename, choose DISK OPERATION **SAVE** FILE TYPE **GRAPHICS**.
- 4 Move the highlighted cursor to NAME and enter the filename using **PREVIOUS CHAR** **NEXT CHAR** **→** **←** or press **SET** twice and use the pop-up keypad.
The filename can contain up to 8 alphanumeric characters.
The filename extension is fixed as .SMG.
The graphics results will be saved on Disk at the end of the measurement.

Using Instrument and Disk Storage

Saving a Screen Dump to Disk

Saving a Screen Dump to Disk

Description

The chosen display may be stored on disk in bitmap format using the Screen Dump feature of the 37718A. Logging and Floppy Disk displays must be set up for screen dump. See, "Logging on Demand" page 261. The current display is stored on disk when **PRINT NOW** is pressed.

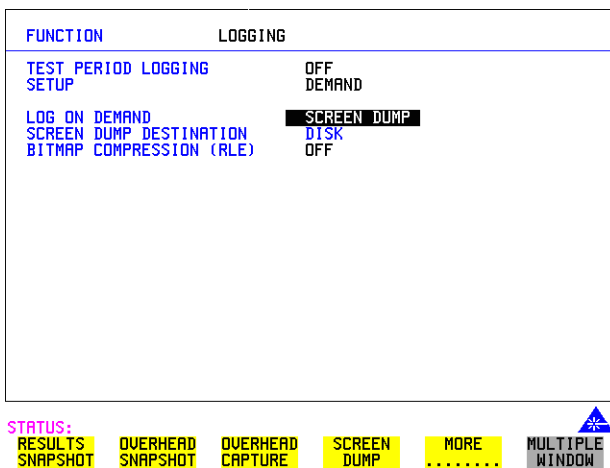

HOW TO:

- 1 Select the **OTHER** **LOGGING** display, and choose SETUP **LOGGING DEVICE** and LOGGING PORT **DISK**.
- 2 Now set SETUP to **LOG ON DEMAND** and LOG ON DEMAND to **SCREEN DUMP**.
- 3 If compression is required to save disk space, select BITMAP COMPRESSION (RLE) **ON**.

Using Instrument and Disk Storage

Saving a Screen Dump to Disk

FUNCTION	FLOPPY DISK
DISK OPERATION	SAVE
FILE TYPE NAME	SCREEN DUMP FILENAME.BMP
BMP DIR : A:\ BMP FILE: SDUMP029.BMP	
A:\ LABEL:no label	FREE: unknown Bytes

STATUS:
STORED SETTINGS FLOPPY DISK LOGGING MORE MULTIPLE WINDOW

- 4 Choose the directory in which to save the Screen Dump. See "Accessing Directories and Files " page 284.
- 5 If you wish to enter your own choice of filename, choose DISK OPERATION **SAVE** FILE TYPE **SCREEN DUMP**.

NOTE

You have the option of an auto generated filename or entering your chosen filename. The file name can have a maximum of 8 characters. The file extension is fixed as .BMP. The file name must satisfy DOS requirements, that is, there must be no spaces or other illegal characters.

- 6 Move the highlighted cursor to NAME and enter the filename using **PREVIOUS CHAR** **NEXT CHAR** **→** **←** or press **SET** twice and use the pop-up keypad.
- 7 Choose the display you want to store on disk and press **PRINT NOW**. After a few second the message "SAVING SCREEN DUMP . . . (XX% COMPLETE)" is displayed.

Saving Data Logging to Disk

Description

Data Logging can be saved to a file on disk. The disk can be transferred to a personal computer (PC) and the logging investigated at a later date.

FUNCTION	FLOPPY DISK
DISK OPERATION	SAVE
FILE TYPE NAME	DATA LOGGING FILENAME.PRN APPEND TO FILE
A:\ LABEL:	FREE: Bytes

STATUS:

OVER-
WRITE

APPEND
TO FILE

MULTIPLE
WINDOW

HOW TO:

- 1 Choose the directory in which to save the logging results. See "Accessing Directories and Files " page 284.
- 2 Choose DISK OPERATION **SAVE** FILE TYPE **DATA LOGGING** and enter your choice of filename using **PREVIOUS CHAR** **NEXT CHAR** **→** **←** or press **SET** twice and use the pop-up keypad.
The filename can contain up to 8 alphanumeric characters.
The filename extension is fixed as .PRN.
- 3 If you wish to add the data logging to a file which already exists, choose **APPEND TO FILE**. The data logging is added to the named file on Disk in the available free space.
If you wish to overwrite the contents of the named file with the data logging, choose **OVERWRITE**.
- 4 Set up the **OTHER LOGGING** display. See "Logging Results" page 253.
When the named file is opened, data logging is saved on the disk:
As each logging output occurs during the measurement or when **PRINT NOW** is pressed.

Using Instrument and Disk Storage

Saving Configurations to Disk

Saving Configurations to Disk

Description

You can store a large number of measurement settings which are used regularly and recall them when required.

Configurations can be stored to a file on the floppy disk. The floppy disk can be used in other instruments which have the same option structure.

FUNCTION	FLOPPY DISK
DISK OPERATION	SAVE
FILE TYPE NAME	CONFIGURATION SDHARNAI .CNF
Select OK to perform operation	OFF
A:\ LABEL:no label	FREE: 1148928 Bytes

STATUS: CONFIG-URRATION GRAPHICS DATA LOGGING SCREEN DUMP MULTIPLE WINDOW

HOW TO:

- 1 Set the OmniBER 718 to the configuration you wish to store.
- 2 Choose the directory in which you wish to save the OmniBER 718 configuration. See "Accessing Directories and Files " page 284.
- 3 Choose DISK OPERATION **SAVE**, FILE TYPE **CONFIGURATION** and enter the filename using **PREVIOUS CHAR** **NEXT CHAR** **→** **←** or press **SET** twice and use the pop-up keypad.
The filename extension is fixed as .CNF.
The filename can contain up to 8 alphanumeric characters.
- 4 Choose **OK** to save the current configuration to disk.
If you have entered a filename which already exists, a warning "File exists - are you sure you wish to continue" is displayed.
If YES is selected, the configuration will be saved.
To cancel, change OK to OFF and enter new filename. See "Accessing Directories and Files " page 284.

Recalling Configuration from Disk

Description

If a configuration has been stored on disk, you will need to recall it at some time in the future to configure the instrument.

FUNCTION	FLOPPY DISK	
DISK OPERATION	RECALL	
FILE TYPE NAME	CONFIGURATION FILENAME.CNF	
Select OK to perform operation	OFF	
A:\ LABEL:	FREE:	Bytes

STATUS:

CONFIG-
URATION

GRAPHICS

MULTIPLE
WINDOW

HOW TO:

- 1 Choose the directory that contains the configuration file to be recalled. See "Accessing Directories and Files " page 284.
- 2 Choose DISK OPERATION **RECALL** FILE TYPE **CONFIGURATION** and enter your choice of filename using **PREVIOUS CHAR** **NEXT CHAR** **→** **←**.
The filename can contain up to 8 alphanumeric characters.
The filename extension is fixed as .CNF.
- 3 To recall the configuration from disk to instrument, choose **OK**.
The recall operation can be verified by checking the relevant display settings.

Using Instrument and Disk Storage

Recalling Graphics Results from Disk

Recalling Graphics Results from Disk

Description

If graphic results have been stored on disk, you will need to recall them in able to view the results on the **(GRAPH)** display.

FUNCTION	FLOPPY DISK
DISK OPERATION	RECALL
FILE TYPE NAME	GRAPHICS FILENAME.SMG
Select OK to perform operation	<input type="checkbox"/> OFF
A:\ LABEL:	FREE: Bytes

STATUS:

OFF

OK

MULTIPLE
WINDOW

HOW TO:

- 1 Choose the directory that contains the graphics file to be recalled. See "Accessing Directories and Files " page 284.
- 2 Choose DISK OPERATION **RECALL** FILE TYPE **GRAPHICS** and enter your choice of filename using **PREVIOUS CHAR** **NEXT CHAR** **→** **←**. The filename can contain up to 8 alphanumeric characters. The filename extension is fixed as .SMG.
- 3 To recall the graphics results from disk to instrument, choose **OK**.
- 4 To view the graphics results, see "Recalling Stored Graph Results" page 245.

Copying Configuration from Instrument Store to Disk

Description

If you have a configuration stored in the instrument store that you wish to use on another instrument, you can copy it to disk. The configuration can then be downloaded from the disk in to another OmniBER 718 with the same options as the original instrument.

FUNCTION	FLOPPY DISK
DISK OPERATION	FILE COPY CONFIGURATION
FROM: 1 ATM27.....	
TO: NAME	FILENAME.CNF
Select OK to perform operation	<input type="checkbox"/> OFF
A:\ LABEL:	FREE: Bytes

STATUS:

OFF

OK

MULTIPLE WINDOW

HOW TO:

- 1 Choose the directory to receive the configuration file. See "Accessing Directories and Files " page 284.
- 2 Choose DISK OPERATION **FILE COPY CONFIGURATION** and enter the Instrument Store number using **DECREASE DIGIT** and **INCREASE DIGIT** or press **SET** and use the pop-up keypad.
The Stored Settings description appears alongside the store number.
If required the description can be modified using **JUMP NEXT CHAR** **PREVIOUS CHAR** **←** **→** or press **SET** and use the pop-up keypad.
The description can contain up to 24 alphanumeric characters.
- 3 Enter the chosen filename using **PREVIOUS CHAR** **NEXT CHAR** **→** **←** or press **SET** twice and use the pop-up keypad.
The file name can contain up to 8 alphanumeric characters.
The filename extension is fixed as .CNF.

Using Instrument and Disk Storage

Copying Configuration from Instrument Store to Disk

- 4 To copy the configuration from instrument to Disk choose **OK**.
If you have entered a filename which already exists, a warning "File exists - are you sure you wish to continue" is displayed.
If YES is selected, the data on the Disk will be overwritten.
If NO is selected, the operation is aborted.

Copying Configuration from Disk to Instrument Store

Description

If you have a configuration stored in the instrument store that you wish to use on another instrument, you can copy it to Disk. The configuration can then be downloaded from the disk in another OmniBER 718 with the same options as the original instrument.

FUNCTION	FLOPPY DISK
DISK OPERATION	FILE COPY CONFIGURATION
TO:	4 ATMTEST.....
FROM:	NAME FILENAME.CNF
Select OK to perform operation <input type="checkbox"/> OFF	
A:\ LABEL:	FREE: Bytes

STATUS:
 OFF OK MULTIPLE WINDOW

HOW TO:

- 1 Choose the directory containing the configuration file. See "Accessing Directories and Files" page 284.
- 2 Choose DISK OPERATION **FILE COPY CONFIGURATION** and enter the Instrument Store number using **DECREASE DIGIT** and **INCREASE DIGIT** or press **SET** and use the pop-up keypad.
Enter a description of the configuration using **PREVIOUS CHAR** **NEXT CHAR** **→** **←** or press **SET** and use the pop-up keypad.
The description can contain up to 24 alphanumeric characters.
- 3 Enter the filename the configuration is to be copied from using **PREVIOUS CHAR** **NEXT CHAR** **→** **←** or press **SET**, highlight the file to be copied on the file manager display and press **SET**.
The file name can contain up to 8 alphanumeric characters.
The filename extension is fixed as .CNF.

Using Instrument and Disk Storage

Copying Configuration from Disk to Instrument Store

- 4 To copy the configuration from Disk to instrument, choose **OK**.
If you have entered a instrument store number which already contains a configuration, a warning "Are you sure you wish to continue" is displayed.
If YES is selected, the data in the instrument store will be overwritten.
If NO is selected, the operation is aborted.

Copying Graphics Results from Instrument Store to Disk

Description

You can copy Graphics Results from the instrument store to the Disk. This is useful under the following conditions:

- If you have graphics results stored in the instrument that you wish to prevent from being overwritten by a future measurement (only 10 store locations in the instrument)
- If you wish to retrieve the graphics results for viewing via a spreadsheet.

FUNCTION	FLOPPY DISK
DISK OPERATION	FILE COPY GRAPHICS
FROM: STORE	-9
TO: NAME FORMAT	FILENAME.SMG NORMAL
Select OK to perform operation	<input type="checkbox"/> OFF
A:\ LABEL:	FREE: Bytes

STATUS:

 OFF OK MULTIPLE WINDOW

HOW TO:

- 1 Choose the directory to receive the graphics file. See "Accessing Directories and Files" page 284.
- 2 Choose DISK OPERATION **FILE COPY GRAPHICS** and enter the Instrument Store number using **DECREASE DIGIT** and **INCREASE DIGIT** or press **SET** and use the pop-up keypad.
- 3 Enter the filename the graphic results are to be copied to using **PREVIOUS CHAR** **NEXT CHAR** **→** **←** or press **SET** twice and use the pop-up keypad.
The file name can contain up to 8 alphanumeric characters.
The filename extension is fixed as .SMG.

Using Instrument and Disk Storage

Copying Graphics Results from Instrument Store to Disk

- 4** If you wish to view the graphic results at a later date via a spreadsheet, choose FORMAT **CSV**. CSV is Comma Separated Variable.
If you wish to view the graphic results at a later date on an OmniBER 718, choose FORMAT **NORMAL**.
- 5** To copy the configuration from instrument to Disk, choose **OK**.
If you have entered a filename which already exists, a warning "File exists - are you sure you wish to continue" is displayed.
If YES is selected, the data on the Disk will be overwritten.
If NO is selected, the operation is aborted.
This allows you the opportunity to view the data on the Disk and verify that it is no longer needed.

Using Instrument and Disk Storage

Copying Graphics Results from Instrument Store to Disk

- “Coupling Transmit and Receive Settings” page 306
- “Setting Time & Date” page 307
- “Enabling Keyboard Lock” page 308
- “Enabling Beep on Received Error” page 309
- “In-Band DS1 Loopcode 156MTS Compatibility” page 310
- “Suspending Test on Signal Loss” page 311
- “MS-REI Result/Enable” page 312
- “Graph Storage Resolution” page 314
- “Setting Error Threshold Indication” page 315
- “Setting Screen Brightness and Color” page 316
- “To change the parameters of a User-defined jitter mask” page 319
- “To Generate a New Jitter Mask” page 317
- “Running Self Test” page 321
- “Trigger Output ” page 324

Selecting and Using "Other" Features

Selecting and Using "Other" Features

Coupling Transmit and Receive Settings

Coupling Transmit and Receive Settings

Description

When generating and measuring at the same interface level, you can have the transmit and receive settings coupled together. Any settings change made on the transmit display will automatically occur on the receive display. Any settings change made on the receive display will automatically occur on the transmit display.

This function is available on the **OTHER SETTINGS CONTROL** display.

FUNCTION	SETTINGS CONTROL
TRANSMITTER AND RECEIVER	COUPLED
RECEIVER COUPLED TO TRANSMITTER	

STATUS:
INDEP-
ENDENT

COUPLED

MULTIPLE
WINDOW

HOW TO:

- 1 Choose TRANSMITTER AND RECEIVER **COUPLED**.

Setting Time & Date

Setting Time & Date

Description

When making Bit error measurements and recording results you can have certain events timed chronologically, for example, Alarms; Error Seconds.

The capability to set the Time and Date is provided on the **OTHER TIME & DATE** display.

FUNCTION	TIME & DATE
CLOCK MODE	SETUP
TIME	05:22:59
DATE	29-JUL-89

STATUS: DECREASE DIGIT INCREASE DIGIT ← → MULTIPLE WINDOW

HOW TO:

- 1 Choose CLOCK MODE **SETUP** and set the Time and Date using **↑**; **↓**; **←**; **→**; **INCREASE DIGIT** and **DECREASE DIGIT**.
- 2 Choose CLOCK MODE **RUN** to complete the setting of Time and Date.

Selecting and Using "Other" Features

Enabling Keyboard Lock

Enabling Keyboard Lock

Description

You can protect the measurement settings from interference during a test.

This function is provided in the OmniBER 718 on the **OTHER** **MISCELLANEOUS** display.

The following keys are not affected by Keyboard Lock:

- Display keys **TRANSMIT**; **RECEIVE**; **RESULTS**; **GRAPH**; **OTHER**
- cursor keys **←** **↑** **↓** and **→**
- **SHOW** **PAPER FEED** **LOCAL** **SMART TEST**

The following display functions are not affected by Keyboard Lock:

- RESULTS type on the **RESULTS** display
- KEYBOARD LOCK on the **OTHER** display

FUNCTION	MISCELLANEOUS
KEYBOARD LOCK	ON
BEEP ON RECEIVED ERROR	OFF
INBAND DS1 LOOPCODE	
156MTS COMPATIBILITY	OFF
SUSPEND TEST ON SIGNAL LOSS	OFF
MS-REI RESULT ENABLE	OFF
MS-AIS RESULT ENABLE	OFF
GRAPH STORAGE RESOLUTION	COMPRESS
NOTE: storing graph results with full resolution will reduce storage capacity by 50%	

STATUS:

OFF ON



HOW TO:

- 1 Choose KEYBOARD LOCK **ON**.

Selecting and Using "Other" Features

Enabling Beep on Received Error

Enabling Beep on Received Error

Description

You can have an audible indication of an error which is particularly useful when the display on the test set is hidden from view.

This function is provided in the OmniBER 718 on the **OTHER** **MISCELLANEOUS** display.

FUNCTION	MISCELLANEOUS
KEYBOARD LOCK	ON
BEEP ON RECEIVED ERROR	OFF
INBAND DS1 LOOPCODE	
156MTS COMPATIBILITY	OFF
SUSPEND TEST ON SIGNAL LOSS	OFF
MS-REI RESULT ENABLE	OFF
MS-RIS RESULT ENABLE	OFF
GRAPH STORAGE RESOLUTION	COMPRESS
NOTE: storing graph results with full resolution will reduce storage capacity by 50%	

STATUS:

OFF

ON



HOW TO:

- 1 Choose BEEP ON RECEIVED ERROR **ON**.

Selecting and Using "Other" Features

In-Band DS1 Loopcode 156MTS Compatibility

In-Band DS1 Loopcode 156MTS Compatibility

Description

The instrument default state is with the INBAND DS1 LOOPCODE 156MTS COMPATIBILITY field set to **OFF**. In this mode the instrument operates as per the T1.403.CORE standard which states that the DS1 framing bit should overwrite the DS1 Loopcode pattern. When **ON** is selected the instrument operation changes such that DS1 Loopcode is gapped in order to prevent the DS1 framing bit overwriting the DS1 Loopcode pattern. This is compatible with HP's 156MTS T-carrier and SONET tester.

FUNCTION	MISCELLANEOUS
KEYBOARD LOCK	ON
BEEP ON RECEIVED ERROR	OFF
INBAND DS1 LOOPCODE 156MTS COMPATIBILITY	OFF
SUSPEND TEST ON SIGNAL LOSS	OFF
MS-REI RESULT ENABLE	OFF
MS-AIS RESULT ENABLE	OFF
GRAPH STORAGE RESOLUTION	COMPRESS
NOTE: storing graph results with full resolution will reduce storage capacity by 50%	

STATUS:

OFF

ON



MULTIPLE
WINDOW

Selecting and Using "Other" Features

Suspending Test on Signal Loss

Suspending Test on Signal Loss

When running a test, you can choose to suspend the test during periods of signal loss.

This function is available on the **OTHER** **MISCELLANEOUS** display.

FUNCTION	MISCELLANEOUS
KEYBOARD LOCK	ON
BEEP ON RECEIVED ERROR	OFF
INBAND DS1 LOOPCODE	
156MTS COMPATIBILITY	OFF
SUSPEND TEST ON SIGNAL LOSS	OFF
MS-REI RESULT ENABLE	OFF
MS-RIS RESULT ENABLE	OFF
GRAPH STORAGE RESOLUTION	COMPRESS
NOTE: storing graph results with full resolution will reduce storage capacity by 50%	

STATUS:

OFF

ON



HOW TO:

- 1 Choose SUSPEND TEST ON SIGNAL LOSS **ON**.

Selecting and Using "Other" Features

MS-REI Result/Enable

MS-REI Result/Enable

Before running a test, you can choose to enable or disable the SDH measurement of MS-REI or the equivalent SONET measurement of REI-L.

This function is available on the **OTHER** **MISCELLANEOUS** display.

FUNCTION	MISCELLANEOUS
KEYBOARD LOCK	ON
BEEP ON RECEIVED ERROR	OFF
INBAND DS1 LOOPCODE 156MTS COMPATIBILITY	OFF
SUSPEND TEST ON SIGNAL LOSS	OFF
MS-REI RESULT ENABLE	OFF
MS-RIS RESULT ENABLE	OFF
GRAPH STORAGE RESOLUTION	COMPRESS
NOTE: storing graph results with full resolution will reduce storage capacity by 50%	

STATUS: **OFF** **ON**

MULTIPLE WINDOW 

HOW TO:

- 1 Choose MS-REI ENABLE **ON** or **OFF** as required.

When set to **OFF**, the MS-REI and REI-L measurements are suppressed. Cumulative, Short Term and Analysis measurements are affected alike.

The MS-REI measurement is twinned with B2-BIP with regard to the G.826 PUAS measurement. This results in the B2-BIP PUAS measurement showing **N/A** when MS-REI is set to **OFF**.

MS-AIS Result/Enable

MS-AIS Result/Enable

Before running a test, you can choose to enable or disable the SDH measurement of MS-AIS or the equivalent SONET measurement of AIS-L.

This function is available on the **OTHER MISCELLANEOUS** display.

FUNCTION	MISCELLANEOUS
KEYBOARD LOCK	ON
BEEP ON RECEIVED ERROR	OFF
INBAND DS1 LOOPCODE 156MTS COMPATIBILITY	OFF
SUSPEND TEST ON SIGNAL LOSS	OFF
MS-REI RESULT ENABLE	OFF
MS-AIS RESULT ENABLE	OFF
GRAPH STORAGE RESOLUTION	COMPRESS
NOTE: storing graph results with full resolution will reduce storage capacity by 50%	

STATUS: OFF ON

MULTIPLE WINDOW

HOW TO:

- 1 Choose MS-AIS ENABLE **ON** or **OFF** as required.

When set to **OFF**, the MS-AIS and AIS-L measurements are suppressed. Cumulative, Short Term and Analysis measurements are affected alike.

Selecting and Using "Other" Features

Graph Storage Resolution

Graph Storage Resolution

Description

The total graphics store capacity is normally 20,000 events. If GRAPH STORAGE RESOLUTION **FULL** is selected the capacity reduces to 10,000 events.

FUNCTION	MISCELLANEOUS
KEYBOARD LOCK	ON
BEEP ON RECEIVED ERROR	OFF
INBAND DS1 LOOPCODE	
156MTS COMPATIBILITY	OFF
SUSPEND TEST ON SIGNAL LOSS	OFF
MS-REI RESULT ENABLE	OFF
MS-AIS RESULT ENABLE	OFF
GRAPH STORAGE RESOLUTION	COMPRESS
NOTE: storing graph results with Full resolution will reduce storage capacity by 50%	

STATUS:

COMPRESS

FULL



MULTIPLE WINDOW

Selecting and Using "Other" Features

Setting Error Threshold Indication

Setting Error Threshold Indication

Description

When making error measurements, you can have an indication of when an error count or error ratio threshold has been exceeded. You can set the OmniBER 718 to indicate this by a color change, from yellow to red, of the bar on the **GRAPH** display and the result on the **RESULTS** display. You can choose the thresholds at which the color change occurs.

The Count and Ratio selections are independent.

This function is available on the **OTHER COLOR CONTROL** display.

FUNCTION	COLOR CONTROL
COLOR ENHANCE RESULTS	ON
COUNT THRESHOLD	10000
RATIO THRESHOLD	10 ⁻³
COLOR PALETTE	TWO
DISPLAY BRIGHTNESS	FULL

STATUS:
10⁻³ 10⁻⁶ 10⁻⁷ 10⁻⁸ 10⁻⁹ **MULTIPLE WINDOW**

HOW TO:

- 1 Choose COLOR ENHANCE RESULTS **ON**.
- 2 Choose the COUNT THRESHOLD and RATIO THRESHOLD.

Selecting and Using "Other" Features

Setting Screen Brightness and Color

Setting Screen Brightness and Color

Description

The OmniBER 718 screen can be set to single or two color using the COLOR PALETTE selection on the **OTHER**, **COLOR CONTROL** display.

The screen brightness can be set to full or half brightness.

The half brightness setting is used when the room brightness is such that half brightness is desirable and will also prolong the life of the screen.

If the brightness is set to FULL and there have been no key presses in the last hour, then the screen automatically dims to the half brightness level and the status message "Display set to half brightness" is shown. Any key press will return the screen to full brightness.

This function is available on the **OTHER**, **COLOR CONTROL** display.

The function of the COUNT THRESHOLD and RATIO THRESHOLD fields is explained on the previous page.

FUNCTION	COLOR CONTROL
COLOR ENHANCE RESULTS	ON
COUNT THRESHOLD	10000
RATIO THRESHOLD	10^-3
COLOR PALETTE	TWO
DISPLAY BRIGHTNESS	FULL

STATUS:

HALF

FULL

**MULTIPLE
WINDOW**

HOW TO:

- 1 Choose the DISPLAY BRIGHTNESS to suit the operating environment.

Selecting and Using "Other" Features To Generate a New Jitter Mask

To Generate a New Jitter Mask

This feature enables the user to quickly generate a new mask, without having to set each point in the mask. The procedure is as follows:

- 1 Select **OTHER**, **JITTER MASKS**, you will have to select **MORE** to access the JITTER MASKS key.
- 2 Check the mask LOCK is set to **OFF**, then select a USER MASK NUMBER (from 1 to 5). Note that it is not possible to edit a User Mask when there is a User Mask currently in use (i.e. when running a measurement). When this occurs the LOCK field displays "ON (IN USE)".

- 3 Position the cursor on DISPLAY and select **GENERATE MASK**.
- 4 Position the cursor on POINTS and set the required number of points in the mask.

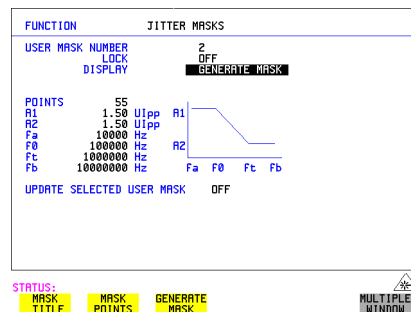

- 5 Using the **↑**, **↓** and edit keys setup the amplitude and frequency of the user-selectable points given on the display (i.e. A1, A2 fa, f0, ft, fb).
- 6 Position the cursor on the UPDATE SELECTED USER MASK field and select **GENERATE**.

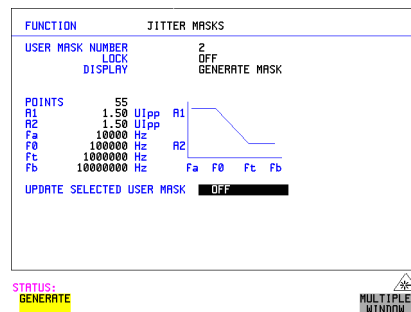

NOTE

A status message "Illegal mask parameters" will occur if the specified frequency and amplitude points are invalid. Check that the frequency points are in ascending order and that the A1 and A2 amplitudes are valid for the specified frequencies.

Selecting and Using "Other" Features

To Generate a New Jitter Mask

- 7 Select DISPLAY **MASK POINTS**.

Note that the GENERATE action has resulted in a new mask being calculated and placed into the frequency and amplitude fields. Further editing can now take place as required, using the edit keys.

For example, selecting NUMBER OF POINTS will allow you to change the number of points in the mask, while selecting PAGE enables you to select pages 1 to 5 and edit the frequency and amplitude of each point on the mask.

FUNCTION		JITTER MASKS			
USER MASK NUMBER		1			
LOCK		OFF			
DISPLAY		MASK POINTS			
NUMBER OF POINTS		50			
PAGE		1			
	FREQ(Hz)	AMP(UI)		FREQ(Hz)	AMP(UI)
01	9989	1.30	07	23277	1.30
02	11502	1.30	08	25802	1.30
03	13243	1.30	09	30860	1.30
04	15248	1.30	10	35533	1.30
05	17557	1.30	11	40913	1.30
06	20216	1.30	12	47108	1.30

STATUS: MASK TITLE MASK POINTS GENERATE MASK

MULTIPLE WINDOW

- 8 The new edits are automatically saved into the mask selected, there is no need to generate a new mask.

Locking the Mask

To prevent accidental changes to the masks when finished set the LOCK to **ON**.

To change the parameters of a User-defined jitter mask

To change the parameters of a User-defined jitter mask

- 1 Select **OTHER**, and set FUNCTION to **JITTER MASKS**; you will have to select **MORE** to access the JITTER MASKS key.

To Edit a User Mask Title

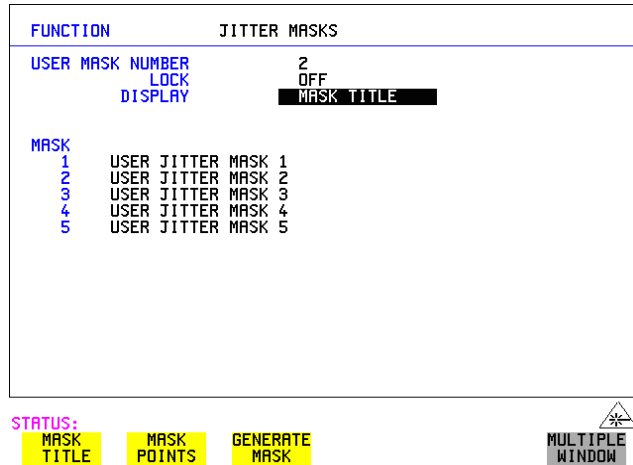

- 2 Check the mask LOCK is set to **OFF**, then select USER MASK NUMBER, and select the appropriate user mask (1 to 5).
- 3 Position the cursor on DISPLAY, then select **MASK TITLE**.
- 4 Position the cursor on the MASK (1 to 5) to be edited, and enter a new title using the edit keys.



Selecting and Using "Other" Features

To change the parameters of a User-defined jitter mask

To Edit Mask Points

- 1 Position the cursor on DISPLAY and select **MASK POINTS**.
- 2 Select NUMBER OF POINTS and using the ,  keys, and edit keys (INCREASE/DECREASE DIGIT) select the number of points in the mask (maximum 55) and the frequency and amplitude at each point. Use the PAGE field to switch between pages to access all 55 points in the mask.

FUNCTION		JITTER MASKS									
USER MASK NUMBER						2					
LOCK						OFF					
DISPLAY						MASK POINTS					
NUMBER OF POINTS						55					
PAGE						1					
	FREQ(Hz)	AMP(UI)		FREQ(Hz)	AMP(UI)						
01	200	1.50	07	592	1.27						
02	240	1.50	08	710	1.06						
03	287	1.50	09	850	0.89						
04	344	1.50	10	1019	0.75						
05	412	1.50	11	1221	0.63						
06	494	1.50	12	1463	0.52						

STATUS: **MASK TITLE** **MASK POINTS** **GENERATE MASK**  MULTIPLE WINDOW

- 3 Note that it is not possible to edit a user mask when a user mask is currently in use (i.e. a measurement is running). When this occurs the LOCK field displays "ON (IN USE)".
- 4 The new edits are automatically saved into the mask selected, there is no need to generate a new mask.

Selecting and Using "Other" Features

Running Self Test

Running Self Test

Description

Before using the OmniBER 718 to make measurements, you can run Self Test ALL TESTS to ascertain the integrity of the OmniBER 718. These tests take at least 1 hour to complete depending on the options fitted.

Alternatively you can run Confidence Tests which only takes 2 to 3 minutes to complete. This is not a full verification but performs BER measurements with internal and external loopbacks fitted.

FUNCTION	SELF TEST
TEST TYPE	ALL TESTS
TEST NUMBER	0
SUBTEST NUMBER	---
TEST STATUS	READY
PRESS THE (RUN/STOP) KEY TO START TESTING.	
CABLING INFO	ALL

STATUS:
ALL TESTS CPU TESTS CONF. TESTS PDH TESTS MORE MULTIPLE WINDOW

HOW TO:

Run ALL TESTS

- 1 Choose TEST TYPE **ALL TESTS** on the **(OTHER) SELF TEST** display.
- 2 Insert a formatted disk into the instrument disk drive.
- 3 Make the loopback connections listed below:
 - Connect Transmit module 75Ω OUT to Receive module 75Ω IN
 - Connect Transmit module 100/120Ω OUT to Receive module 100/120Ω IN
 - Connect Transmit module 75Ω MUX to Receive module 75Ω DEMUX
 - Connect Transmit module 100/120Ω MUX to Receive module 100/120Ω DEMUX
 - Connect Multirate Analyzer IN to OUT
 - Connect Optical OUT to Optical IN via a 15 dB attenuator.

NOTE

If any or all of these connections are not made the OmniBER 718 will FAIL Self Test.

Selecting and Using "Other" Features

Running Self Test

- 4 Press **RUN/STOP** to activate the Self Test. TEST STATUS RUNNING will be displayed.

The information pertaining to TEST TYPE, TEST NUMBER and SUBTEST NUMBER will change as the Self Test progresses.

If the OmniBER 718 is functioning correctly, after a time of at least 1 hour, TEST STATUS PASSED is displayed.

If TEST STATUS [FAIL nnn] is displayed, the OmniBER 718 should be returned to a service office for repair.

FUNCTION	SELF TEST
TEST TYPE	CONFIDENCE TEST
TEST NUMBER	2
SUBTEST NUMBER	---
TEST STATUS	PASSED
PRESS THE RUN/STOP KEY TO START TESTING.	
CABLING INFO	<input type="checkbox"/> CONF. TEST

STATUS:

ALL TESTS

CPU TESTS

CONF. TESTS

PDH TESTS

MORE
.....

MULTIPLE WINDOW

HOW TO:

Run Confidence TESTS

- 1 Choose TEST TYPE **CONF. TESTS** on the **OTHER SELF TEST** display.
- 2 Insert a formatted disk into the instrument disk drive.
- 3 Make the loopback connections listed below:
Connect Transmit module 75Ω OUT to Receive module 75Ω IN
Connect Transmit module 100/120Ω OUT to Receive module 100/120Ω IN
Connect Transmit module 75Ω MUX to Receive module 75Ω DEMUX
Connect Transmit module 100/120Ω MUX to Receive module 100/120Ω DEMUX
Connect Multirate Analyzer IN to OUT
Connect Optical OUT to Optical IN via a 15 dB attenuator.
- 4 Press **RUN/STOP** to activate the Self Test. TEST STATUS RUNNING will be displayed.
The information pertaining to TEST TYPE, TEST NUMBER and SUBTEST NUMBER will change as the Self Test progresses.
If the OmniBER 718 is functioning correctly, after a time of 2 to 3minutes, TEST

Selecting and Using "Other" Features

Running Self Test

STATUS PASSED is displayed.

If TEST STATUS [FAIL nnn] is displayed, the OmniBER 718 should be returned to a service office for repair.

NOTE

Each individual self test requires unique loopback connections. To obtain a list of the connections required move the highlighted cursor to CABLING INFO and press **SET**. The Loopbacks list will appear on the display.

FUNCTION	SELF TEST
TEST TYPE	PDH TESTS
TEST NUMBER	3
SUBTEST NUMBER	---
TEST STATUS	READY
<hr/> PDH SELFTEST - CABLING INFORMATION <hr/>	
PAYLOAD MODULE CONNECTIONS : CONNECT PDH OUT TO PDH IN (UNBALANCED DS3, 21k/s, 341k/s) CONNECT PDH OUT TO PDH IN (BALANCED 21k/s) CONNECT MUX TO DEMUX (BALANCED DS1) CONNECT MUX TO DEMUX (UNBALANCED 21k/s)	

STATUS:

**MULTIPLE
WINDOW**

Trigger Output

Trigger Output

Description

Use the pulse output from the TRIG OUT port on the OmniBER Multirate Analyzer module to trigger external equipment. A pulse is output whenever the condition selected in the TRIGGER SOURCE field occurs.

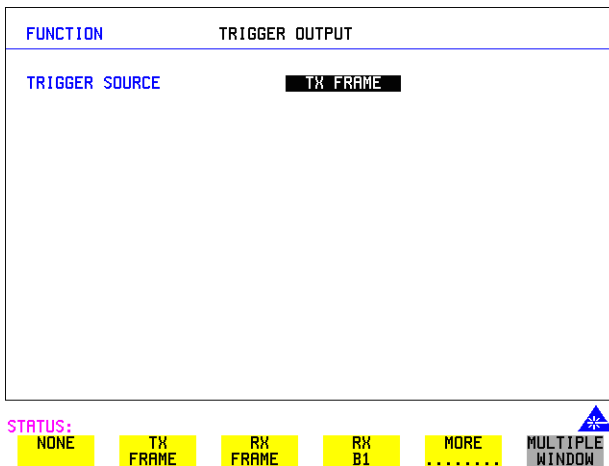

How To

- 1 Select **OTHER**, and set FUNCTION to **TRIGGER OUTPUT**.
- 2 Set the TRIGGER SOURCE field as required from the following:

NONE
 TX FRAME
 RX FRAME
 RX B1 (B1 error)
 RX B2 (B2 error) or
 RX B3 (B3 error)

Pulse Format

TTL Levels. Termination can be 75 ohm or 10 kohm.

RZ with active high pulse of 60usec (Nominal). Note that a single pulse is generated if a frame contains one or more errors giving a maximum frequency of 8kHz.

Connector

BNC.

Appendix A

AU-3/TUG-3 Background Patterns

The following tables list the background patterns available when selecting specific foregrounds.

Table 7 AU-3 Background Patterns

Foreground	Background choice in Foreground AU-3	Background choice in other AU-3s
AU-3	-----	TU-11, TU-12 Mapping or AU-3 Word (8 bit user programmable word).
TU-2	Pattern in other TU-2s is numbered. They contain the word 11NNNNNx, where NNNNN is the binary number of the TU.	TU-11, TU-12 Mapping or AU-3 Word (8 bit user programmable word).
TU-12 (2 Mb/s) Unframed	TU-12 structure, unframed with 2E15-1, 2E9-1 PRBS or 1100 word pattern in all information bits.	TU-12, TU-11 Mapping or AU-3 Word (8 bit user programmable word).
TU-12 (2 Mb/s) Framed	TU-12 structure, framed with 2E15-1, 2E9-1 PRBS, NUMBERED or 1100 word pattern. In Numbered mode, each timeslot contains the pattern 0NNNNNNX where NNNNNN is the binary number of the TU. The least significant digit (X) is alternated between 0 and 1 in successive frames.	TU-12, TU-11 Mapping or AU-3 Word (8 bit user programmable word).
TU-11 (DS1) Unframed	TU-11 structure, D4 framed with 2E15-1, 2E9-1 PRBS or 1100 Word pattern in other TU-11s.	TU-12, TU-11 Mapping or AU-3 Word (8 bit user programmable word).

Table 7 AU-3 Background Patterns, continued

Foreground	Background choice in Foreground AU-3	Background choice in other AU-3s
TU-11 (DS1) Framed	TU-11 structure, DS1, D4 framed with 2E15-1, 2E9-1 PRBS, NUMBERED or 1100 word pattern in other TU-11s. In Numbered mode, each timeslot contains the pattern 1NNNNNN1 where NNNNNN is the binary number of the TU. Framing type will be the same as the foreground except when SLC96 is selected. In this case, D4 framing is inserted in the background	TU-12, TU-11 Mapping or AU-3 Word (8 bit user programmable word).

Table 8 TUG-3 Background Patterns

Foreground	Background choice in Foreground TUG-3	Background choice in other TUG-3s
TUG-3	-----	TU-11, TU-12 Mapping or TU-3 Word (8 bit user programmable word).
TU-2	Pattern in other TU-2s is numbered. They contain the word 11NNNNNx, where NNNNN is the binary number of the TU.	
TU-12 (2 Mb/s) Unframed	TU-12 structure, unframed with 2E15-1, 2E9-1 PRBS or 1100 word pattern in all information bits.	TU-12, TU-11 Mapping or TU-3 Word (8 bit user programmable word).

Table 8 TUG-3 Background Patterns

Foreground	Background choice in Foreground TUG-3	Background choice in other TUG-3s
TU-12 (2 Mb/s) Framed	TU-12 structure, framed with 2E15-1, 2E9-1 PRBS, NUMBERED or 1100 word pattern. In Numbered mode, each timeslot contains the pattern 0NNNNNNX where NNNNNN is the binary number of the TU. The least significant digit (X) is alternated between 0 and 1 in successive frames.	TU-12, TU-11 Mapping or TU-3 Word (8 bit user programmable word).
TU-11 (DS1) Unframed	TU-11 structure, D4 framed DS1 with 2E15-1, 2E9-1 PRBS or 1100 Word pattern in other TU-11s.	TU-12, TU-11 Mapping or TU-3 Word (8 bit user programmable word).
TU-11 (DS1) Framed	TU-11 structure, framed with 2E15-1, 2E9-1 PRBS, NUMBERED or 1100 word pattern in other TU-11s. In Numbered mode, each timeslot contains the pattern 1NNNNNN1 where NNNNNN is the binary number of the TU. Framing type will be the same as the foreground except when SLC96 is selected. In this case, D4 framing is inserted in the background	TU-12, TU-11 Mapping or TU-3 Word (8 bit user programmable word).

Appendix B

ETSI/ANSI Terminology

A table of ETSI terms with their ANSI equivalents.

ETSI/ANSI Conversion and Equivalent Terms

Introduction

The terminology used on the instrument display can be ETSI (SDH) or ANSI (SONET) terminology. Refer to the table given in this appendix for an explanation of equivalent SDH/SONET terms.

ETSI: European Telecommunications Standards Institute.

ANSI: American National Standards Institute.

Table 9 ETSI / ANSI Terminology

ETSI Term	ANSI Term
AU-3	STS-1 SPE + H1, H2, H3
AU-4	STS-3c SPE + H1, H2, H3
BIP (Bit Interleaved parity)	CV (Code Violation)
High Order Path (HP / HO)	STS Path
I-n Intra Office, (n=STM-n level)	Intermediate Reach (IR)
L-n.1 or L-n.2 long haul	LR long reach
Low Order Path (LP / LO)	VT Path
LP-REI	REI-V
M.S.P	A.P.S
Multiplexer Section (MS)	Line
Multiplexer Section Protection	Automatic Protection Switching
MS-AIS	Line AIS / AIS-L
MS-BIP	Line CV / CV-L
MS-DCC	Line DCC / DCC-L
MS-REI	Line FEBE / REI-L

ETSI/ANSI Terminology
ETSI/ANSI Conversion and Equivalent Terms

Table 9 **ETSI / ANSI Terminology , continued**

ETSI Term	ANSI Term
MS-RDI	Line FERF / RDI-L
Multiplexer Section Overhead	Line Overhead
Network Node Interface	Line Interface
OOF	SEF (severely errored frame defect)
Path AIS / AU-AIS	AIS-P
Path REI / HP REI	REI-P
Path FERF / HP RDI	RDI-P
Path IEC / AU-IEC	IEC-P
Path Overhead	Path Overhead
Regenerator	Repeater
Regenerator Section (RS)	Section
Regenerator Section Overhead	Section Overhead
Remote Alarm Indicator	RAI
RS-DCC	Section DCC (DCC-S)
Section Overhead (SOH)	Transport Overhead (TOH)
S-n.1 or S-n.2 short haul	Short Reach (SR)
SOH	TOH
STM-m	OC-n / STS-n (where $m = n \div 3$ for $m \geq 1$)
STM-0	STS-1
STM-1	OC3c / STS-3c
STM-4	OC-12 / STS-12
STM-16	OC-48 / STS-48
Tributary Unit (TU)	Virtual Tributary (VT)

ETSI/ANSI Terminology
ETSI/ANSI Conversion and Equivalent Terms

Table 9 **ETSI / ANSI Terminology , continued**

ETSI Term	ANSI Term
TU	VT
TU-11	VT 1.5
TU-12	VT 2
TU-2	VT 6
TU-3	NONE
TU BIP	VT BIP (CV-V)
TU RDI / LP-RDI	RDI-V
TUG	VT Group
TUG2	VT Group (12 columns)
TUG3	VT Group (86 columns)
TU multiframe	VT superframe
TU PATH AIS	VT AIS (AIS-V)
VC	SPE
VC4	STS-3c
Virtual Container (VC)	Synchronous Payload Envelope (SPE)

NOTE: VC is an ETSI abbreviation for Virtual Container and an ETSI / ANSI abbreviation for (ATM) Virtual Channel. The context of VC must therefore be taken into account when converting between standards.

Appendix C

Glossary of Terms

A brief explanation of abbreviations used in the OmniBER 718.

Glossary

A		BPV	Bipolar Violation
AAL	ATM Adaptation Layer	C	
ABR	Available Bit Rate	CAS	Channel Associated Signaling
ADDF	Automatic Digital Distribution Frame	CBR	Constant Bit Rate
ADM	Add Drop Multiplexer	CCITT	Consultative Committee on International Telegraphy and Telephony
ADPCM	Adaptive Differential Pulse Coded Modulation	CCS	Common Channel Signaling
AIM	ATM Inverse Multiplexer	CDT	Cell Delay Tolerance
AIS	Alarm Indication Signal	CDV	Cell Delay Variation
AMI	Alternate Mark Inversion	CEPT	Committee of European PTTs
ANSI	American National Standards Institute	CMI	Coded Mark Inversion
APS	Automatic Protection Switching	CO	Central Office
ASCII	American Standard Code for Information Interchange	Contiguous	Adjacent or next.
ATM	Asynchronous Transfer Mode	CPE	Customer Premises Equipment
AU	Administrative Unit	CRC	Cyclic Redundancy Check
AU-AIS	AU Pointer Justification Event	CSES	Consecutive Severely Errored Seconds
AU-LOP	Loss of AU Pointer	D	
AU-NDF	AU Pointer New Data Flag	D/I	Drop and Insert
B		DACS	Digital Access and Cross-connect Switches
BBER	Background Block Error Ratio	Datagram	Unit of data exchanged between a pair of internet modules.
BC	Background Channel	dB	Decibel
BCD	Binary Coded Decimal	DCC	Data Communications Channel
BER	Bit Error Rate	DCS	Digital Cross-connect Switches
BERT	Bit Error Rate Testing		
BIP	Bit Interleaved Parity		
BPS	Bits Per Second		

Glossary of Terms

DDF	Digital Distribution Frame	H	
DDN	Digital Data Network	HDB3	High Density Bipolar 3
DTMF	Dual Tone Multifrequency Signaling	Header	Control information at the beginning of a message, datagram or block of data.
DF	The Don't fragment bit carried in the flags field	HDLC	High-level Data Link control protocol (layer2)
DWDM	Dense Wave Division Multiplexing	HEC	Header Error Control
DXC	Digital Cross Connect	HO Path RAI	High Order Path Remote Alarm Indication
E			
EB	Error Block	HO PTE	High Order Path Terminating Equipment
EOW	Engineering Orderwire	HO	High Order
ES	Error Seconds	HP-IB	Hewlett-Packard Interface Bus (IEEE 488)
ESF	Extended Superframe Format	HP-PLM	High Path Payload Label Mismatch
ESR	Errored Second Ratio	HP-RDI	High Path Remote Defect Indication
ETSI	European Telecommunications Standards Institute	HP-REI	High Path Remote Error Indication
F		HP-TIM	High Path Trace Identifier Mismatch
FAS	Frame Alignment Signal	HP-UNEQ	High Path Unequipped
FC	Foreground Channel	Hz	Hertz (cycles per second)
FCS	Frame Check sequence	I	
FDDI	Fiber Distributed Data Interface	ICMP	Internet Control Message Protocol
FEAC	Far End Alarm Channel	IHL	The internet header field. Internet header length is the header length measured in 32 bit words.
FEBE	Far End Block Error	IP	Internet Protocol
FEC	Forward Error Connection	ISDN	Integrated Services Digital Network
FERF	Far End Receive Failure		
Flags	An internet header field carrying control flags.		
G			
GUI	Graphical User Interface		

Glossary of Terms

ISO	International Standards Organization	MS-REI	Multiplex Section Remote Error Indication
ITU	International Telecommunications Union	MTBF	Mean Time Between Failures
L		MTIJ	Maximum Tolerance Input Jitter
LAN	Local Area Network	MUX	Multiplexer
LCP	Link Control Protocol	N	
LO	Low Order	NDF	New Data Flag
LOF	Loss of Frame	NE	Network Element
LOP	Loss of Path	NFAS	Non Frame Alignment Signal
LOS	Loss of Signal		
LP-PLM	Low Path Payload Label Mismatch	O	
LP-RDI	Low Path Remote Defect Indication	OAM	Operations, Administration and Maintenance
LP-REI	Low Path Remote Error Indication	OC	Optical Carrier
LP-RFI	Low Path Remote Failure Indication	Octet	An eight bit byte.
LP-TIM	Low Path Trace Identifier Mismatch	OH	Overhead
LP-UNEQ	Low Path Unequipped	OLTU	Optical Line Terminal Unit
LSB	Least Significant Bit	OOF	Out of Frame
LTE	Line Terminal Equipment	OS	Operations System
LTM	Line Terminal Multiplexer	P	
M		P/AR	Peak-to-Average Ratio
MF	The more- fragments flag carried in the internet headers flag field.	PBX	Private Branch Exchange
MS	Multiplex Section	PC	Personal Computer
MS-AIS	Multiplex Section AIS	PCM	Pulse Code Modulation
MSOH	Multiplex Section Overhead	PCN	Personal Communications Network
MS-RDI	Multiplex Section Remote Defect Indication	PCR	Peak Cell Rate
		PDH	Plesiochronous Digital Hierarchy
		PES	Percentage Error Second
		POH	Path Overhead

Glossary of Terms

PPP	Point-to-Point Protocol	S	
POS	Packet Over SONET/ SDH	S/N	Signal to Noise Ratio
POTS	Plain Old Telephone Service	SCPI	Standard Commands for Programmable Instrumentation
PRBS	Pseudo Random Binary Sequence	SDH	Synchronous Digital Hierarchy
PSN	Packet Switched Network	SDXC	Synchronous Digital Cross Connect
PSTN	Public Switched Tele- phone Network	SEF	Severely Errored Frame
PT	Payload Type	SES	Severely Errored Second
PTT	Public Telephone and Telegraph	SESR	Severely Errored Seconds Ratio
PTE	Path Terminating Equipment	SF	Super Frame
PU	Physical Unit	SOH	Section Overhead
Q		SONET	Synchronous Optical Network
QoS	Quality of Service	SPE	Synchronous Payload Envelope
R		STE	Section Terminating Equipment
RAI	Remote Alarm Indica- tion	STM	Synchronous Transport Module
RDI	Remote Defect Indica- tion	STS	Synchronous Transport Signal
REBE	Remote End Block Error	SUT	System Under Test
REI	Remote Error Indica- tion	T	
RF	Radio Frequency	TCP	Transmission Control Protocol.
RS	Regenerator Section	TDM	Time Division Multi- plexing
RSOH	Regenerator Section Overhead	TDMA	Time Division Multiple Access
RSTE	Regenerator Section Terminating Equipment	TE	Terminal Equipment
RS-TIM	Regenerator Section Trace Identifier Mismatch		
RX	Receiver		

Glossary of Terms

Time to Live	An internet header field which indicates the upper bound on how long a particular internet datagram may exist.
TMN	Telecommunications Management Network
TOH	Transport Overhead
TU	Tributary Unit
TU-AIS	TU Alarm Indication Signal
TUG	Tributary Unit Group
TU-LOM	TU Loss of Multiframe
TU-LOP	Loss of TU Pointer
TU-NDF	TU Pointer New Data Flag
TX	Transmitter
U	
UI	Unit Interval
V	
VBR	Variable Bit Rate
VC	Virtual Channel
VC-n	Virtual Container
VP	Virtual Path
VT	Virtual Tributary
VXI	VMEbus Extensions for Instrumentation
W	
WAN	Wide Area Network
WDM	Wave Division Multiplexing

Index

Numerics

- 156MTS Compatibility, 310
- 156MTS compatibility, 310
- 7,4,1 Lengths
 - IP datagram, 191

A

- A1A2 Boundary Function, 61
- Accessories
 - Connection, 20
- Adding ATM Errors, 167
- Alarm scan
 - PDH, 128
 - SDH, 127
- Alarms
 - POS, 195
- Alarms - TCM, 231
- Alarms & errors
 - PDH add, 83
 - PDH payload add, 83
 - SDH add, 82
- Analysis measurement
 - PDH, 115
 - PDH payload, 115
 - SDH, 114
- APS messages
 - generation, 99
 - monitoring, 57
 - test function, 99
- ATM Alarms, 165
 - measurement, 179
- ATM Delay Performance, 176
- ATM Errors, 167
- ATM Operation, 153
- ATM Payloads, 154
 - Receiver, 170
- ATM Results, 169
- ATM Service Disruption, 180
- ATM signal Receiver, 172
- AU-3 Background Patterns, 326
- Automatic protection switch
 - message generation, 99
- Autotolerance, 137

B

- B/G mapping selection SDH, 30
- Background Distributions, 162
- Background mapping selection SDH, 30

- Background Patterns, 326
- Background Traffic, 161
- Beep on received error, 309
- Brightness, 316

C

- Capture overhead, 62
- Centronics printer, 267
- Channelized Testing, 202
- Codes, 84
- Cold Start, 21
- Color, 315
- Color control for error threshold indication, 315
- Concatenated Payloads, 29
- Configuration
 - copy from disk to instrument, 300
 - copy from instrument to disk, 298
 - recall from disk, 296
 - recall from instrument, 280
 - store in instrument, 278
 - store on disk, 295
- Connecting
 - Accessories, 20
 - ESD Precautions Necessary, 16
 - To the Network, 16
- Connectors
 - Optical Interface, 16
- Continuity Test, 212
- Conventions, 15
- Convergence Sublayer, 157
- Copy configuration
 - from disk to instrument, 300
 - from instrument to disk, 298
- Coupling, 306
- Create directory, 283

D

- Datagram Length, 190
- Date & time, 307
- DCC
 - drop, 104
 - insert, 104
- DCC Insert test function, 104
- Delay time, jitter tolerance, 139, 223
- Delete
 - directory, 288
 - file, 287

Directory

- create, 283
 - delete, 288
 - management, 283
- ## Disk
- accessing a directory, 284
 - accessing files, 284
 - adding descriptors to files, 289
 - copy configuration from instrument, 298
 - copy configuration to instrument, 300
 - copy graphics results from instrument, 302
 - create directory, 283
 - delete directory, 288
 - delete file, 287
 - format a disk, 281
 - label a disk, 282
 - managing directories, 283
 - managing files, 283
 - recall configuration, 296
 - recall graphics results, 297
 - rename a file, 286
 - save data logging, 294
 - save graphics results, 290
- ## Downstream Alarms, 165
- ## Drop
- DCC, 104
 - external payload/test signal, 79
- ## DS1 Loop Codes, 105
- ## DSn THRU mode, 28
- ## Dwell time, jitter tolerance, 139, 223

E

- enhance results, 315
- Error Add - TCM, 230
- Error Burst Definition
 - Service Disruption, 122
- Error Indication
 - Audio setting, 309
- Error threshold indication
 - setting, 315
- Error threshold, jitter tolerance, 140, 223
- Errors & alarms
 - PDH add, 83
 - PDH payload add, 83
 - SDH add, 82
- Errors and alarms PDH test function, 83
- Errors and alarms SDH test function, 82

Index

- ESD Precautions
 - For the Service Engineer, 16
- Exercising POS Hardware, 204
- Extended Jitter
 - measurement, 131
- Extended jitter
 - receive interface, 51
- External
 - payload/test signal drop, 79
 - payload/test signal insert, 76
- External printer
 - connecting to parallel port, 272
- F**
- F/G mapping selection SDH, 30
- FEAC, 84
- FEAC codes, 84
- File
 - accessing, 284
 - delete, 287
 - descriptors, 289
 - management, 283
 - rename, 286
- Foreground Distributions, 162
- Foreground mapping selection SDH, 30
- Foreground Traffic, 159
- Format a disk, 281
- Frame Check Sequence, 187
- Frequency measurement, 116
- Frequency offset
 - PDH, 66
 - SDH, 64
 - SDH line rate, 64
 - SDH tributary, 65
- Front panel soft recovery, 21
- Full Frame Overwrite Mode, 28
- Functional Tests (Smart Test), 41
- G**
- G.783 Pointer Sequences, 89
- G.821 analysis measurement, 115
- G.826 analysis measurement, 115
- Glossary of terms, 334
- Graph storage resolution, 314
- Graphics
 - copy results from instrument to disk, 302
 - logging displays, 251
 - recall results from disk, 297
 - recall stored results, 245
 - saving results to disk, 290
 - saving to instrument, 244
 - storage resolution, 244
 - viewing error & alarm summaries, 249
 - viewing the bar graphs, 247
- H**
- H4 byte
 - sequence setting, 55
- HANDSET Connector, 20
- HDLC Frame Stuffing, 218
- HDLC Framing, 187
- Header
 - IP, 192
- HEC Function, 168
- HP path label monitoring, 57
- HP-IB printer, 268
- I**
- In-band DS1 loop code, 310
- In-band Loop codes, 105
- Insert
 - DCC, 104
 - external payload/test signal, 76
- Internal printer
 - change paper, 273
 - logging, 269
 - print head cleaning, 276
- IP addresses, 193
- IP Header, 192
- IP Packet Length, 190
- IP Payload, 194
- J**
- J1, J2 bytes
 - setting, 55
- Jitter, 148
 - extended, 131
 - measurement, 129, 131
 - receive interface, 50, 51
 - transmit interface, 34
- Jitter mask, 317, 319
- Jitter Tests (Smart Test), 41
- Jitter tolerance
 - delay time, 139, 223
 - dwelt time, 139, 223
 - error threshold, 140, 223
 - graph result, 140, 224
 - logging results, 264
 - measurement, 137
 - number of points, 139, 223
 - text result, 140, 224
- Jitter transfer
 - accuracy, 142
 - calibration, 144
 - delay time, 145
 - dwelt time, 145
 - graph results, 147
 - input mask, 145
 - logging results, 266
 - measurement, 142
 - number of points, 145
 - Q factor, 145
- K**
- Keyboard lock, 308
- L**
- Labeling a disk, 282
- Labels Overhead, 59
- Labels, overhead monitoring, 57
- Laser apertures
 - Location, 17
- LID Connector, 20
- Location of Laser Apertures, 17
- Lock keyboard, 308
- Locking the Mask
 - Jitter, 318
- Logging
 - device, 251, 261, 264, 266
 - error event, 253
 - graph displays, 251
 - jitter tolerance results, 264
 - jitter transfer results, 266
 - on Demand, 261
 - Overhead Capture, 261
 - overhead snapshot, 261
 - Pointer Graph, 261
 - results, 253
 - results snapshot, 261
 - SDH Tributary Scan, 261
 - test period, 253
 - to Centronics printer, 267
 - to disk, 294
 - to HP-IB printer, 268

Index

to internal printer, 269
to RS-232-C printer, 270
Loop Codes, 105

M

M2100 analysis measurement, 115
M2110 analysis measurement, 115
M2120 analysis measurement, 115
Managing
 disk directories, 283
 disk files, 283
Measuring
 extended jitter, 131
 frequency, 116
 jitter, 129
 jitter tolerance, 137
 jitter transfer, 142
 optical power, 117
 overhead BER, 110
 PDH analysis, 115
 round trip delay, 118
 SDH analysis, 114
 service disruption, 121
 wander, 133

Monitor

 equalizer, 47
 indicator, 47
 receive overhead, 56

MSOH

 capture and display, 62
 insertion, 60

MSP messages

 generation, 99
 monitoring, 57
 test function, 99

MS-REI enable, 312, 313

MS-REI Result enable, 312, 313

Multiplexer section overhead

 capture and display, 62
 insertion, 60

O

Optical

 clock stress, 97
 power measurement, 117

OPTICAL IN Connector, 18

Optical Interface Connectors, 16

OPTICAL OUT Connector, 18

Out-of Band Loop Code, 105

Overhead

 all data, 54
 all labels, 55
 APS messages monitoring, 57
 BER test, 110
 capture, 62
 default transmit, 54
 H4 byte sequences, 55
 Labels monitoring, 57
 monitor receive, 56
 path monitor, 57
 path transmit, 55
 sequence generation, 60
 SOH monitor, 56
 SOH transmit, 54
 trace messages, 58
 transmit, 54
Overhead capture
 trigger, 62
Overhead capture test function, 62
Overhead Labels, 59
Overhead sequence
 repeat run, 60
 single run, 60

P

Packet Rate, 191

Packet Size, 209

Paper change

 internal printer, 273

Parallel port

 connecting Centronics printer, 272

Path overhead

 capture and display, 62
 insertion, 60

Payload

 analysis measurement, 115
 errors & alarms, 83
 framing SDH transmit, 32
 framing, SDH receive, 49
 insert external, 76
 N X 64 kb/s receive, 75
 N X 64 kb/s transmit, 73
 PDH receive, 48
 PDH transmit, 27
 SDH receive, 49, 72
 SDH transmit, 32, 70

 spare bits, 86

 Payload ATM, 154

 Payload PoS, 185

Payloads

 ATM Receiver setup, 170

PDH

 alarm scan, 128
 analysis measurement, 115
 errors & alarms, 83
 external test signal drop, 79
 external test signal insert, 76
 frequency measurement, 116
 frequency offset, 66
 N X 64 kb/s test signal receive, 75
 N X 64 kb/s test signal transmit, 73
 payload, receive, 48
 payload, transmit, 27
 receive interface, 47
 spare bits, 86
 structured test signal receive, 72
 structured test signal transmit, 70
 transmit interface, 26

POH

 capture and display, 62
 insertion, 60
 monitor, 57
 setting, 55

Pointer adjustments

 burst, 88
 G.783, 89
 new pointer, 88
 offset, 88

Pointer adjustments test function, 87

Pointer graph, 95

Pointer graph test function, 95

Pointer Sequences, 91

Policing ATM Traffic, 174

POS Alarms, 195

POS Errors, 196

PoS Operation, 183

POS Payload Mappings, 186

POS Payloads, 185

 receiver, 197

POS Smart Test, 46

PPP in HDLC-like framing, 187

Precautions

 ESD when connecting, 16

Print head cleaning, 276

Index

- Printer
 - Centronics, 267
 - Centronics, connecting to parallel port, 272
 - Centronics, logging to, 267
 - HP-IB, logging to, 268
 - internal, changing paper, 273
 - internal, cleaning print head, 276
 - internal, logging to, 269
 - RS-232-C, logging to, 270
- Printer HP-IB, RS232, PARALLEL ONLY Connector, 20
- Printing results from disk, 271
- Protocol Stack, 184

- R**
- Random Lengths
 - IP datagram, 191
- Random packet gap, 205
- Recall
 - configuration from disk, 296
 - configuration from instrument, 280
 - graphics results from disk, 297
 - stored graph results, 245
- Receive interface
 - extended jitter, 51
 - jitter, 50, 51
 - PDH, 47
 - SDH, 49
 - wander, 52
- Receive settings
 - Coupled to transmit, 306
- Receiver ATM signal, 172
- Regenerator section overhead
 - capture and display, 62
 - insertion, 60
- Remote Control HP-IB, RS232, 10 BASE -T Connector, 20
- Rename a file, 286
- Resolution, 314
- Result, 312, 313
- Results
 - ATM, 169
 - POS, 200
- Results Definitions
 - Trouble Scan, 112
- Round trip delay, 118
- RS-232-C
 - logging to printer, 270
- RSOH
 - capture and display, 62
 - insertion, 60
- Rx set up TCM, 232

- S**
- S1 sync status monitoring, 57
- Save
 - configuration to disk, 295
 - data logging to disk, 294
 - graphics results to disk, 290
 - graphics results to instrument, 244
 - Screen dump to disk, 292
- Scrambling, 187, 188
- Screen brightness/color, 316
- Screen dump save to disk, 292
- SDH
 - alarm scan, 127
 - analysis measurement, 114
 - APS messages, 99
 - DCC insert, 104
 - errors & alarms add, 82
 - external payload drop, 79
 - frequency measurement, 116
 - frequency offset, 64
 - line rate offset, 64
 - Mapping selection, 30
 - MSP messages, 99
 - N X 64 kb/s payload receive, 75
 - N X 64 kb/s payload transmit, 73
 - optical clock stress, 97
 - optical power measurement, 117
 - overhead BER test, 110
 - overhead capture, 62
 - overhead monitor, 56
 - overhead sequences, 60
 - overhead trace messages, 58
 - overhead transmit, 54
 - payload, receive, 49
 - payload, transmit, 32
 - pointer adjustments, 87
 - pointer graph, 95
 - receive interface, 49
 - service disruption measurement, 121
 - structured payload receive, 72
 - structured payload transmit, 70
 - thru mode, 38
 - transmit interface, 29
 - tributary rate offset, 65
 - tributary scan, 124
- Self test, 321
- Sequence generation test function, 60
- Sequences
 - Overhead generation, 60
- Service Disruption
 - ATM, 180
 - POS, 215
- service disruption
 - DS1 and DS3, 122
- Service disruption measurement, 121
- Setting up Signaling Bits, 67
- Settings (Smart Test), 41
- Short term period selection, 111
- Signal, 44
- Signal Loss
 - suspending test on, 311
- Signal Quality (Smart Test), 41, 44, 46
- Signaling Bits
 - D4 and SLC-96 payloads, 120
 - ESF Payload, 120
 - Monitoring, 120
- Signaling bits
 - setting up, 67
- Smart Setup, 41
- Smart Test, 41
- SOH
 - Monitoring, 56
 - Setting, 54
- Spare bits, 86
- Spare bits test function, 86
- storage graph, 314
- Store
 - configuration in instrument, 278
 - configuration on disk, 295
- Stress test test function, 97
- Suspending Test on Signal Loss, 311
- Suspending test on signal loss, 311
- Synchronization source
 - SDH, 30, 186

- T**
- Tandem Connection, 226
- Tandem Connection Monitoring, 226
- Tandem Connection Terminating Equipment (TCTE) Testing, 237

Index

-
- TCM Access Point Identifier, 228
 - TCM Alarms, 231
 - TCM APId messages, 233
 - TCM APId messages - detect, 233
 - TCM Errors, 230
 - TCM Test Capability in OmniBER, 226
 - TCM Tx Set up, 227
 - TCTE Sink/Source Testing, 242
 - TCTE Source Testing, 237
 - Test Cell, 160
 - Test function
 - APS messages, 99
 - DCC insert, 104
 - errors & alarms PDH, 83
 - errors & alarms SDH, 82
 - MSP messages, 99
 - overhead BER test, 110
 - overhead capture, 62
 - pointer adjustments, 87
 - pointer graph, 95
 - sequence generation, 60
 - spare bits, 86
 - stress test, 97
 - tributary scan, 124
 - Test period selection, 111
 - Test signal
 - drop external, 79
 - insert external, 76
 - N X 64kb/s receive, 75
 - N X 64kb/s transmit, 73
 - Test Timing, 111
 - Threshold indication setting, 315
 - Throughput Testing, 208
 - THRU mode (DSn), 28
 - Thru mode SDH, 38
 - Time & date, 307
 - Trace messages, 58
 - Transmit ATM Alarms, 165
 - Transmit interface
 - jitter, 34
 - PDH, 26
 - SDH, 29
 - wander, 36
 - Transmit settings
 - Coupled to Receive, 306
 - Tributary, 148
 - Tributary Jitter, 148
 - Tributary scan, 124
 - Trigger Output, 324
 - Trouble Scan, 112
 - TUG-3 Background Patterns, 327
- U**
- Upstream Alarms, 165
 - User defined, 319
 - User Length
 - IP datagram, 190
- V**
- VGA Connector, 20
 - Viewing
 - bar graphs, 247
 - graphics error & alarm summaries, 249
 - Viewing ATM Results, 169
 - Viewing TCM Errors and Alarms, 235
 - Voice channel
 - round trip delay, 118
- W**
- Wander
 - bar graph, 135
 - measurement, 133
 - receive interface, 52
 - transmit interface, 36
 - Wander reference
 - SDH, 30, 186
 - warning symbols, 17
-

Index

About This Edition

This edition of the OmniBER 718 PDH/DSn/SDH/POS User Guide documents the product as of September 2000.

© Copyright Agilent Technologies. All rights reserved. Reproduction, adaptation, or translation without prior written permission is prohibited, except as allowed under the copyright laws.

Sales and Service Offices

An up-to-date list of Agilent Offices is available through the Agilent Website at URL:
<http://www.agilent.com>.

Product Notes/White Papers on ATM/POS Operation

Refer to the Agilent Website at URL.
<http://www.agilent.com>
for access to the following Product Notes.

- ATM error performance testing, 5968-9885E.
- Verifying the policing functions in the ATM network, 5968-9884E.
- Physical layer jitter testing in an ATM environment, 5968-9883E.
- Measuring service disruption times in high speed ATM networks, 5968-9137E.
- Packet Over SONET/SDH (White Paper), 5980-2027E.
- Packet Over SONET/SDH Functional Testing, 5980-2376E.
- Tandem Connection Monitoring, 5980-2907

